

ROD 05 "A"

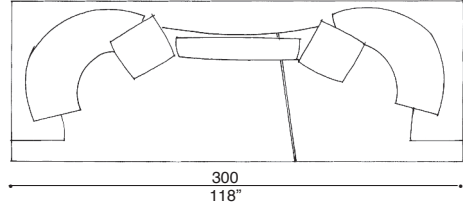

ROD 06 "B"

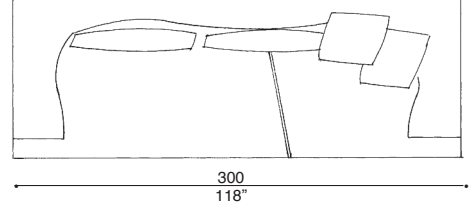

ROD 04 "C"

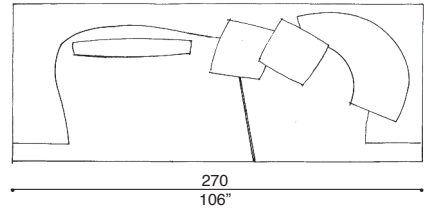

ROD 61 "D"

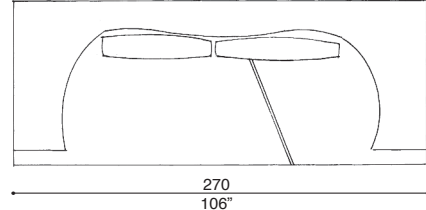

ROD 62 "E"

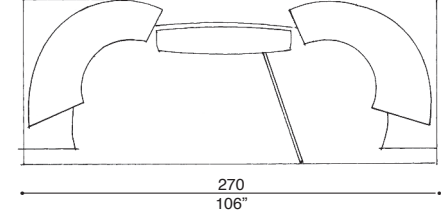

ROD 03

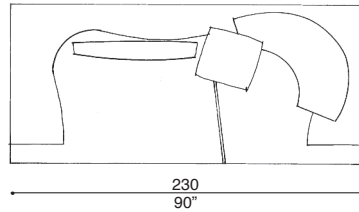

ROD 02

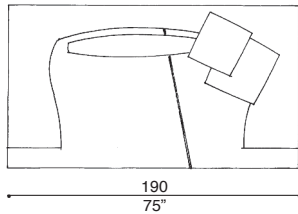

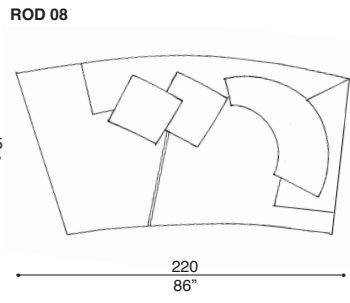
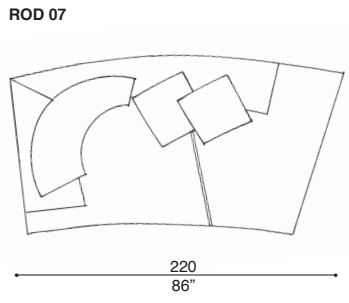
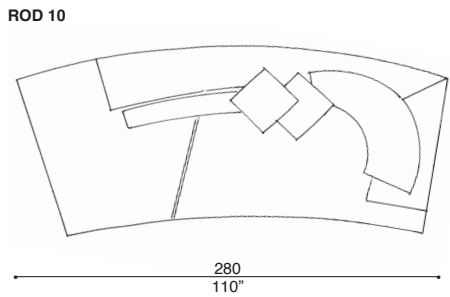
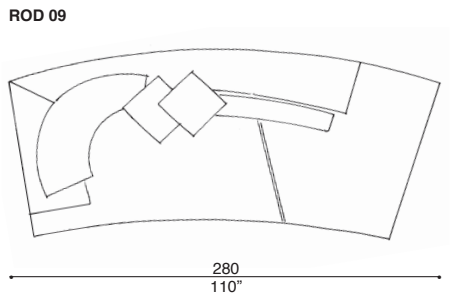
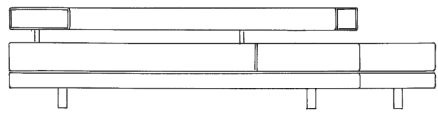
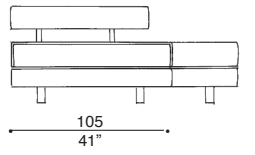
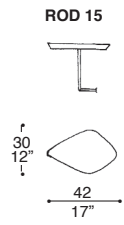
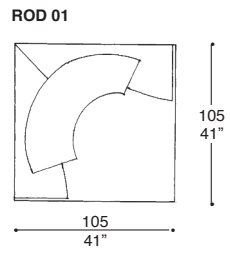
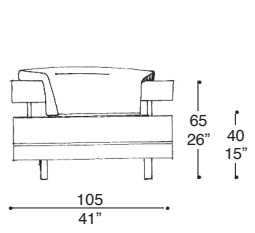

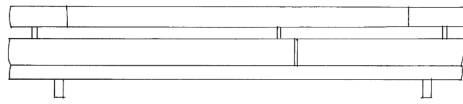
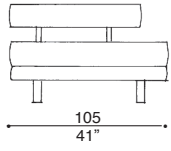

ROD 22

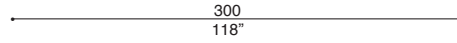
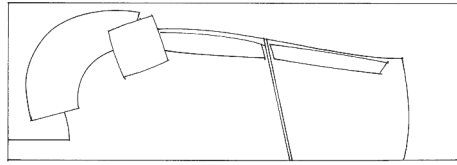

ROD 23

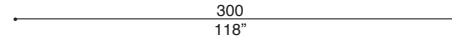
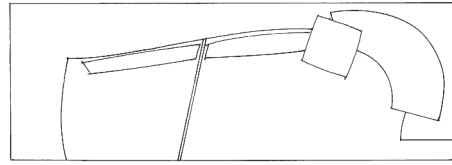

ROD 20

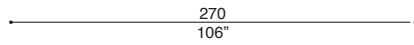
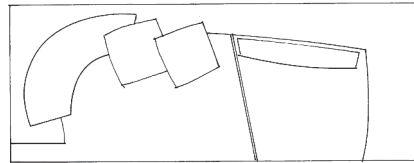

ROD 21

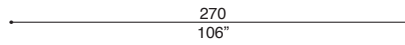
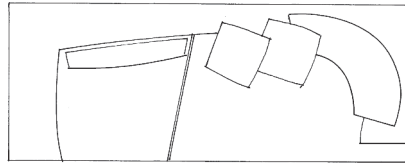

ROD 18

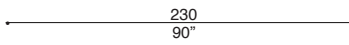
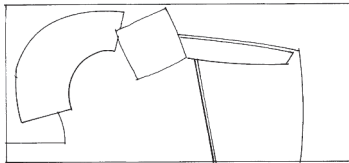

ROD 19

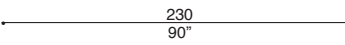
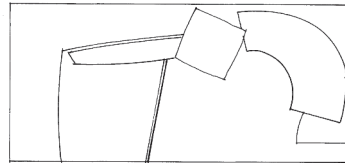

ROD 16

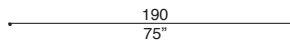
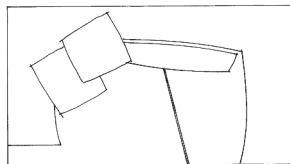

ROD 17

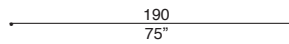
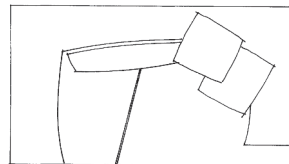

ROD 38

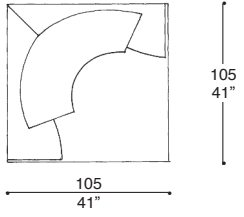

ROD 28

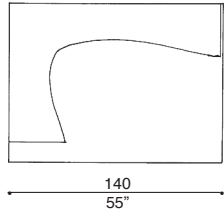

ROD 29

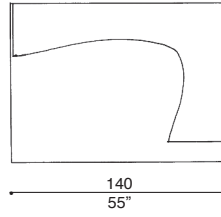

ROD 36

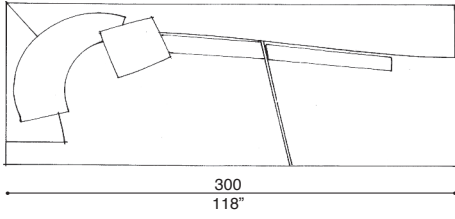

ROD 37

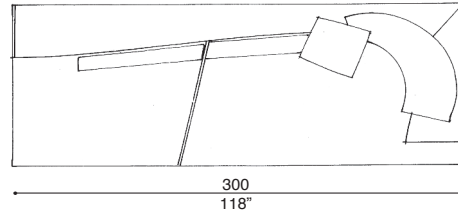

ROD 34

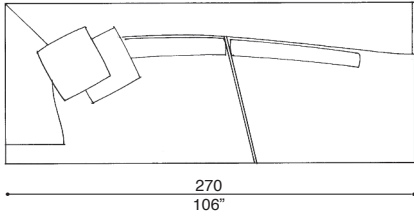

ROD 35

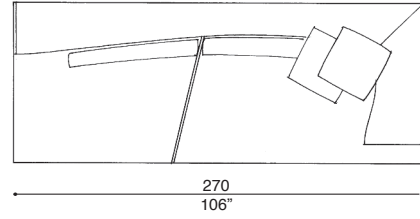

4 ▶

ROD 32

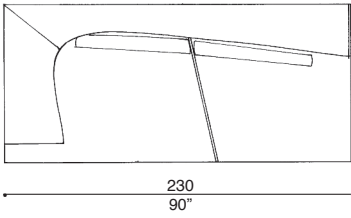

ROD 33

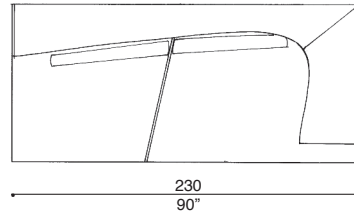

ROD 30

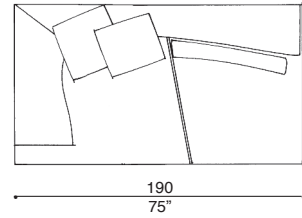

ROD 31

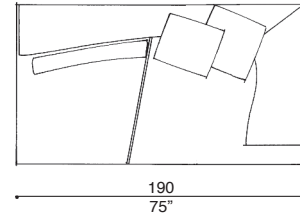

ROD 11

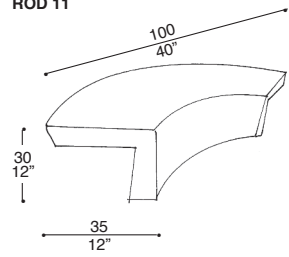

ROD 12

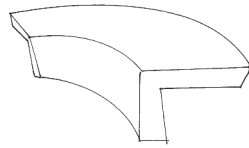

ROD 13

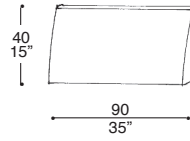

ROD 14

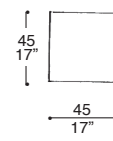

ROD 57

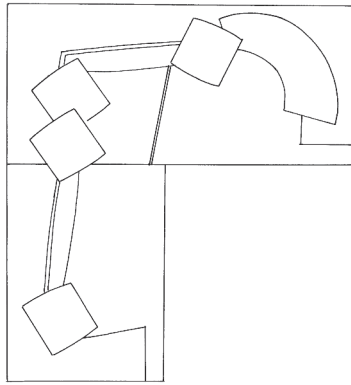

ROD 58

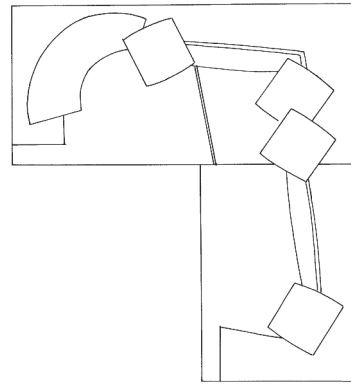

ROD 59

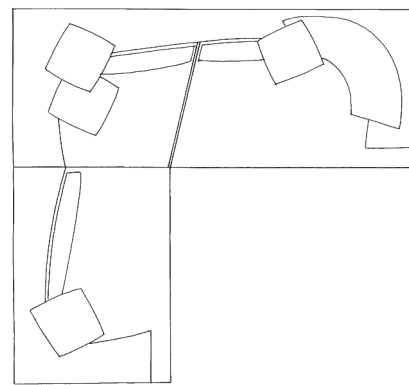

ROD 60

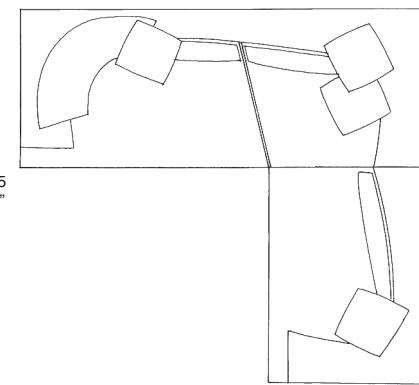

5 ▶

ROD 27

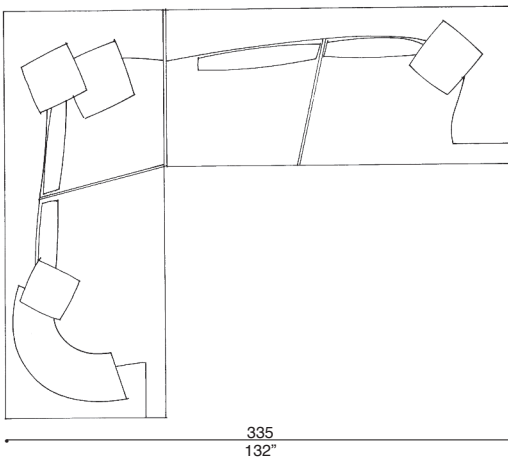

ROD 26

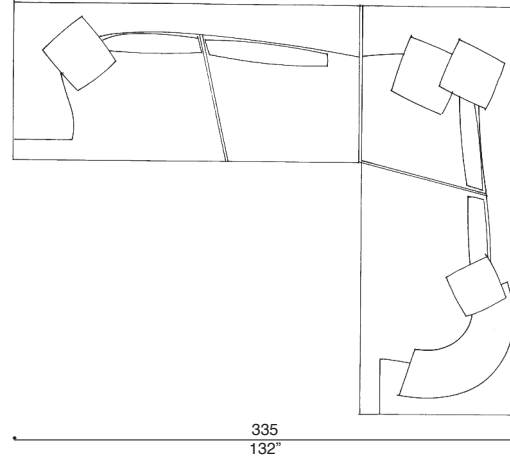

ROD 63

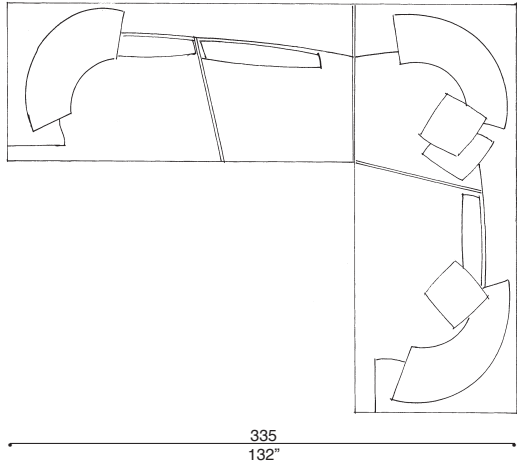

ROD 64

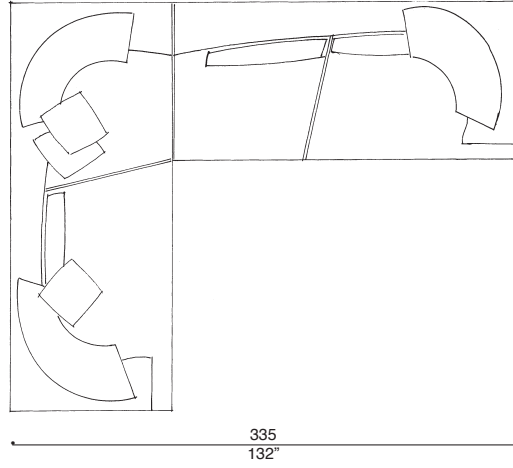

6 ▶

ROD 24

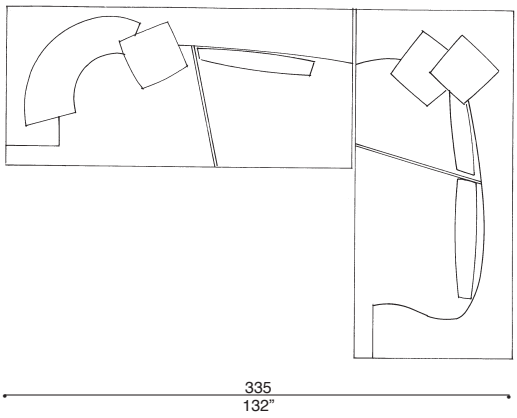

ROD 25

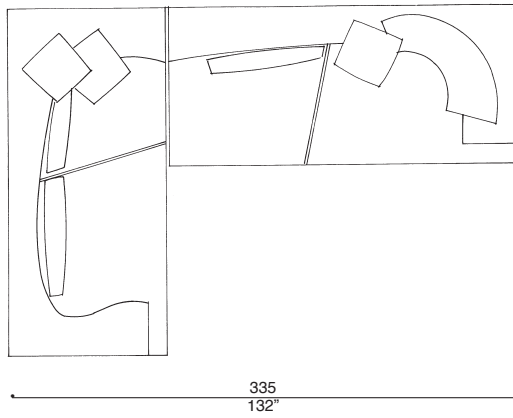

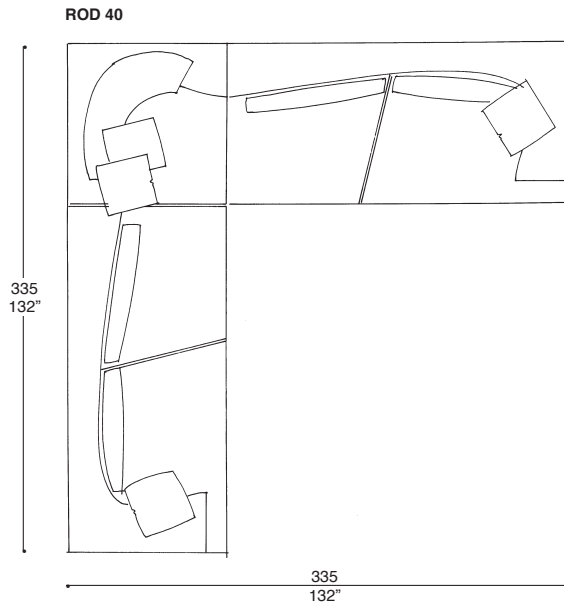
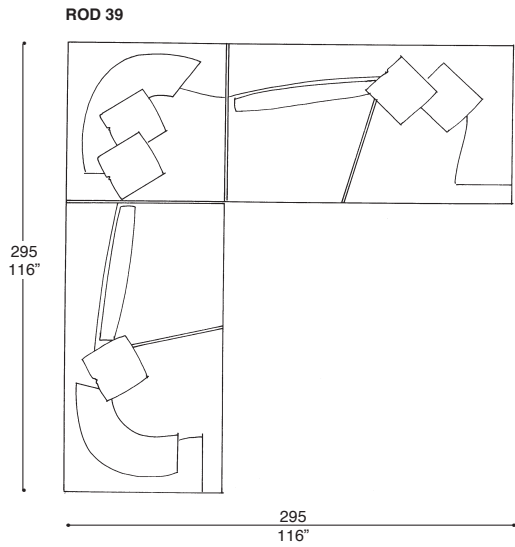

7 ▶

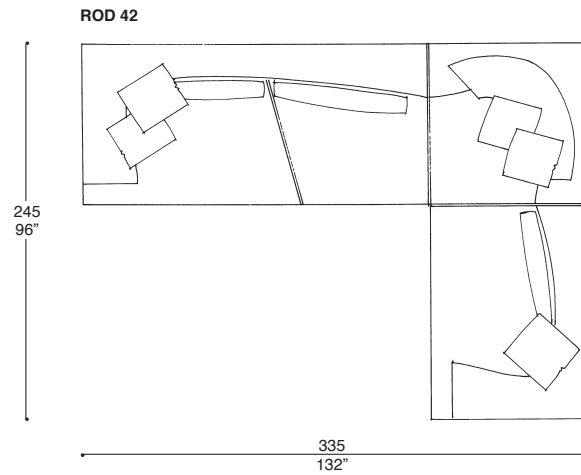
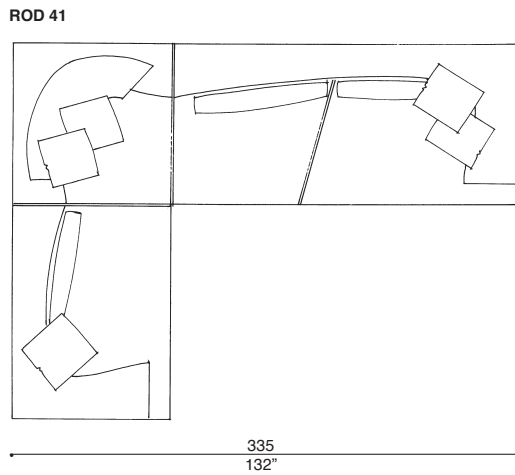

ROD 43

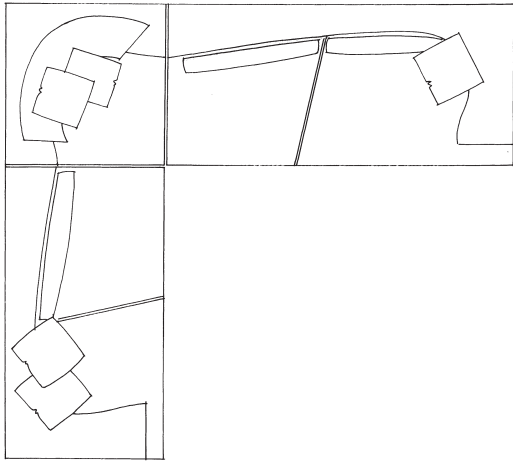

335
132"

ROD 44

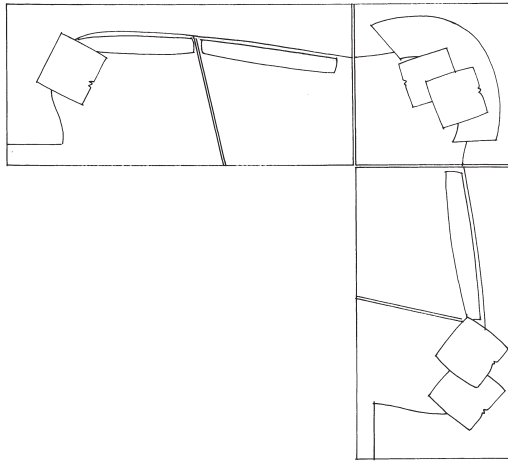

335
132"

295
116"

8 ▶

ROD 45

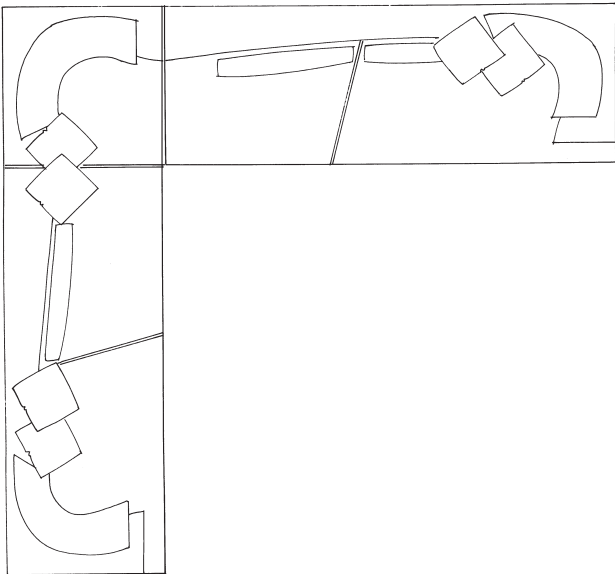

405
159"

ROD 46

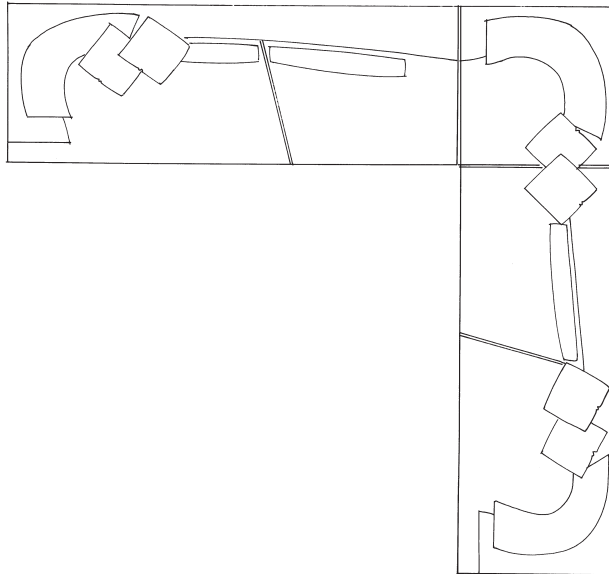

405
159"

375
148"

ROD 51

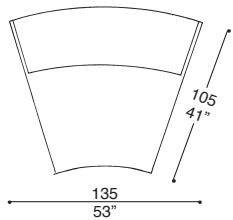

ROD 47

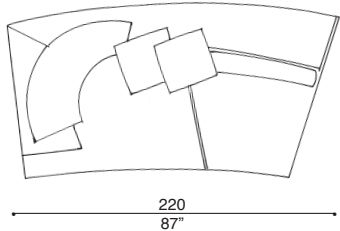

ROD 48

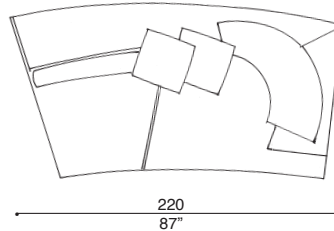

ROD 49

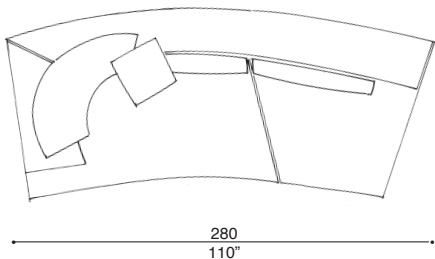

ROD 50

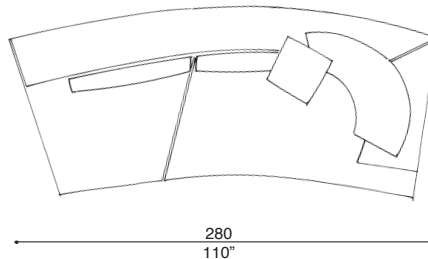

9 ▶

ROD 52

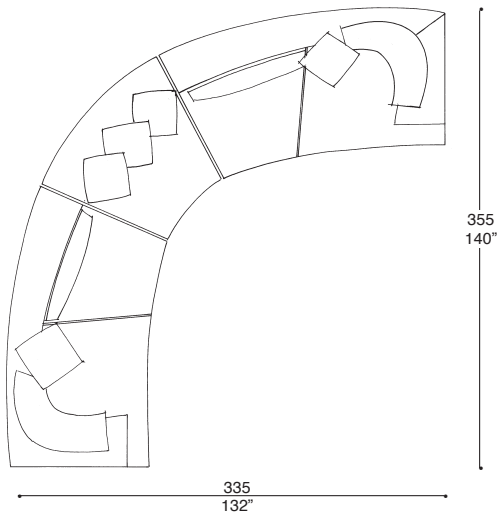

ROD 53

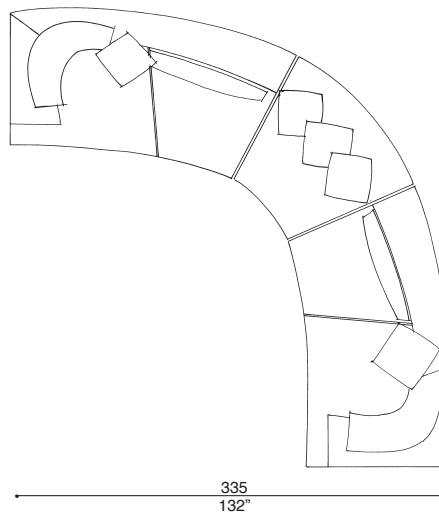

ROD 54

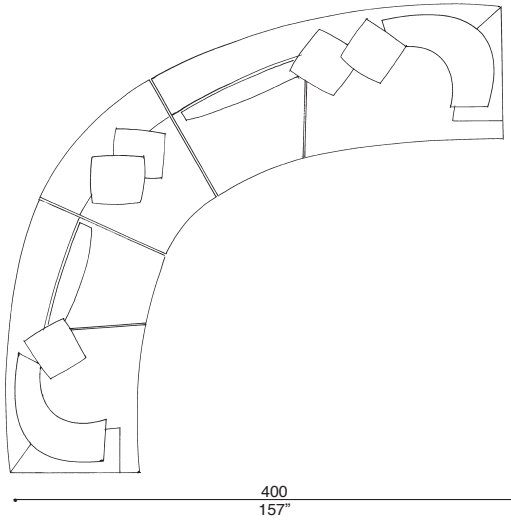

ROD 55

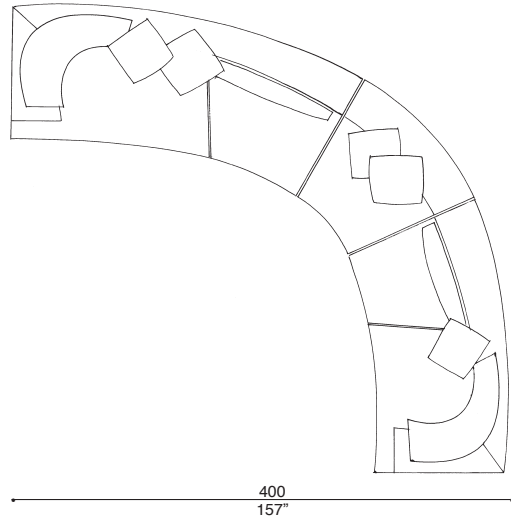

10 ►

ROD 56

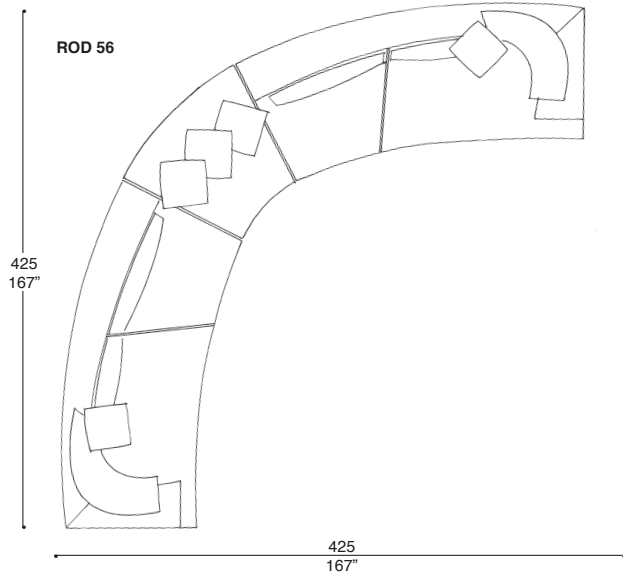

ROD 65

