

Il Loft

2020

COLLECTION

Il Loft

2020

THE TWENTY TWENTY
COLLECTION

2020
COLLECTION



A Creative Mind

Da bambino, ammirava i colori, suoni e sapori della natura. Da adulto, le opere dei grandi architetti: da Gio Ponti e Marco Zanuso a Frank Lloyd Wright, Mies van der Rohe e Oscar Niemeyer.

La ricerca del Bello, in tutte le sue forme, è quello che anima da sempre Giorgio Saporiti. Architetto e designer innamorato del colore ("senza di esso la vita non esiste") ma anche imprenditore e grande conoscitore di tendenze del design e della moda, Giorgio Saporiti è stato definito un'"inesauribile macchina sforna-idee": il suo mondo di tessuti, arredi, complementi e interior sembra infatti rigenerarsi all'infinito, dando vita a creazioni che sono allo stesso tempo di tendenza e evergreen. Le sue forme razionali e pulite ma capaci di emozionare, le sue cromie che si fondono le une con le altre, i suoi accostamenti spesso azzardati ma sempre capaci di creare un'armonia perfetta sono alla base del

When he was a little kid, he used to wonder at the colors, sounds and flavors of nature. As an adult, he was stunned by the masterpieces of great architects such as Gio Ponti and Marco Zanuso, or Frank Lloyd Wright, Mies van der Rohe and Oscar Niemeyer.

The search for Beauty, in all its forms, is what has always motivated Giorgio Saporiti. As an architect and a designer, he is in love with colors ("without them, there is no life"); but his multifaceted nature made it possible for him to be, at the same time, also an excellent entrepreneur as well as a living antenna for design and fashion trends. It does not come as a surprise, then, to hear that Giorgio Saporiti is considered by those who know him "an unstoppable ideas generating machine". His world of fabrics, furniture, and interiors actually seems to regenerate itself infinitely and to give life to creations that have the amazing capacity to be at the same time trendy but evergreen. His rational, pure lines are able to bring out emotions, his color palettes mingle one with the

successo globale de Il Loft, l'azienda da lui creata nel 1994, il cui marchio è riconosciuto in tutto il mondo come araldo della qualità Made in Italy.

La sua ricetta per il successo? "Progettare perché non solo ogni arredo o complemento ma anche ogni spazio sia unico, pensato per il committente a sua immagine e somiglianza. Perché un interior riuscito è uno in cui si è felici di vivere".

"L'ineluttabile ciclo della trasformazione interessa la nostra casa e il mondo attorno a noi. Nell'atto di creazione una cosa mi resta sempre impressa nella mente: occorre raggiungere la perfetta unione con l'interno che costantemente si rinnova".

other, his couplings are often hazardous but always end up providing a perfect harmony.

These are the characteristics that made up the success of the company that Giorgio Saporiti himself created in 1994, Il Loft, a brand that is now universally recognized as a herald of Made in Italy quality.

His recipe for success? "Designing so that all furniture and interior is a reflection of the client's taste and soul. So that he or she is happy to live in it".

"The unavoidable cycle of transformation also challenges our ideas of home. When I create something, I always keep this in mind: interiors will have to be in tune with the ever-changing world around us".

"When I create something, I always keep this in mind: interiors will have to be in tune with the ever-changing world around us"

An authentic artisan experience.

Dall'inesauribile estro creativo di Giorgio Saporiti, interprete unico e originale delle più attuali tendenze tessili, nasce una linea di tessuti tricot realizzati appositamente per vestire le nuove collezioni.

Il risultato è un prodotto di altissima qualità, espressione indiscussa dell'eccellenza del Made in Italy, capace di creare un ponte tra moda e design, come nella più fedele tradizione del marchio Il Loft.

From the illimitable creative genius of Giorgio Saporiti, an inimitable and unique exponent of the very latest textile trends, comes a line of tricot fabrics created especially to "dress" the new collections.

The result? Products of outstanding quality that irrefutably epitomise "Made in Italy" excellence and bridge the gap between fashion and design in true Il Loft tradition.

Handcrafted design

Design 100% italiano e materiali esclusivi, sono questi i leit-motiv ricorrenti in ogni singolo progetto firmato Il Loft: tessuti, arredi, complementi e interior dalle forme pulite e razionali, sempre capaci di stupire ed emozionare. Un modo di fare design unico che ha portato l'azienda ad essere emblema della qualità made in Italy nel mondo.

A garanzia della progettazione ricercata ed accurata dell'azienda c'è la mente creativa di Giorgio Saporiti, maestro del design e della moda capace di reinterpretare le tendenze del momento in una chiave ironica e raffinata.

Nuovi prodotti dal design innovativo e con cromie ricercate saranno presentati per inserirsi perfettamente nella più ampia collezione esistente de Il Loft.

100% Italian design and exclusive materials form the leitmotifs of every single Il Loft project: fabrics, furniture, furnishings and interiors with clean, functional lines that never fail to amaze and kindle emotions. This unique approach to design has transformed Il Loft into an internationally recognised symbol of the best of "Made in Italy" quality.

Guaranteeing the company's sophisticated and meticulously crafted designs is the creative genius of Giorgio Saporiti, a past master at design and fashion who has a flair for interpreting the latest trends with refinement and a tasteful touch of humour.

The new innovatively designed products in refined tones will be unveiled and represent the perfect addition to Il Loft's wider existing collection.



Il Loft

Aspettatevi molto.

Abbiamo sempre affrontato le nuove sfide con energia e voglia di crescere

Da anni siamo diventati una comunità, una rete di clienti, rivenditori, appassionati al mondo del design, dell'arte e dell'innovazione.

Abbiamo quindi deciso di promuovere la nuova collezione in modo diverso, estendendo la nostra presenza oltre gli eventi fisici. Abbiamo elaborato contenuti editoriali che vi faranno scoprire i prodotti studiati e creati dall'architetto Giuseppe Viganò / Studio Viganò e da tutto il nostro team.

L'arte e il design possono essere un'ancora di salvezza per tutti noi, ci permettono di andare oltre con l'immaginazione, di proiettarci in luoghi innovativi, e di aprire nuove opportunità di dialogo e crescita.

Await the latest with high expectations.

We have always tackled new challenges head on with energy and a desire for growth

Years ago we became a community, a network of clients, retailers, and devotees of the world of design, art and innovation.

So we have decided to take a different approach to promote the new collection, taking our company beyond physical events. We have produced editorial content to help you discover and explore products designed and created by the architect Giuseppe Viganò / Studio Viganò and everyone on our team.

Art and design can be a lifeline for all of us; they enable us to go above and beyond with our imagination, project ourselves into innovative places, and unlock new opportunities for dialogue and growth.

Never Give Up

HOME 2020

Scopri la nuova collezione sul nostro sito illoft.com. Avrai inoltre la possibilità di scaricare i cataloghi di tutta la nostra collezione in formato digitale.

Explore the new collection on our website illoft.com, where you can also download digital versions of the catalogues featuring our entire collection.



Catalogo 2020
2020 Catalogue



Catalogo 25th Anniversary
25th Anniversary Catalogue

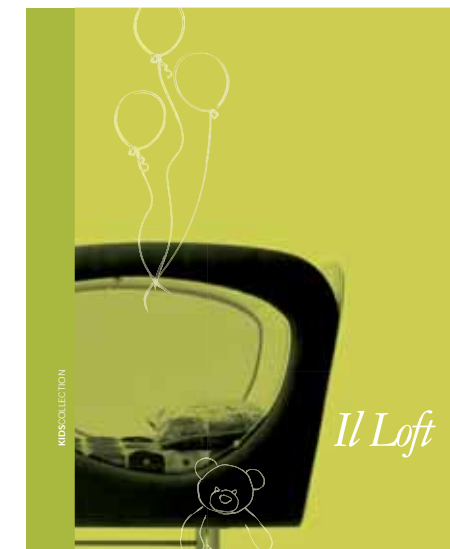

Catalogo Kids
Kids Catalogue



Catalogo Outdoor
Outdoor Catalogue

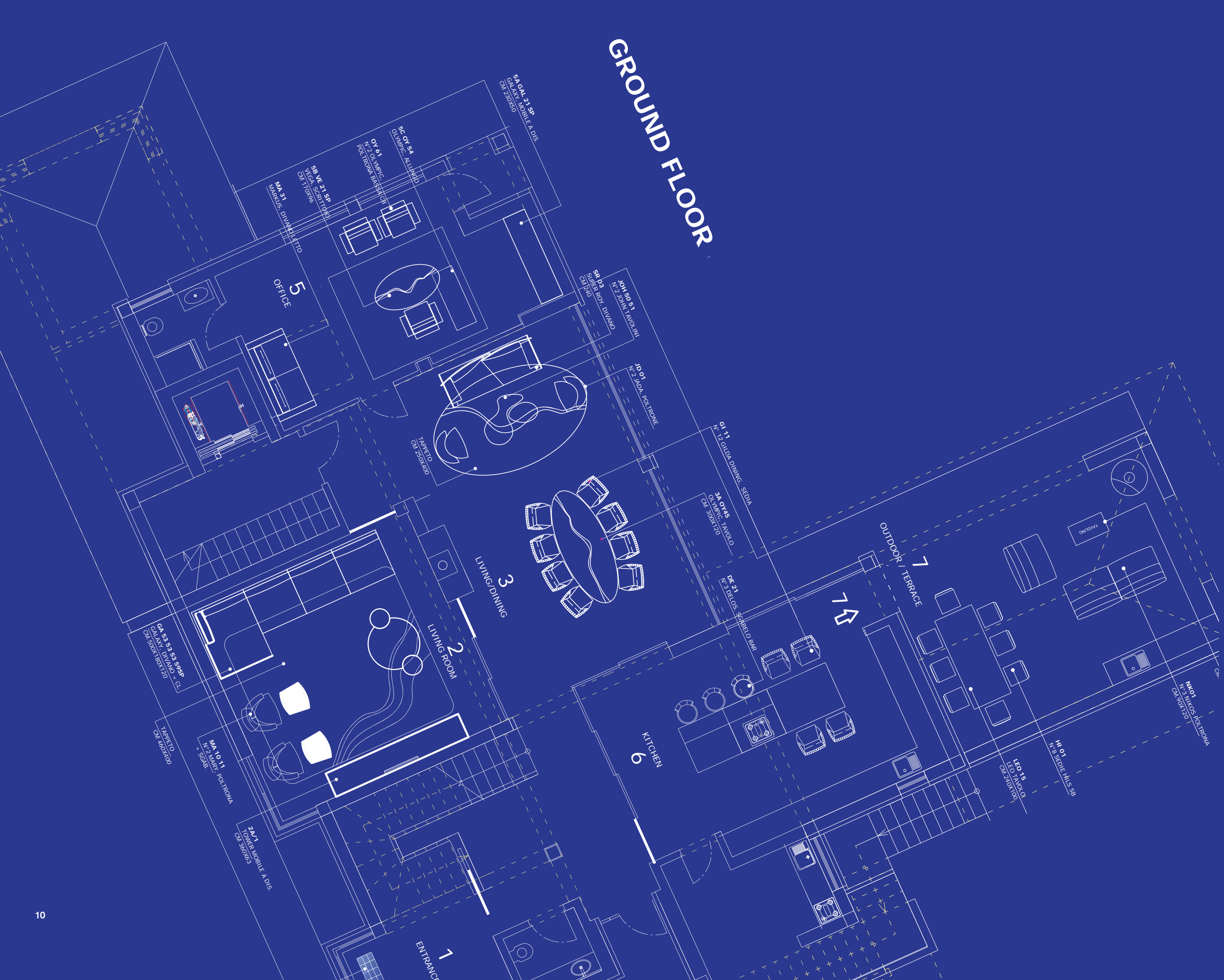

GROUND FLOOR

LIVING

Antelope	14
Giorgio	54
Airstrike	58
Freespirit Curvo	74
Freespirit	102
Moonstar	118
Ikon	140

DINING

Tracer	160
Vancouver	168
Vega	176
Leo	184
Airstrike	188
Stallior	196

BEDROOM

Ikon	206
Freespirit	212
Nightside	218

LIVING

Antelope	14
Giorgio	54
Airstrike	58
Freespirit Curvo	74
Freespirit	102
Moonstar	118
Ikon	140

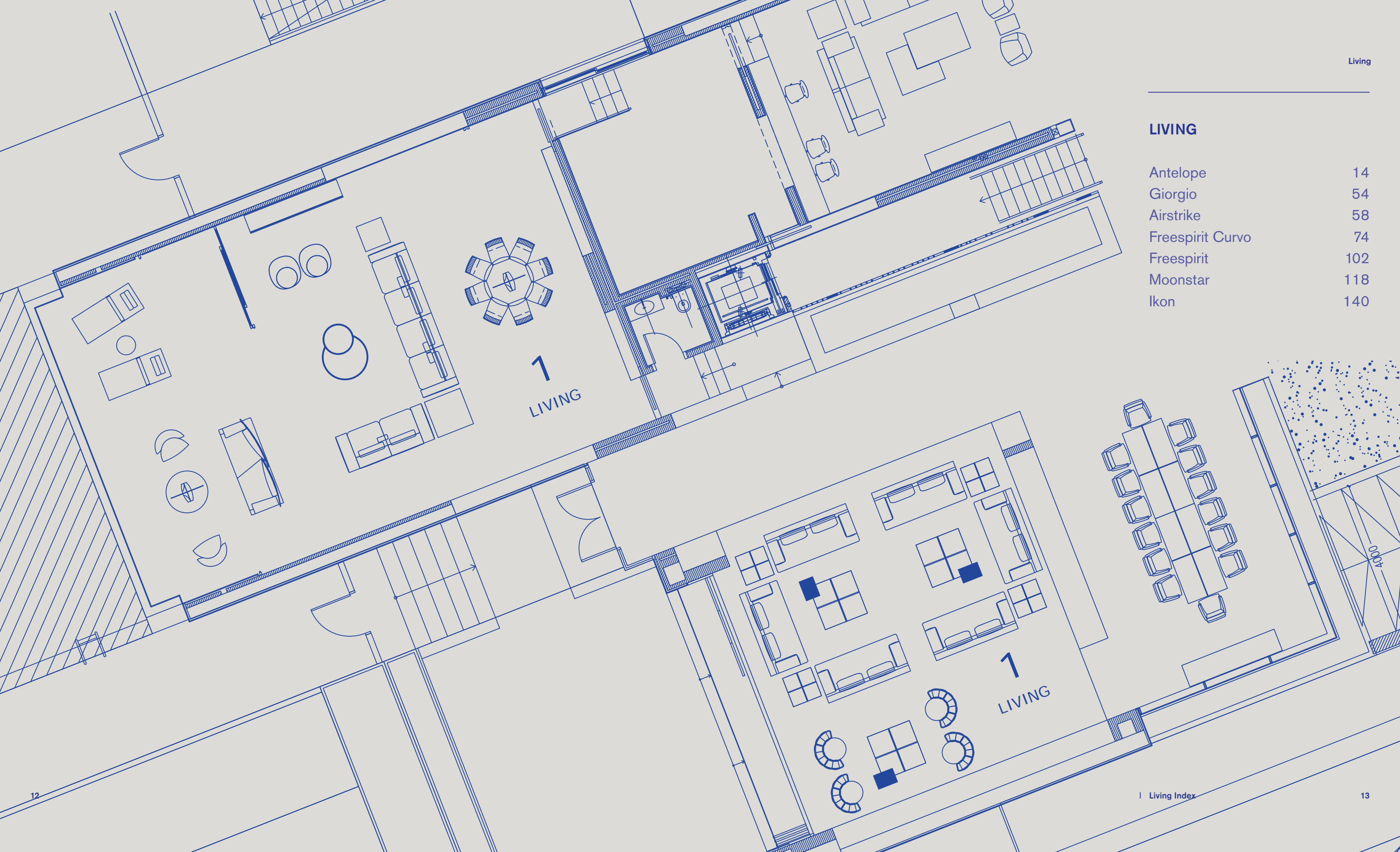



Living

Antelope

Antelope

Arch. Giuseppe Viganò – Studio Viganò



L'idea del divano Antelope nasce dall'Antelope Canyon formatosi migliaia di anni fa grazie all'erosione della pietra arenaria ad opera di vento ed acqua.

Proprio come il Canyon, il divano sembra scavato da un pezzo intero, come fosse stato modellato dal vento col passare del tempo. Questa "erosione" del divano avviene ovunque, sia all'esterno creando un grandissimo dinamismo, sia sulla seduta formando diverse profondità di seduta per vivere il divano in modo differente.

The idea for the Antelope sofa was inspired by Antelope Canyon, which was formed by the wind and rain eroding the sandstone thousands of years ago.

Just like Antelope Canyon, the sofa seems to have been carved from one solid piece, as if it had been crafted by the wind through the centuries. This "erosion" can be seen all over the sofa, creating breath-taking dynamism on the exterior, and across the seating where it forms a variety of seating depths enabling the sofa to be enjoyed in many different ways.

Il Loft





















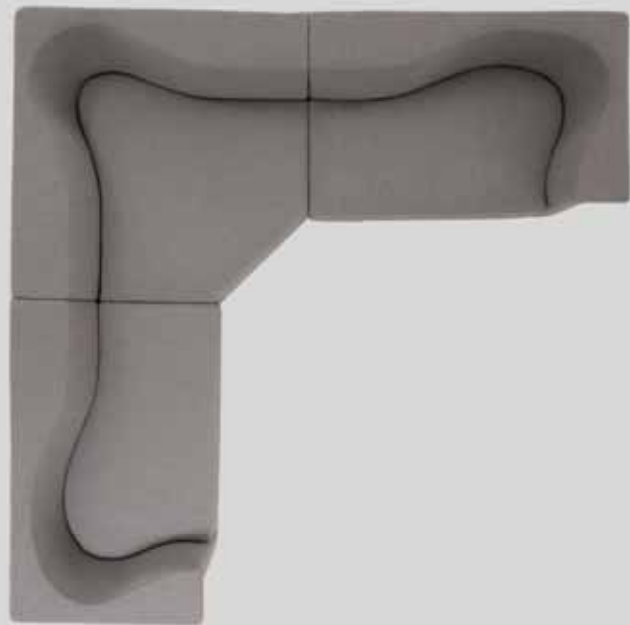
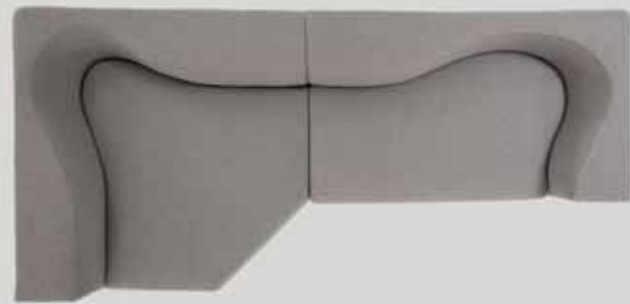



















Giorgio

Arch. Giuseppe Viganò - Studio Viganò

Poltrona dal grande impatto visivo, dove le linee curve e sottili ne caratterizzano la forma.

Una struttura ultralight che accoglie il corpo accompagnandolo nel relax e dandogli quasi la sensazione di fluttuare.

Un design unico e moderno, un complemento d'arredo raffinato ma con una grandissima personalità.

A strikingly eye-catching armchair distinctively shaped by subtle, curved lines.

An ultralight structure welcomes the body and encourages relaxation, almost making you feel as if you are floating.

A unique, modern design for refined furnishing with immense personality.





Airstrike

Arch. Giuseppe Viganò - Studio Viganò

AIRSTRIKE nasce da un segno che diventa forma, come un nastro che si annoda.

Una collezione a tutto tondo: da un bracciolo dalla forma ovalizzata prende vita lo schienale. Linee morbide e accattivanti, accoglienti e confortevoli regalano un'immagine molto soffice e creativa.

L'imponenza dell'imbottitura si armonizza con la leggerezza della base metallica che impreziosisce il progetto.

Della collezione fanno parte il divano, il pouf, la poltrona, sia nella versione fissa che con basamento girevole, la sedia e lo sgabello.

AIRSTRIKE is inspired by a symbol taking shape, like a knot in a ribbon.

A well-rounded collection: an oval-shaped armrest forms the genesis for the backrest. The soft, eye-catching lines are welcoming and comfortable with an incredibly cosy yet creative look.

The grandeur of the padding is a perfect match for the lightness of the metal base that embellishes the entire project.

The collection includes a sofa, pouffe, chair, stool, and an armchair designed with a swivel or fixed base.













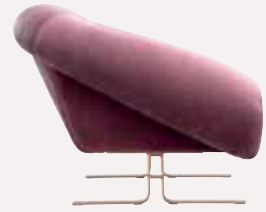



Freespirit Curvo

Arch. Giuseppe Viganò - Studio Viganò

Divano dallo spirito libero definito da una vaschetta in metallo rivestito che diventa fianco e schienale ed accoglie morbidi e sformati cuscini.

Ha due anime che lo rappresentano: una più lineare che disegna composizioni in linea, e una più sinuosa che permette composizioni curvilinee che si espandono nello spazio caratterizzando fortemente gli ambienti.

A free-spirited sofa defined by an upholstered metal tray that forms the sides and back and envelops soft, misshapen cushions.

A free spirit with a dual soul: the more linear version is perfect for straight-line compositions, while the more sinuous design creates curvilinear compositions that grow into the space, ensuring a style statement in any interior.













Freespirit Curvo

Arch. Giuseppe Viganò - Studio Viganò



















Freespirit

Arch. Giuseppe Viganò - Studio Viganò

















Moonstar

Arch. Giuseppe Viganò - Studio Viganò

Divano dallo schienale alto estremamente confortevole composto da una scocca in metallo che abbraccia fianchi, schiena e base del divano.

Uno speciale piede dalla forma ovalizzata lo solleva e alleggerisce. L'anima di questo divano è fashion caratterizzata da cuscini dalle diverse texture, disegni e cuciture con inserimenti di altri materiali. Speciali decori sono stati appositamente studiati per dare risalto ed enfatizzare ogni singolo cuscino.

This sofa features an extraordinarily comfortable high backrest created by a metal frame that encompasses the sides, back and base of the sofa.

A special oval-shaped foot raises the sofa, giving it a lighter appearance. This fashion-led sofa features cushions in different textures, designs and seams with inserts made from other materials. Custom designed special embellishments showcase and emphasise each and every cushion.









Living

Moonstar





Living

Moonstar





Moonstar

Arch. Giuseppe Viganò - Studio Viganò

Il Loft









Ikon

Arch. Giuseppe Viganò – Studio Viganò

La COLLEZIONE IKON è definita da divano e poltrona. Il DIVANO IKON dalle forme squadrate ed eleganti è caratterizzato da una speciale struttura interna formata da molle per dare confort a seduta e schienale, sollevato da terra con dei piedi in metallo.

The IKON COLLECTION features a sofa and armchair. Designed with elegant, square shapes, the IKON SOFA has a special internal structure with springs to ensure the seating and backrest are even more comfortable. The sofa is raised from the floor with metal feet.

Il Loft







Living

Ikon











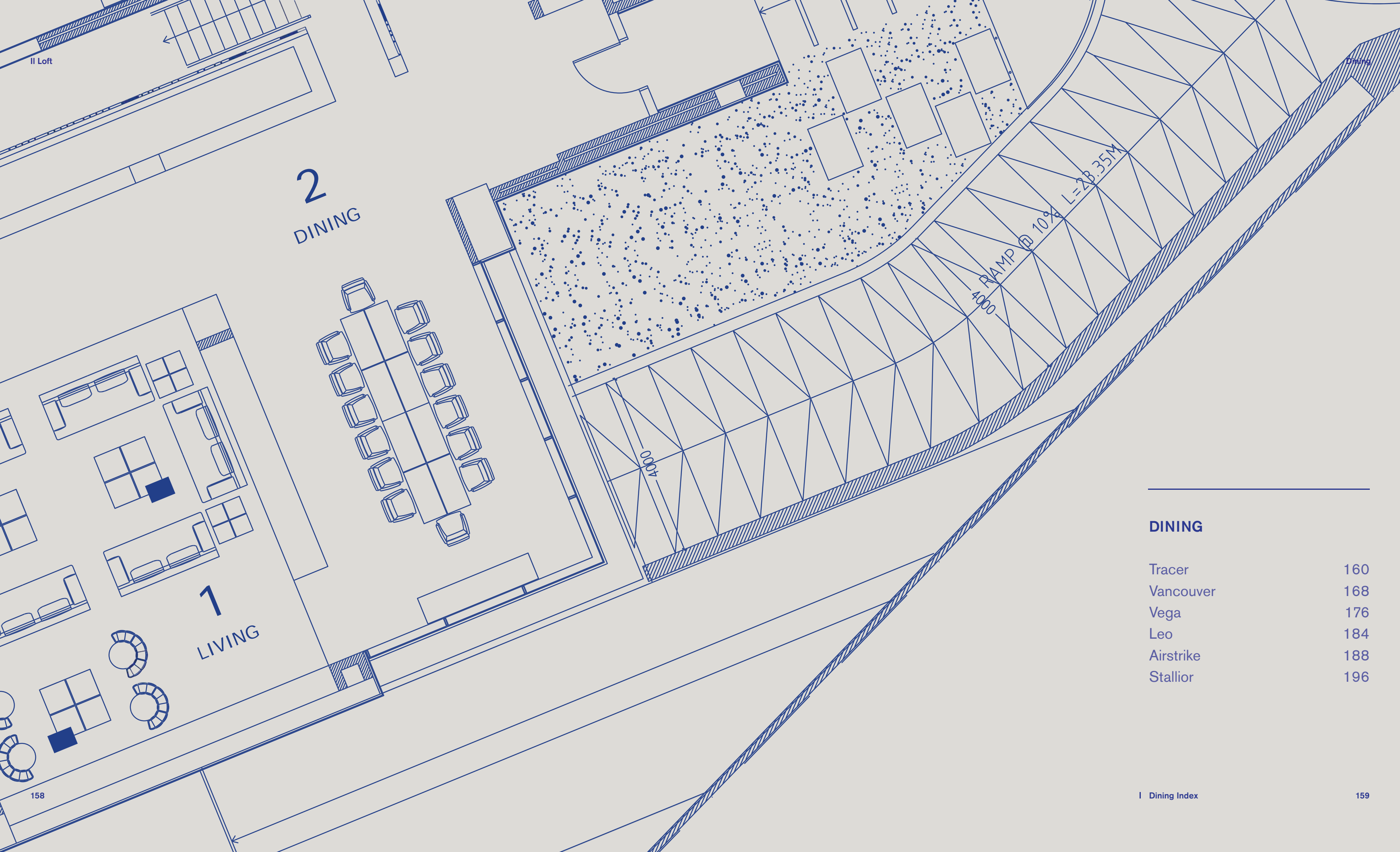

Il Loft

Dining

2
DINING

1
LIVING

RAMP @ 10% L=28.35M
4000

4000

DINING

Tracer	160
Vancouver	168
Vega	176
Leo	184
Airstrike	188
Stallior	196



Dining

Tracer



Tracer

Arch. Giuseppe Viganò - Studio Viganò

La collezione di tavolo e tavolini sono il risultato di un design dalla forte personalità. Stupisce per l'utilizzo dei materiali che creano prodotti unici e perfetti per ogni tipologia di ambiente.

La forma pulita e imponente del basamento è caratterizzata dall'uso della lamiera metallica che lo rende leggero ed estremamente innovativo. Non solo la base ma anche il piano è studiato in ogni dettaglio, una forma nuova e svasata che viene enfatizzata grazie all'uso della laccatura che può essere abbinata alla base.

The Tracer collection of a table and low tables is designed with a powerful personality. The way materials have been chosen to create unique products is amazing and they are perfect for all styles of interior design.

The hallmark feature of the clean, imposing shape of the base is sheet metal, which ensures an extremely innovative lightweight look. Like the base, every detail of the top has also been carefully designed to create a new, flared shape which is showcased by the use of lacquer that can be selected to match the base.







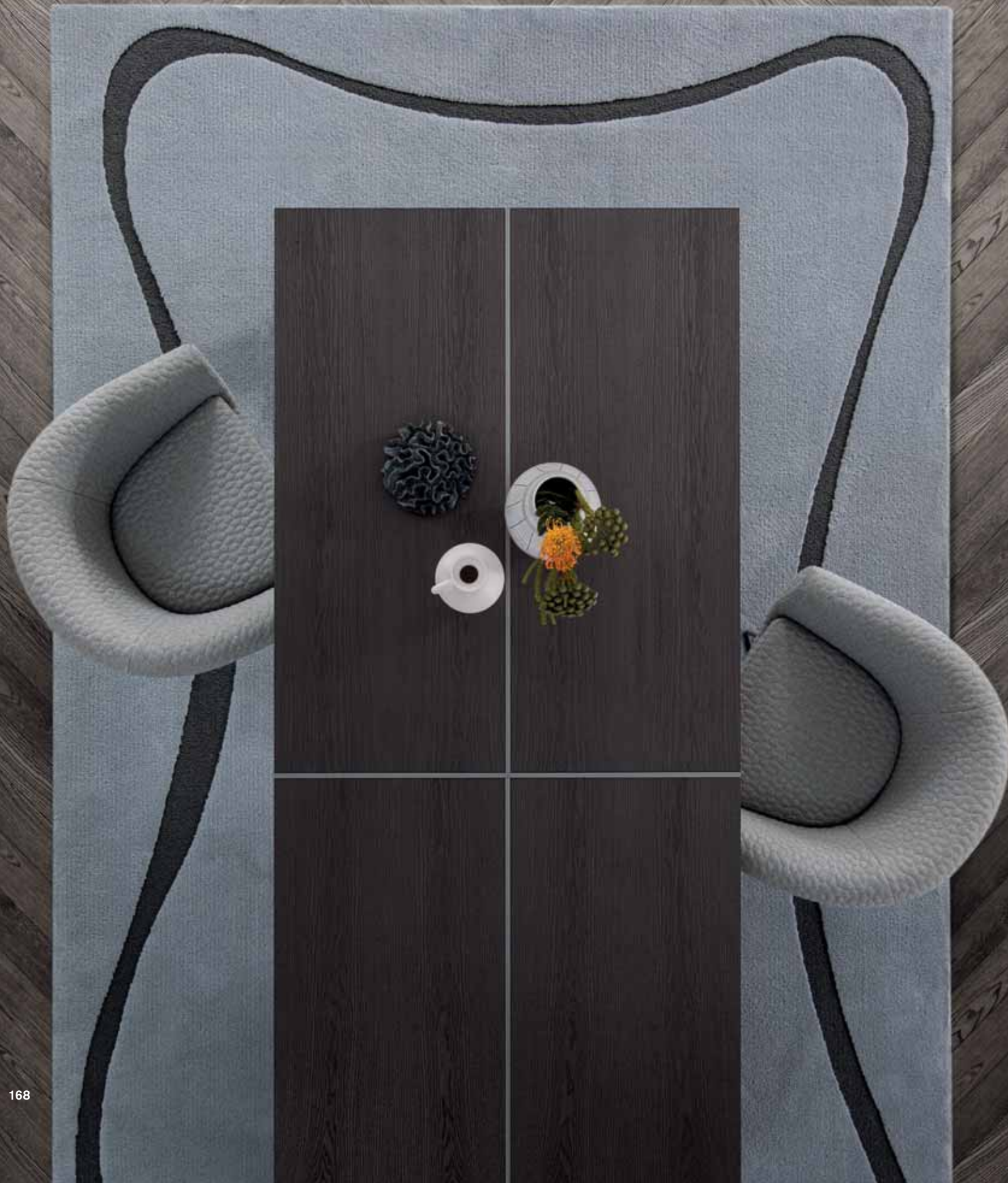

Vancouver

Giorgio Saporiti

Tavolo in legno con inserimento centrale di un profilo di acciaio satinato realizzato nelle finiture della nostra collezione.

Serie di mobili con piano a doppio spessore e spalle portanti. All'interno vengono posizionati dei contenitori ad ante o cassetti che appoggiano su barre metalliche cilindriche.

This wooden table has a central insert featuring a satin steel profile created with finishes from our collection.

Series of units with double layer tops and supporting sides. Internal modules with doors or drawers and supported by cylindrical chromed steel bars.

Il Loft









Dining

Vega



Vega

Giorgio Saporiti

Serie di tavolini, tavoli, scrittoi e mobili con top in legno con inserto di metallo tagliato a laser e base in metallo.

A collection of low tables, tables, desks and furniture featuring a wooden top with a laser-cut metal insert, and a metal base.

Il Loft







Leo

Giorgio Saporiti

Serie di tavoli con base in metallo verniciato con top in vetro marmo.

A collection of tables featuring a lacquered metal base and marble glass top.







Dining

Airstrike



Airstrike

Arch. Giuseppe Viganò - Studio Viganò



Il Loft







Dining

Airstrike



Stallior

Arch. Giuseppe Viganò – Studio Viganò

Collezione mobili Stallior. Due volumi di due diversi materiali (vetro bronzato e legno con intarsi geometrici) che si incastrano l'uno dentro l'altro e generano la MADIA STALLIOR.

Della stessa famiglia anche il MOBILE SOGGIORNO STALLIOR dove i due volumi, un vano a giorno di vetro e il contenitore in legno intarsiato, sono separati da uno spazio su pedana appositamente pensato per alloggiare sculture, vasi, opere d'arte.

Completa la collezione il MOBILE BAR STALLIOR composto da diversi volumi di differenti materiali.

The stallior furniture collection. Two pieces each in two materials (bronze glass and wood with geometric inlays) are set into each other to create the STALLIOR SIDEBOARD.

The collection also features the STALLIOR LOUNGE UNIT in which an open glass shelf and inlaid wooden container are separated on a plinth by a space specially designed to display sculptures, vases and works of art.

Rounding off the collection is the STALLIOR BAR made from two different parts in different materials.

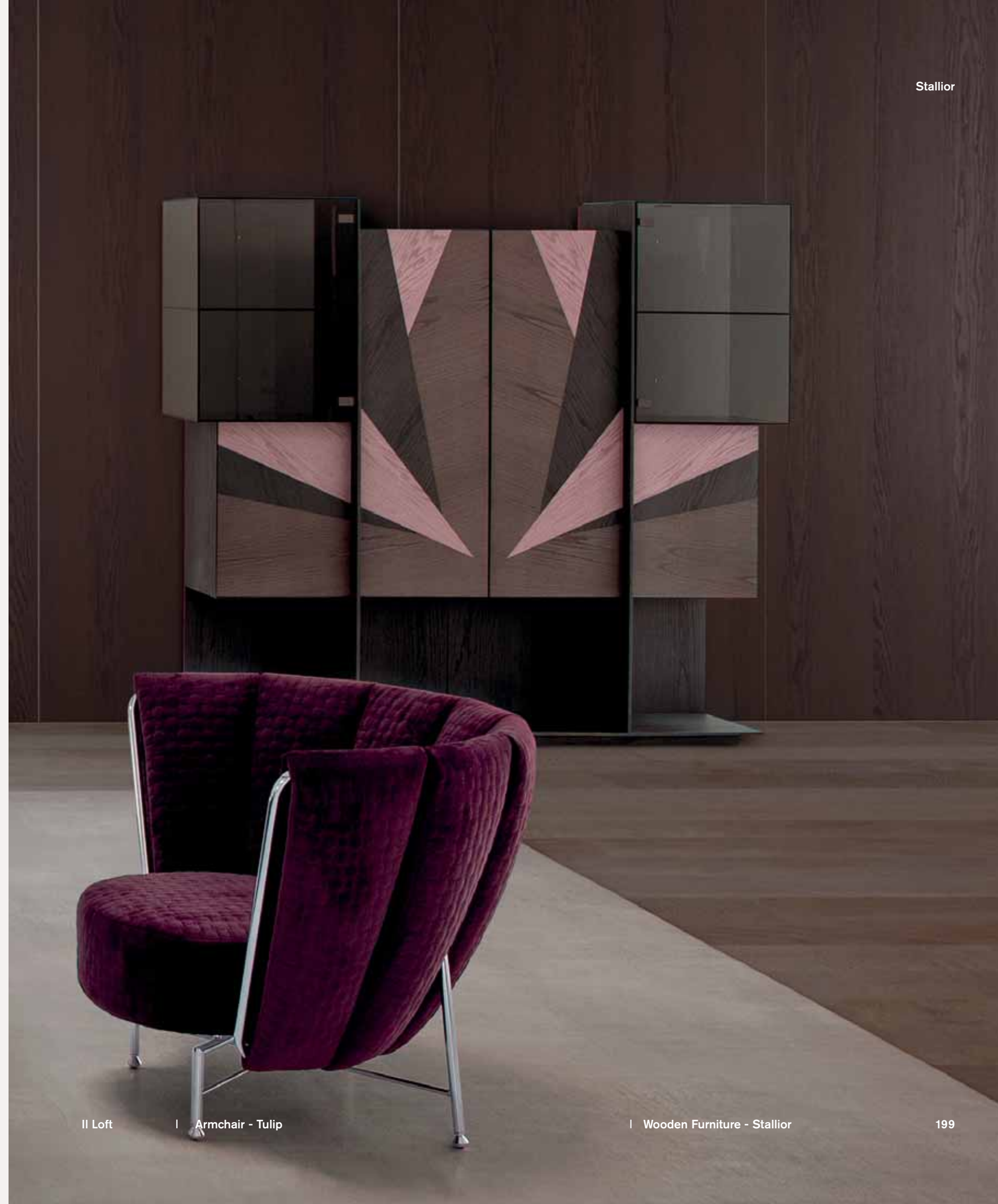





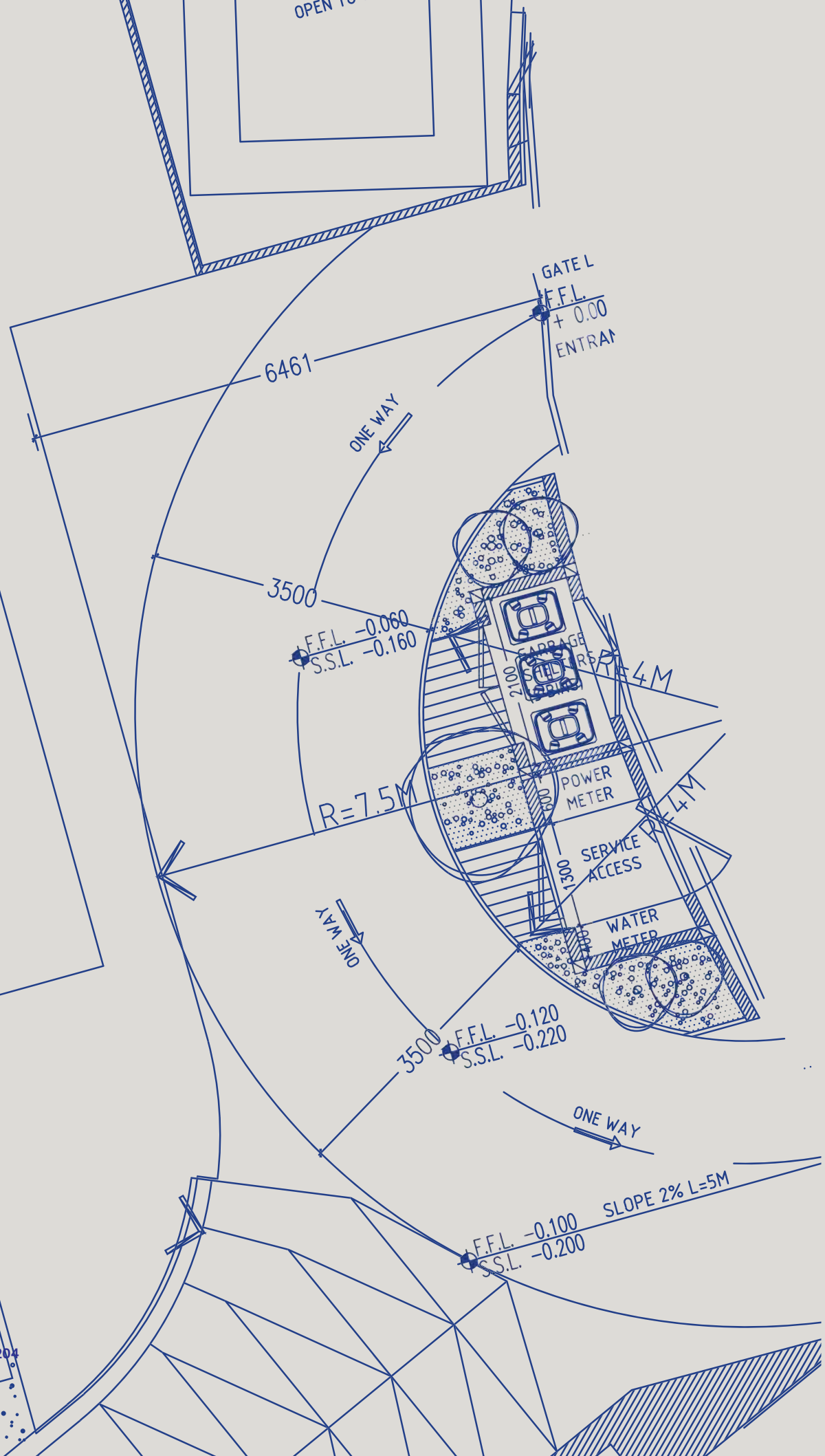
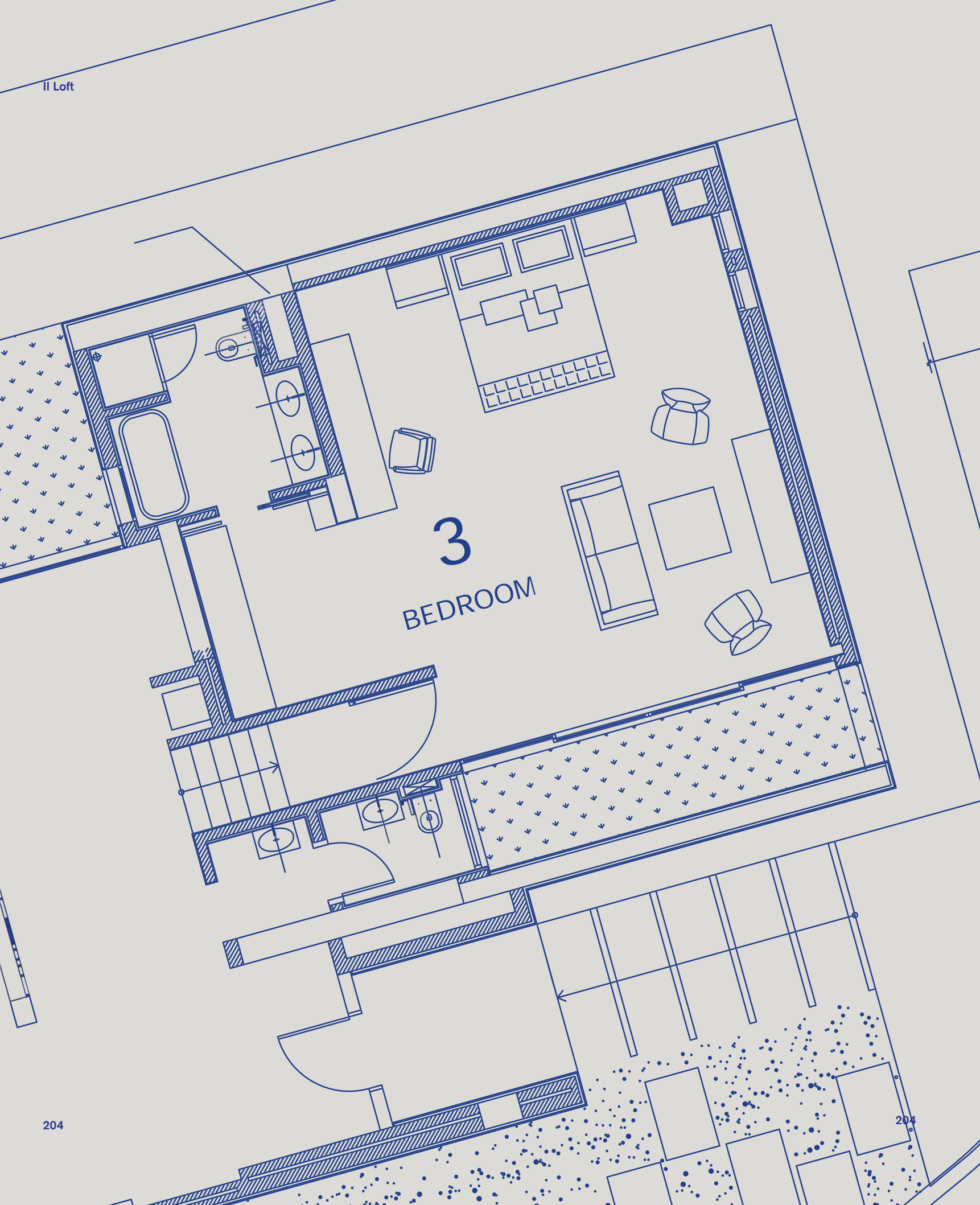

BEDROOM

Ikon	206
Freespirit	212
Nightside	218



Ikon

Arch. Giuseppe Viganò - Studio Viganò

Come il divano, il letto IKON ha forme squadrate ed eleganti ed è sollevato da terra con dei piedi in metallo. Una morbida e alta testata gli dona un look importante e confortevole nonostante la rigidità delle linee.

Like the sofa, the IKON bed is designed with elegant, square shapes and raised from the floor with metal feet. A soft, high headboard gives the bed a magnificent, comfortable look despite the precision lines.







Freespirit

Arch. Giuseppe Viganò - Studio Viganò

Letto dallo spirito libero definito da una vaschetta in metallo rivestito che contiene il materasso e la testata.

Quest'ultima è caratterizzata da due cuscini dalle forme soffici e sinuose.

A free-spirited bed defined by an upholstered metal tray containing the mattress and headboard.

The headboard features two cushions designed with soft, sinuous shapes.







Nightside

Arch. Giuseppe Viganò - Studio Viganò

Letto giovane e fresco che esce dagli schemi convenzionali e rigorosi.

La forma svasata del giroletto dona originalità al letto insieme alla forma irregolare della testata che regala movimento e un gran senso di confort.

A cool, young bed that breaks with convention and strict design rules.

The flared shape of the bed base gives the bed an original look as does the uneven shape of the headboard, which adds a sense of movement and immense feeling of comfort.







Ciao Capo!

Grazie per tutto quello che hai fatto per me e per i tuoi preziosi insegnamenti che non dimenticherò mai.

Mi hai trasmesso la passione per la fotografia quando ero ancora piccolo, dicendomi semplicemente: "Vai e fotografa" dandomi la tua Hasselblad.

Sarai sempre nel mio cuore.

Adesso sei libero di colorare il Paradiso così come hai sempre colorato il Mondo.

Thank you for all you did for me and for your invaluable teachings, which I will never forget.

You enthused me with your passion for photography when I was still a young boy, by handing me your Hasselblad and simply saying: "Go and take pictures."

You will always be in heart.

Now you are free to fill Heaven with colour just as you always coloured everything down here on Earth.



Giorgino



Credits

La Fabbrica d'Autore Carlo Moretti viene fondata nel 1958 dai fratelli Carlo e Giovanni Moretti, insieme impegnati in una costante ricerca di innovazione del design contemporaneo di una delle più rinomate arti: l'arte del vetro di Murano.

Uno stile inconfondibile veste oggetti dalle linee pulite ed essenziali, resi unici da un'elevata maestria e professionalità che non dimentica inoltre la responsabilità del rispetto della Laguna di Venezia grazie a comportamenti sostenibili verso l'ambiente.

Carlo Moretti is a "factory of originals" founded in 1958 by Carlo and Giovanni Moretti, combining innovation and continuous research.

Unique pieces, numbered and signed with their recognizable style, in a stylistic key in constant research for new, clean and essential lines, with the support of the technical innovation.

AD
Carlo Magnoli

Graphic Design
MMG

Photo
Giorgio Saporiti jr

Styling
Conti Marchetti

Printed in Italy by
AGF S.p.A.

I colori dei tessuti, delle pelli e dei legni delle nostre realizzazioni fotografate su questo catalogo possono non essere perfettamente riprodotti in stampa.

The reproduction of the colours of our fabrics, leathers and woods photographed in this catalogue may vary slightly from the original shade due to printing.

June 2020

Il Loft

Antelope

Giuseppe Viganò / Studio Viganò

| Sofa

|

Antelope

Giuseppe Viganò / Studio Viganò

| Sofa

| 3 |

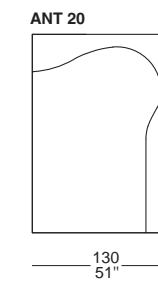
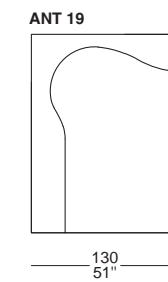
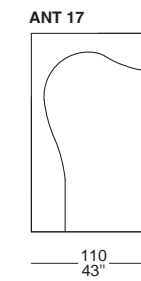
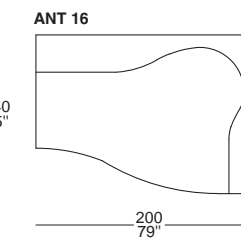
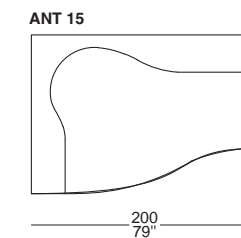
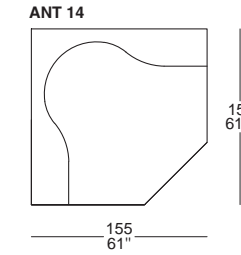
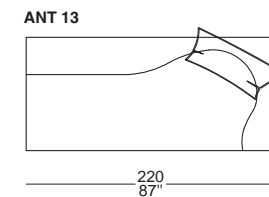
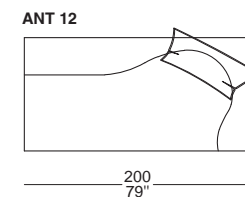
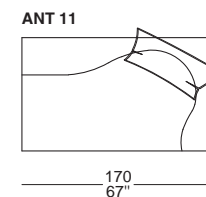
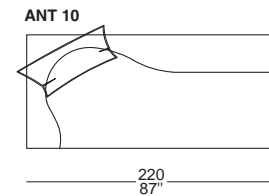
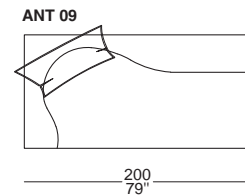
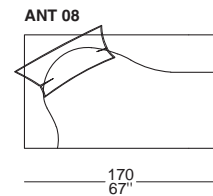
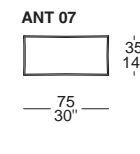
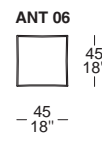
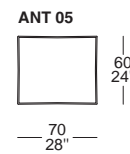
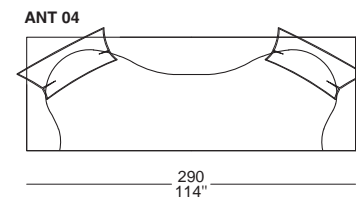
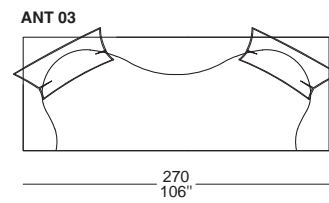
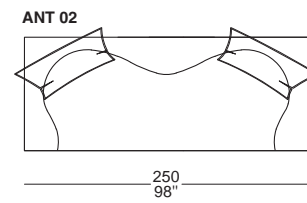
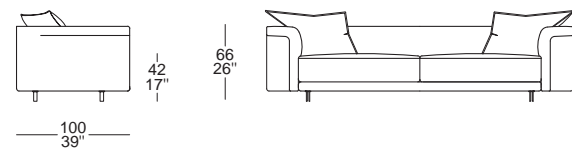
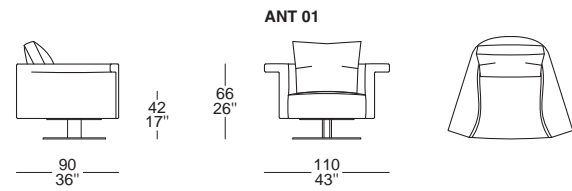

Antelope
Giuseppe Viganò / Studio Viganò

| Sofa

|

Antelope
Giuseppe Viganò / Studio Viganò

| Sofa

5 |

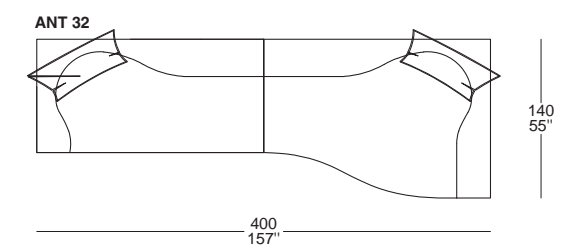
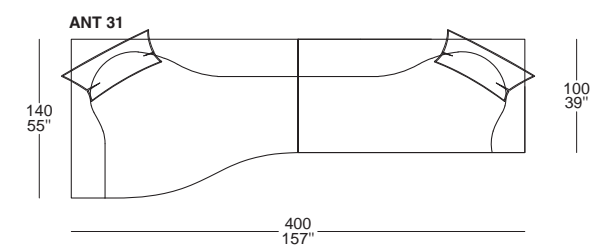
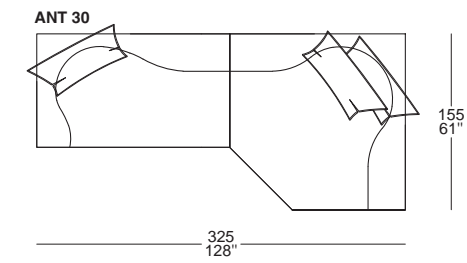
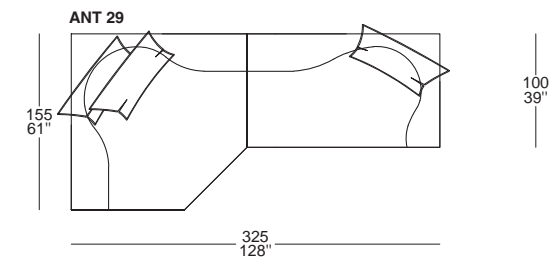
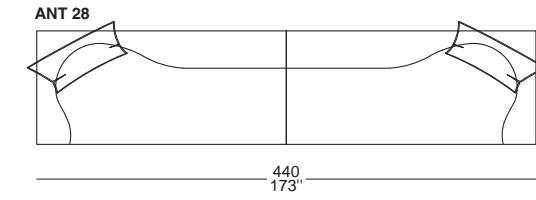
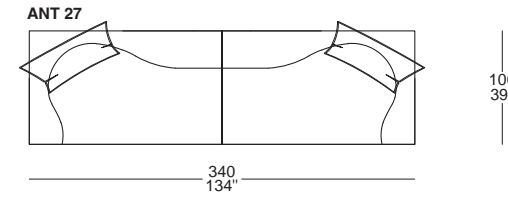
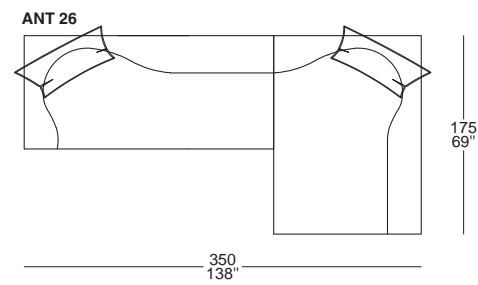
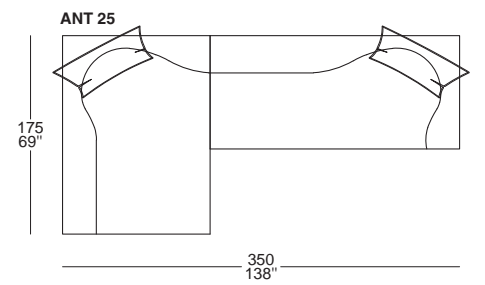
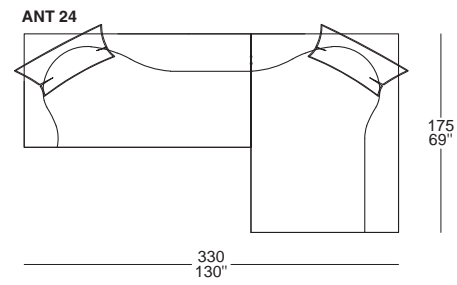
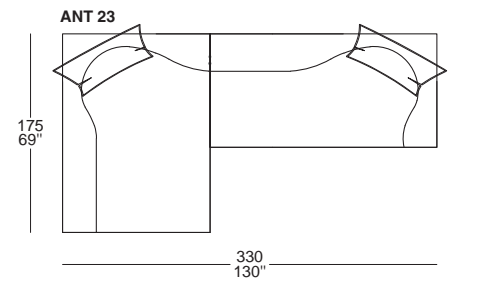
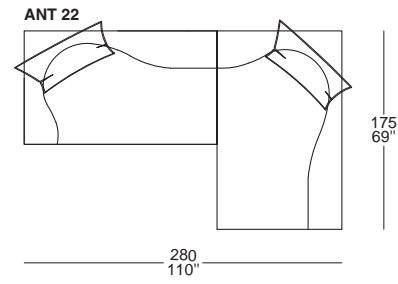
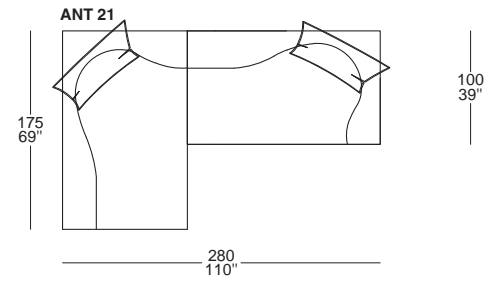

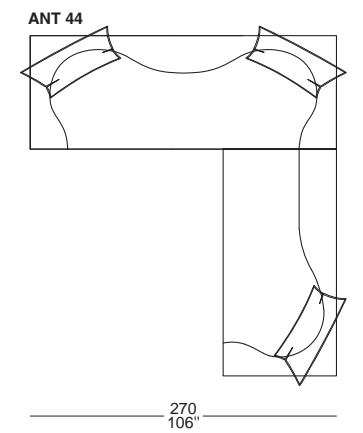
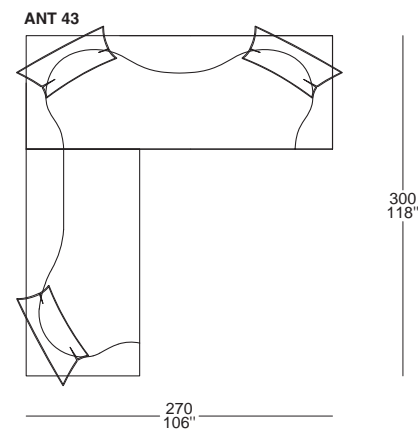
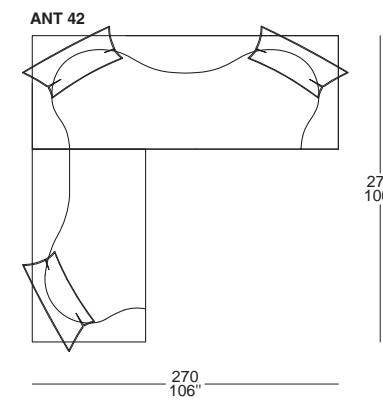
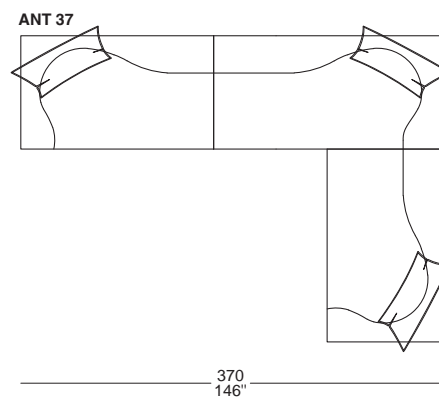
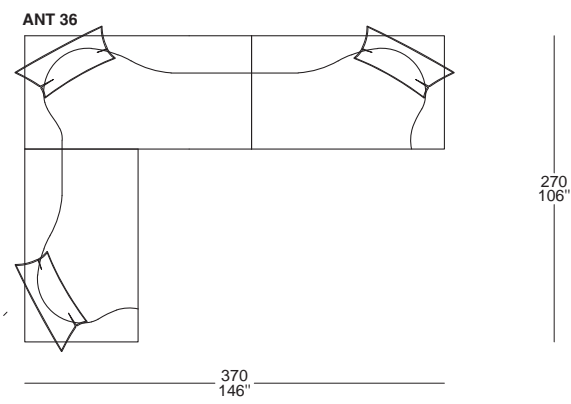
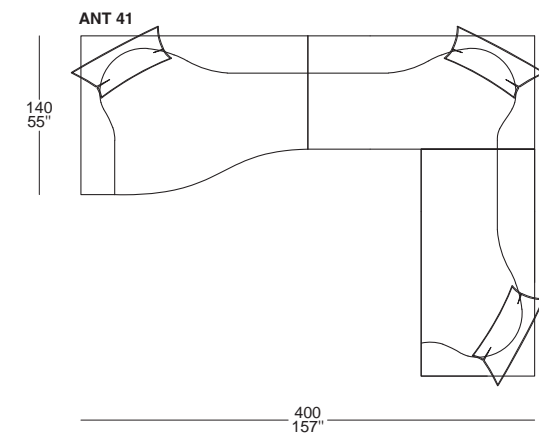
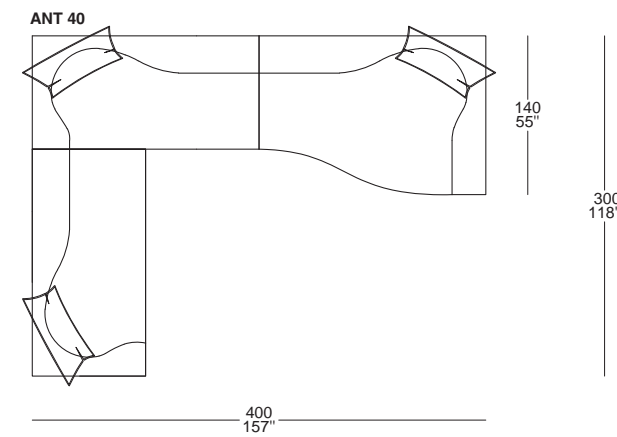
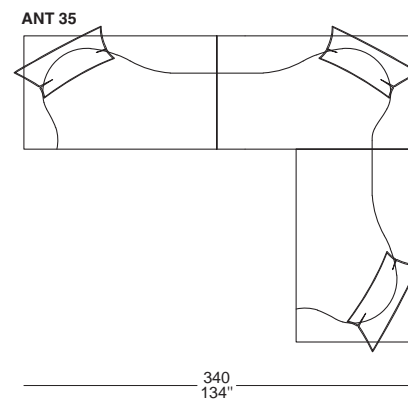
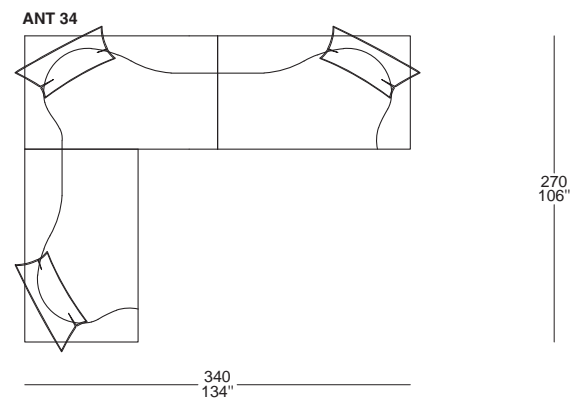
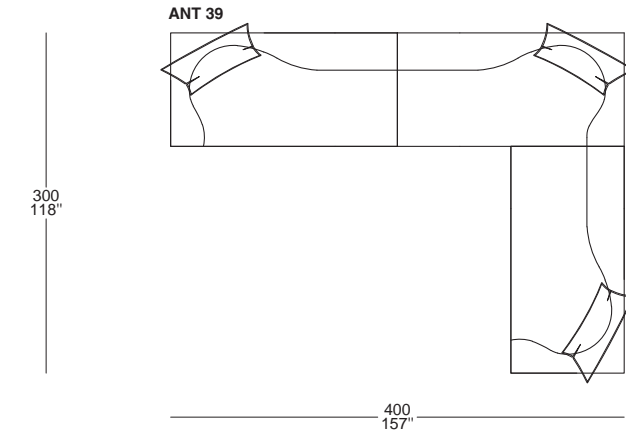
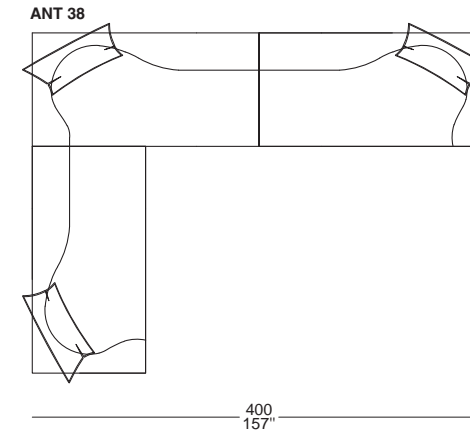
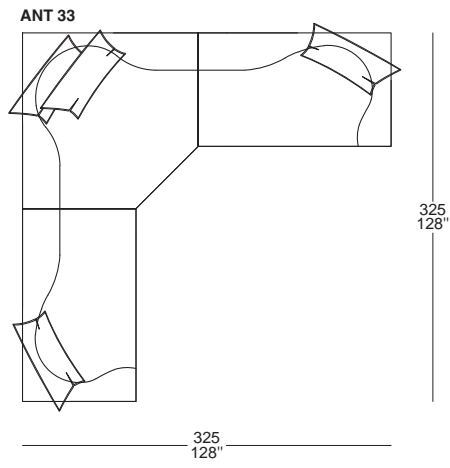

Airstrike

Giuseppe Viganò / Studio Viganò

| Sofa

|

Airstrike

Giuseppe Viganò / Studio Viganò

| Sofa

9 |

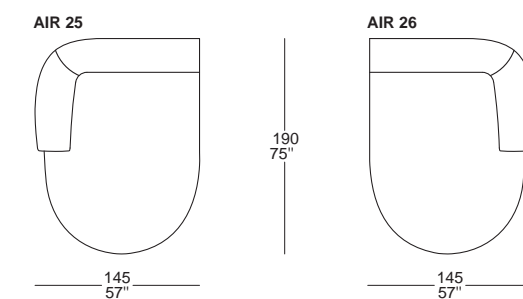
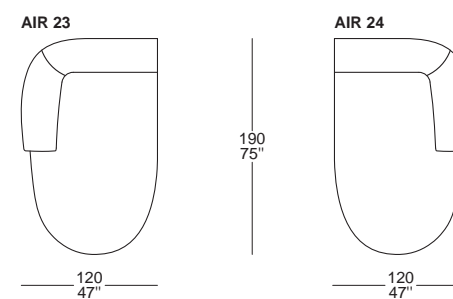
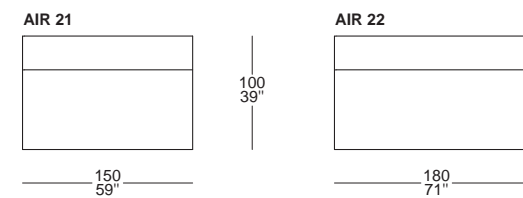
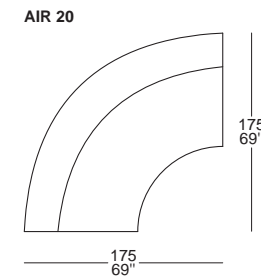
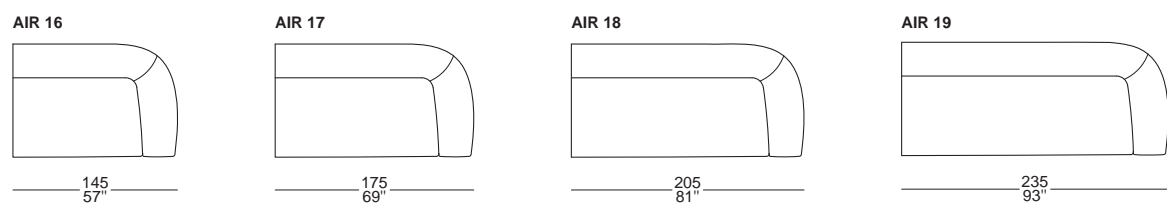
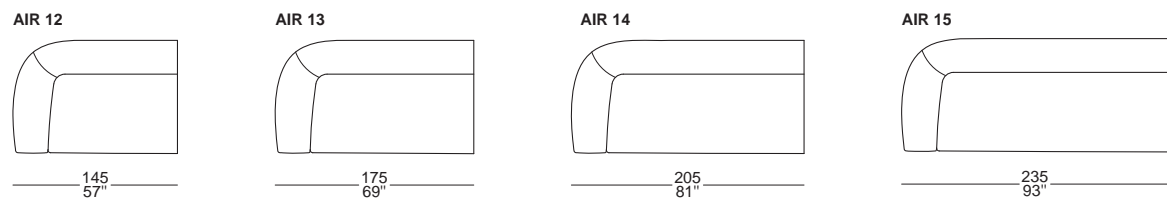
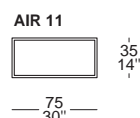
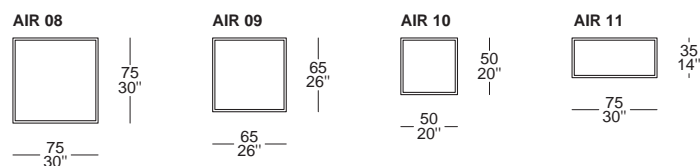
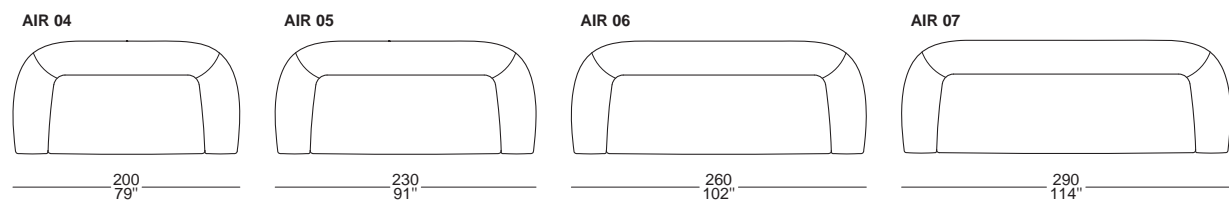
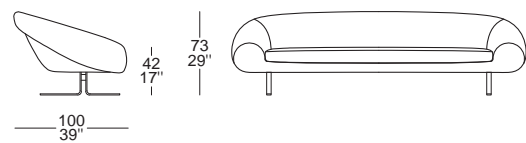
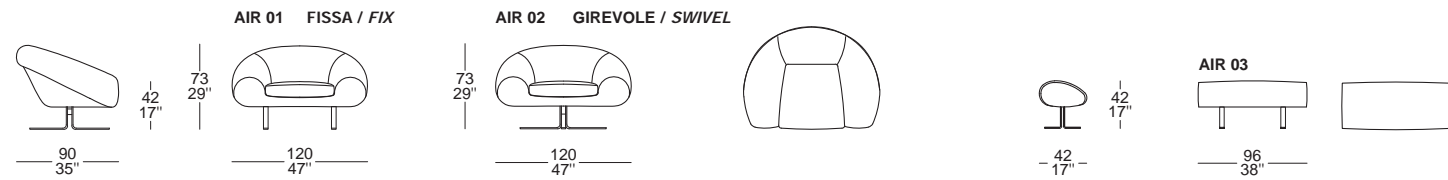

Airstrike

Giuseppe Viganò / Studio Viganò

| Sofa

|

Airstrike

Giuseppe Viganò / Studio Viganò

| Sofa

| 11

AIR 27

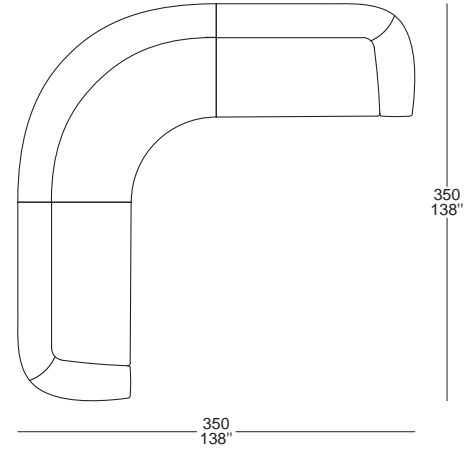

AIR 28

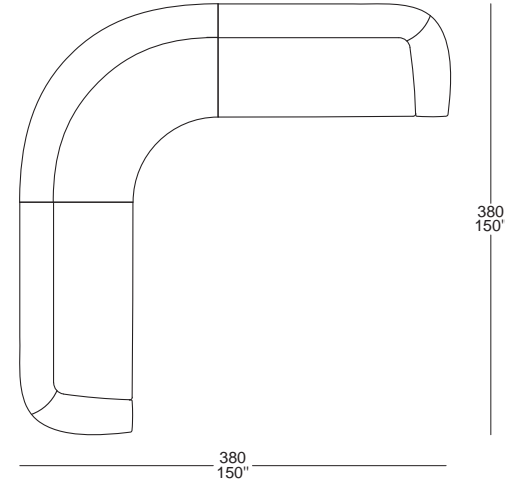

AIR 35

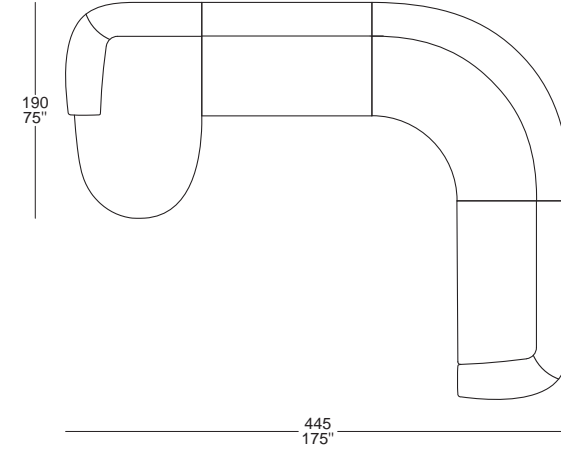

AIR 36

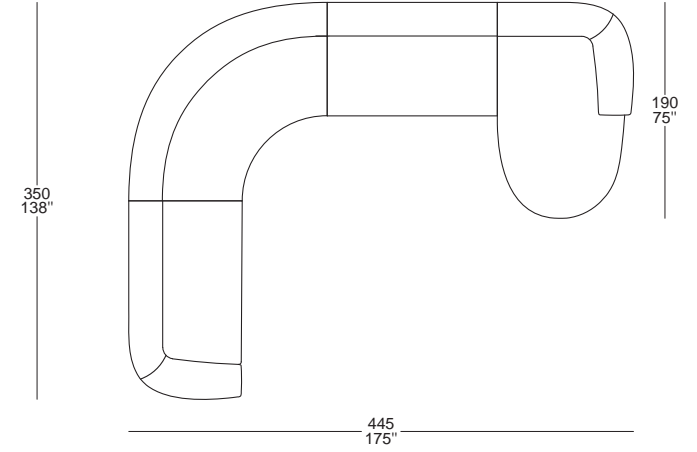

AIR 29

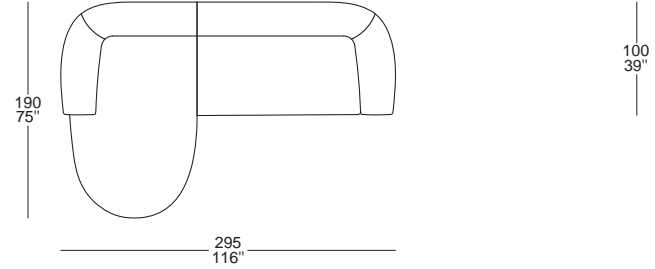

AIR 30

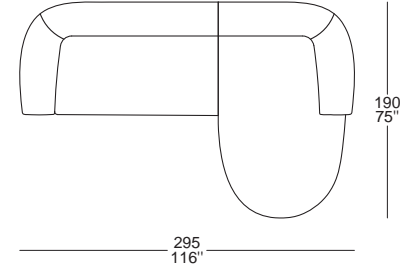

AIR 37

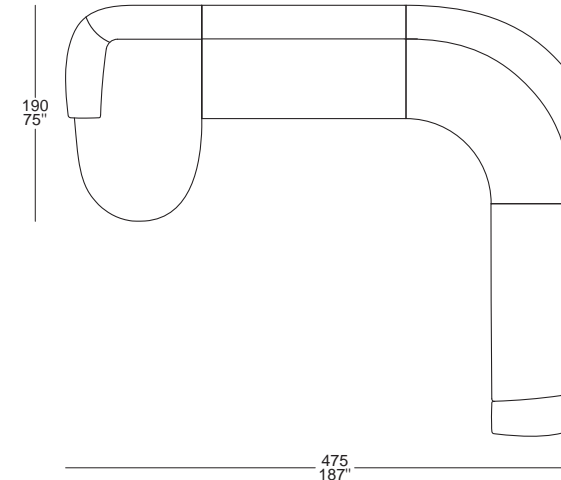

AIR 38

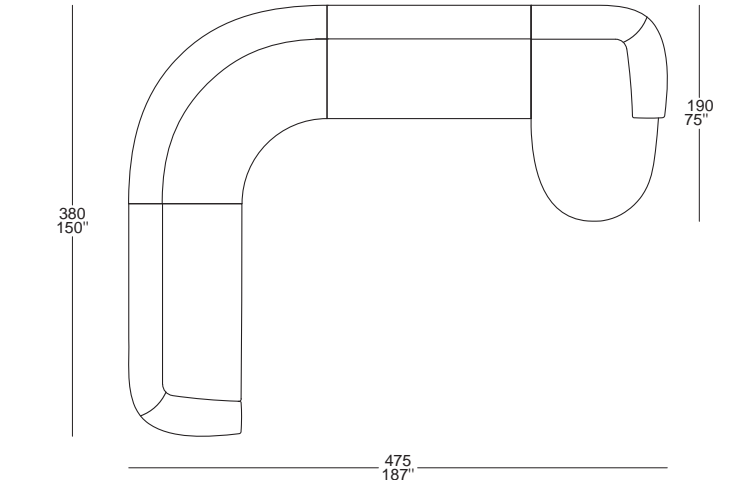

AIR 31

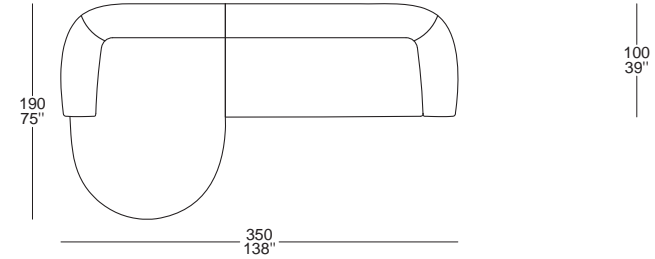

AIR 32

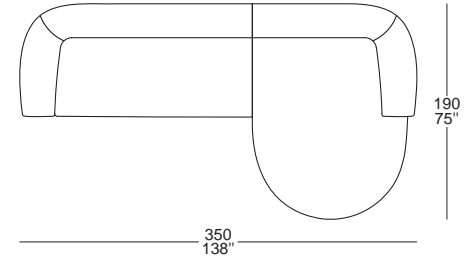

AIR 33

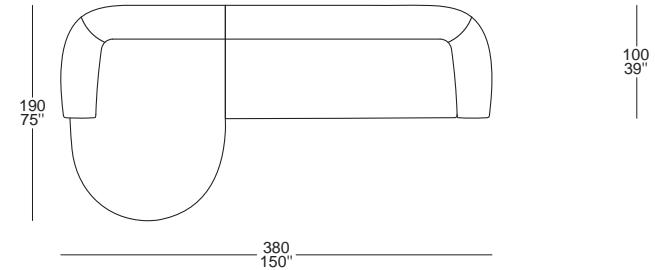

AIR 34

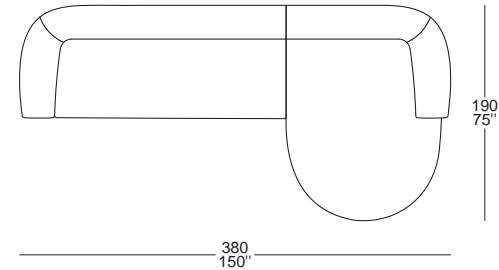

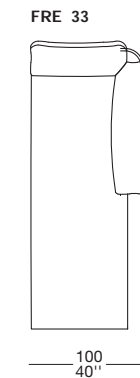
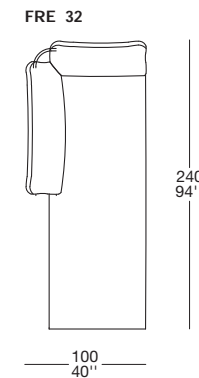
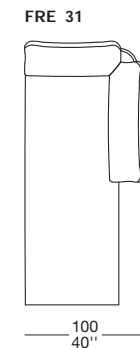
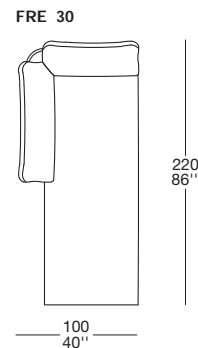
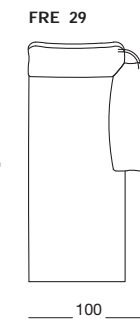
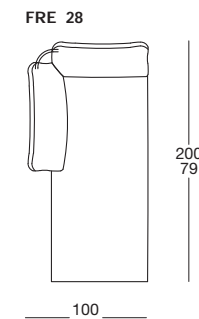
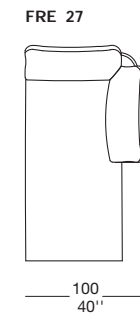
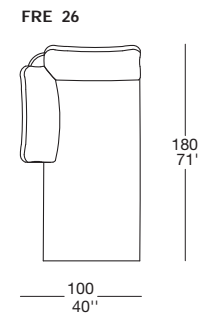
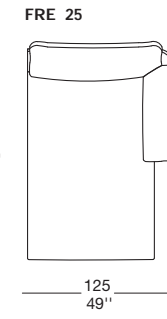
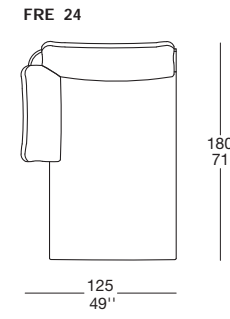
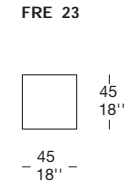
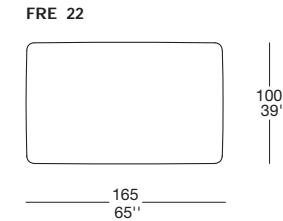
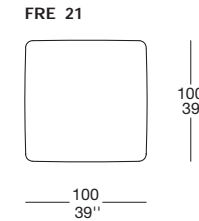
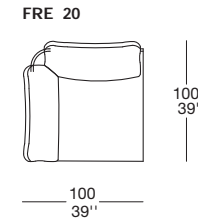
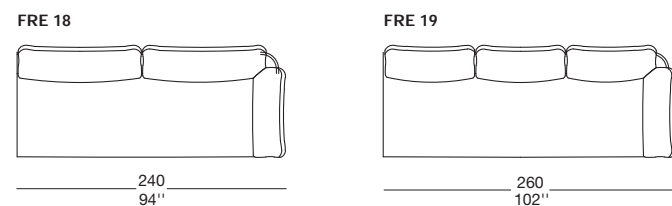
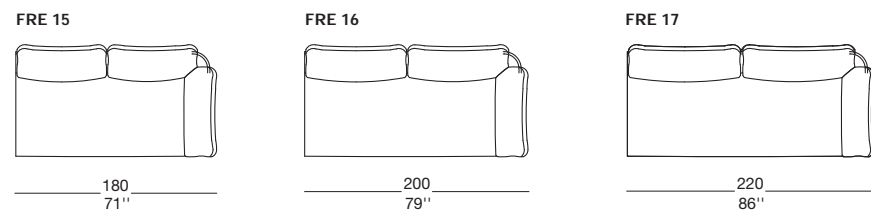
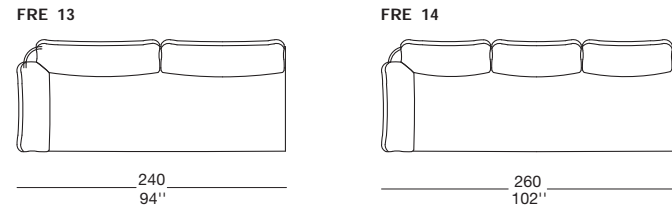
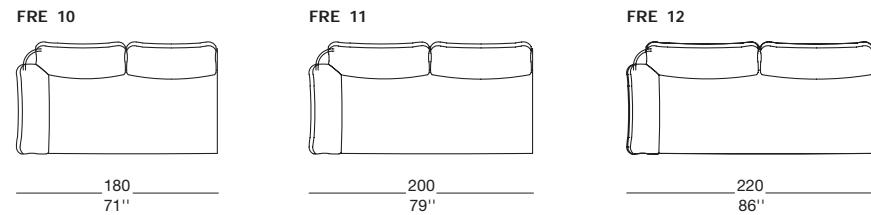
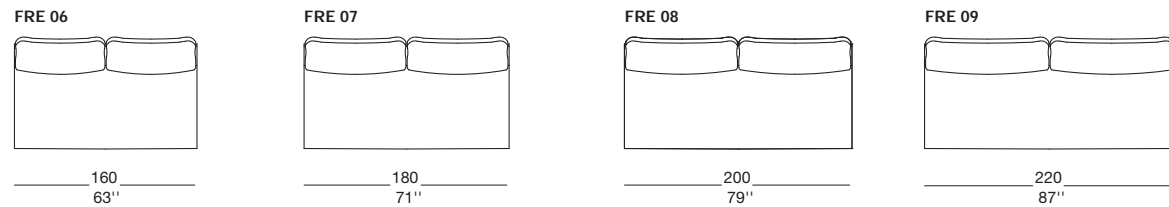
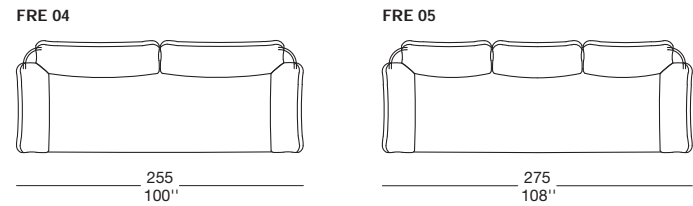
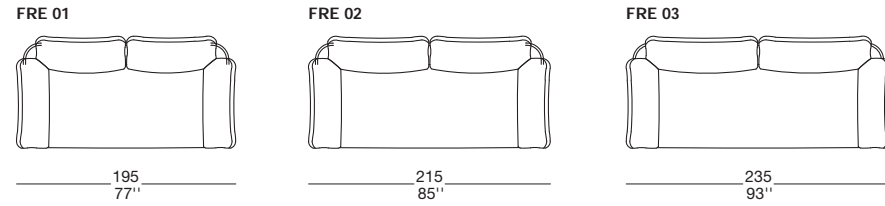
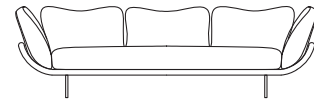
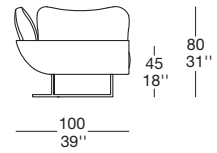

Freespirit
Giuseppe Viganò / Studio Viganò

| Sofa

|

Freespirit
Giuseppe Viganò / Studio Viganò

| Sofa

| 15 |

FRE 34

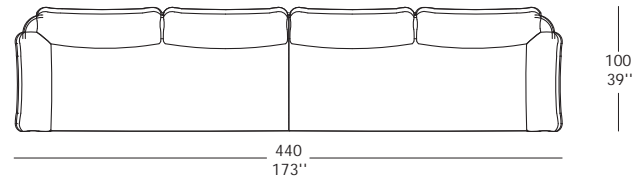

FRE 35

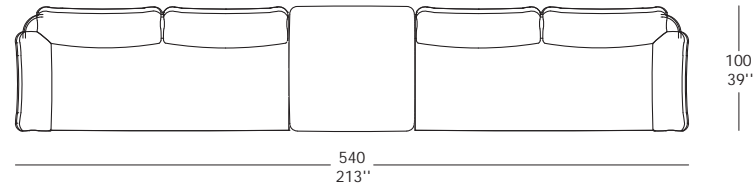

FRE 36

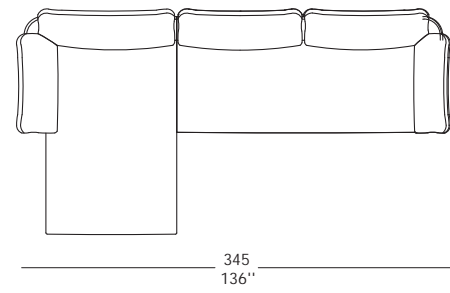

FRE 37

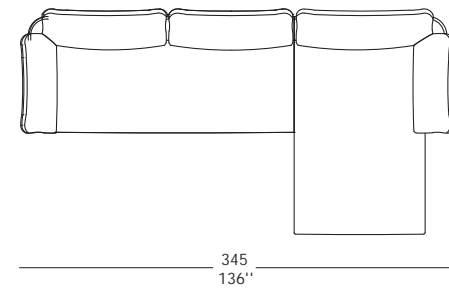

FRE 38

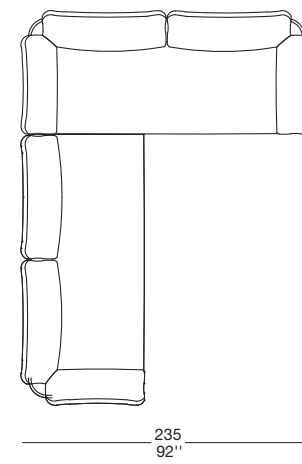

FRE 39

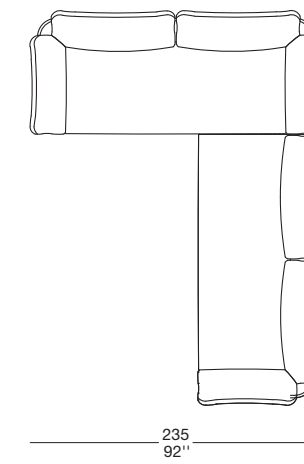

FRE 40

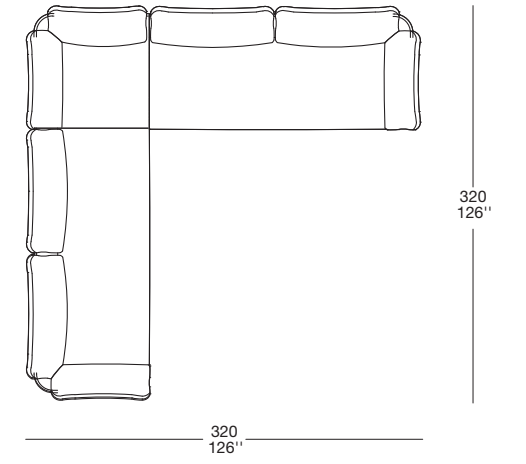

FRE 41

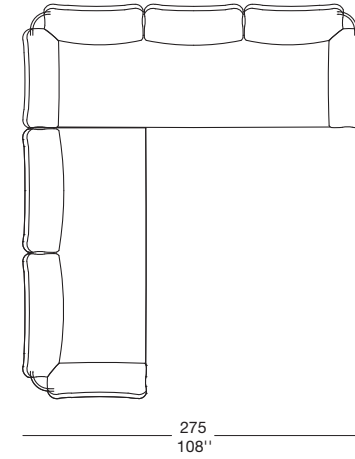

FRE 42

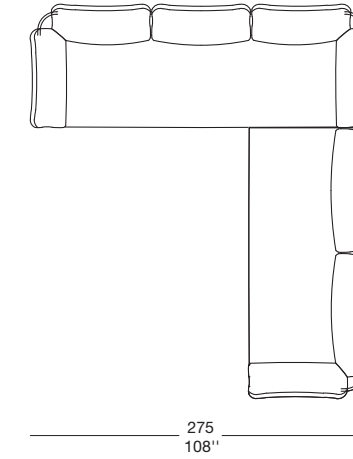

FRE 43

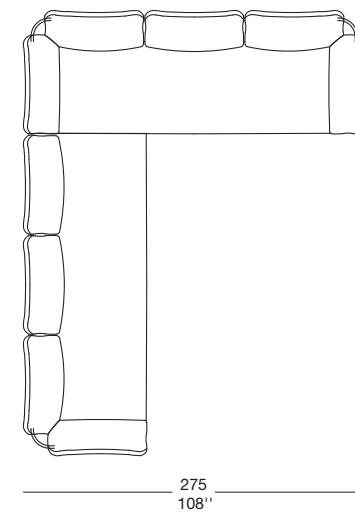

FRE 44

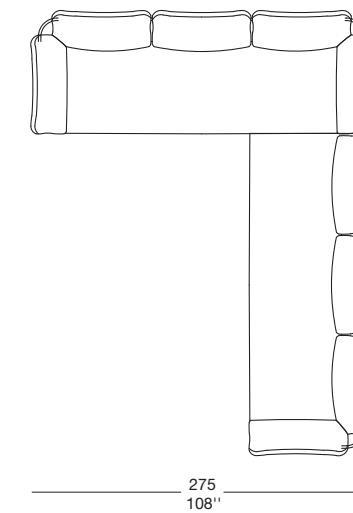

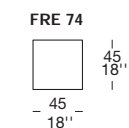
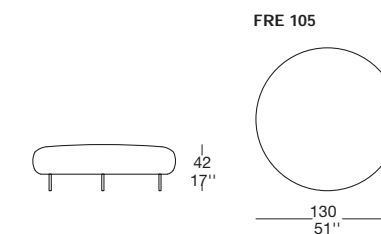
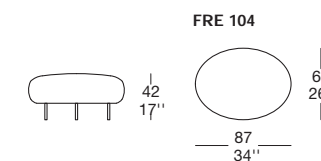
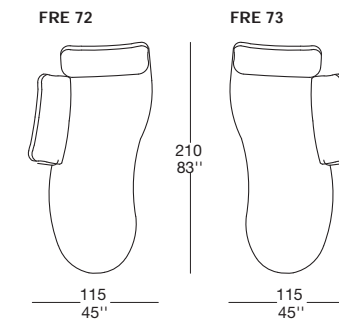
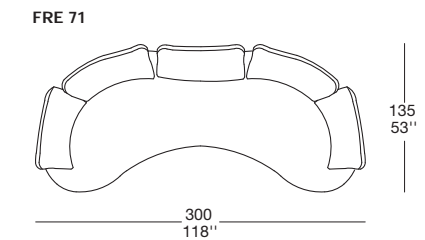
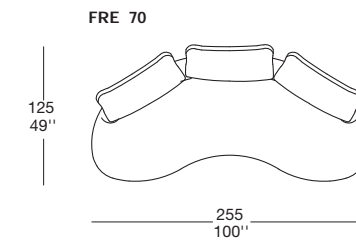
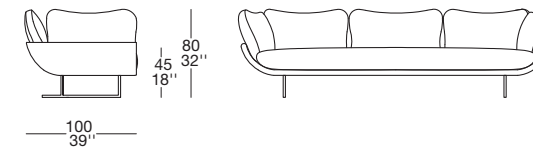
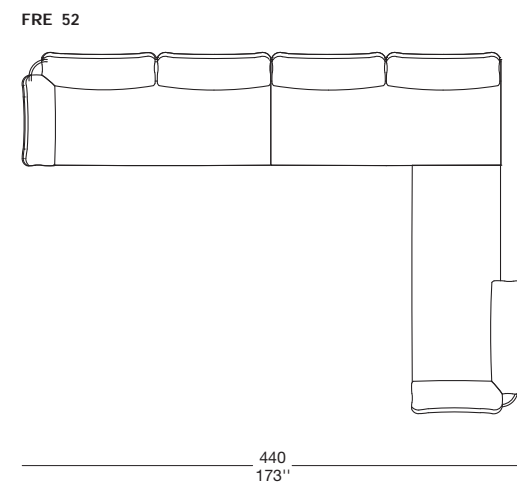
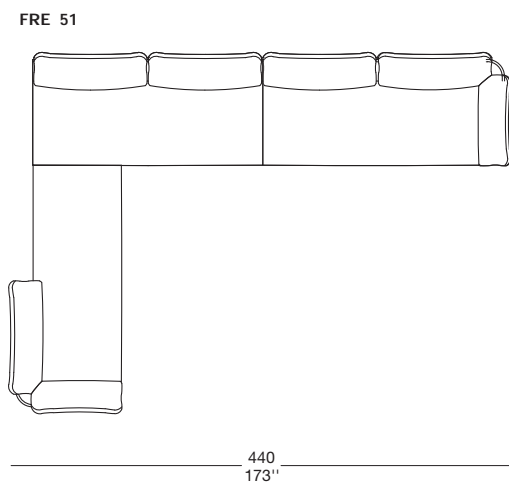
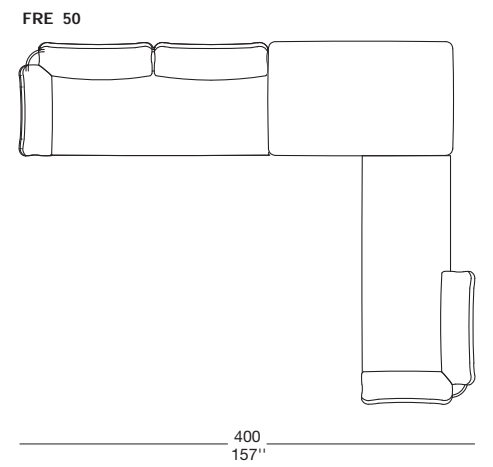
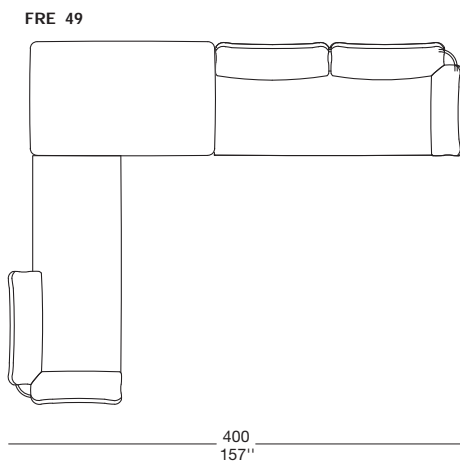
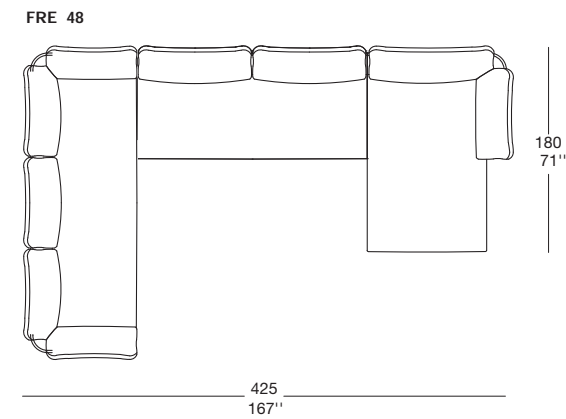
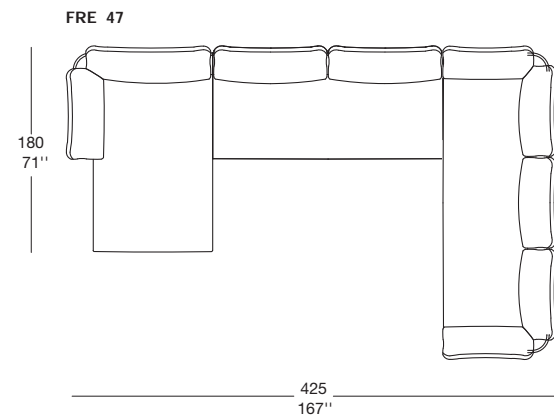
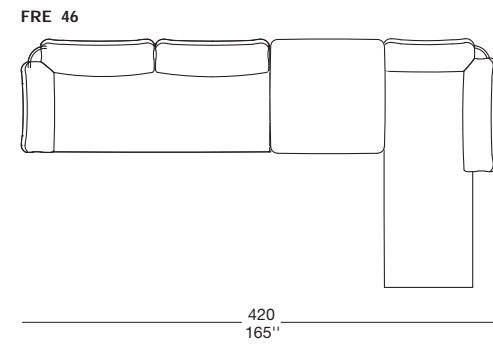
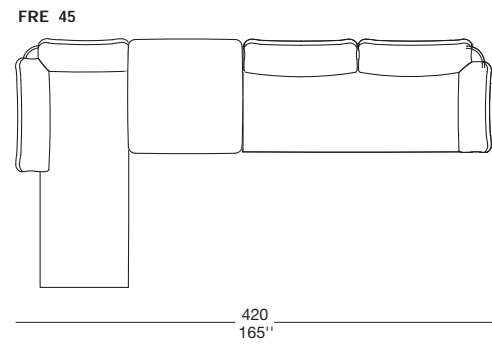

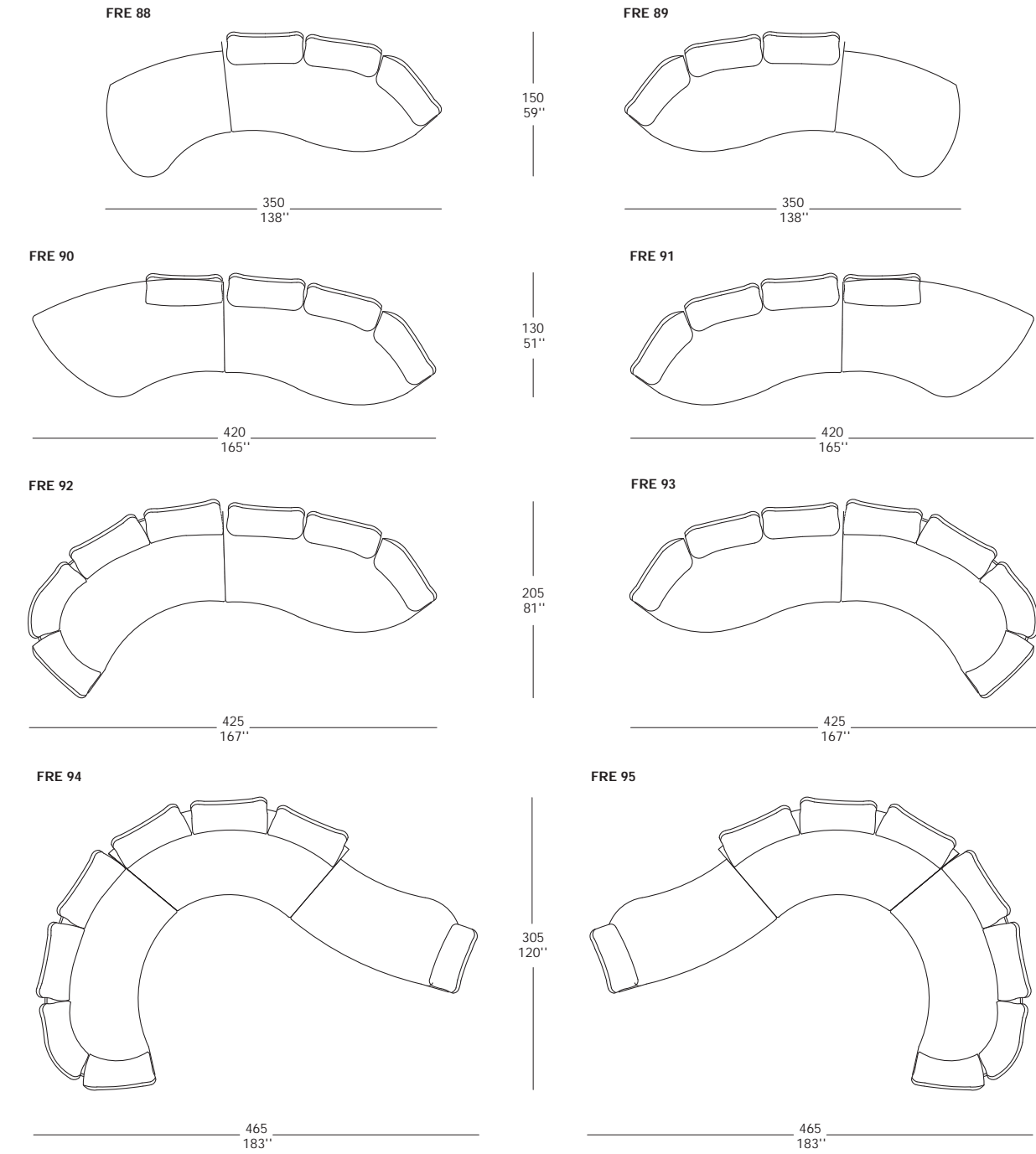
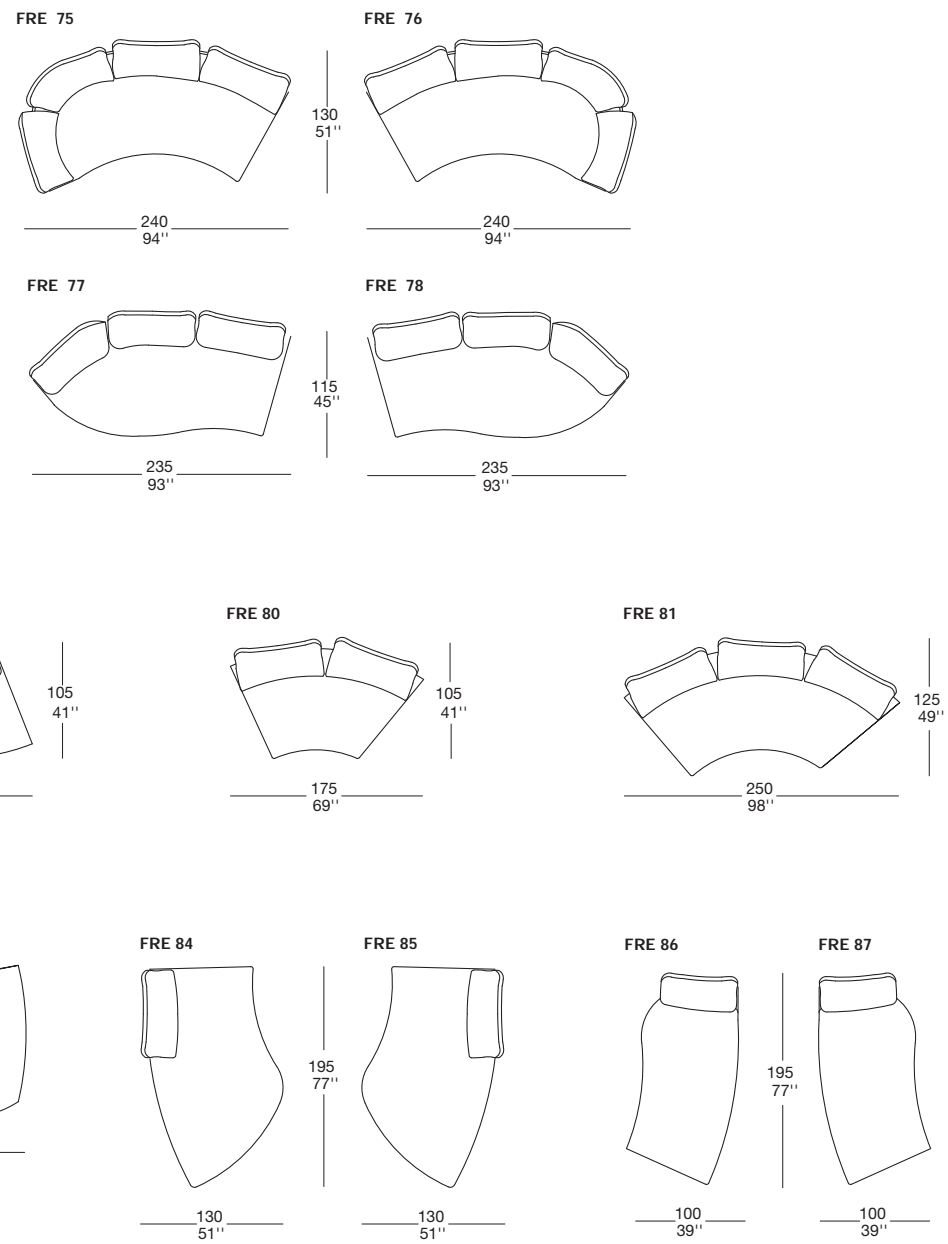

Freespirit Curvo
Giuseppe Viganò / Studio Viganò

| Sofa

|

Freespirit Curvo
Giuseppe Viganò / Studio Viganò

| Sofa

21 |

FRE 96

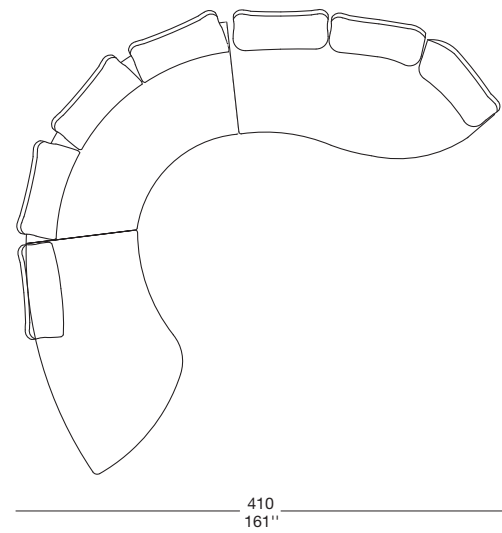

FRE 97

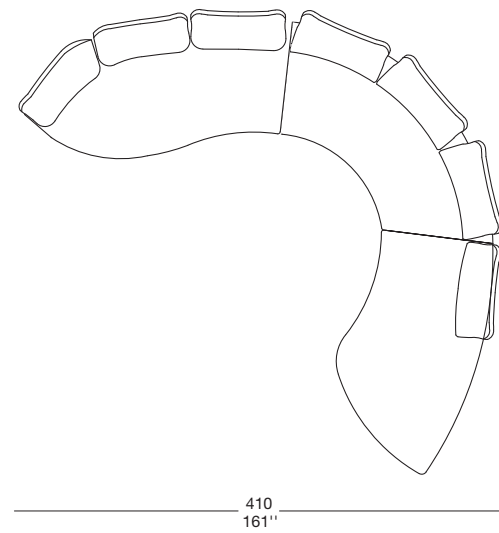

FRE 100

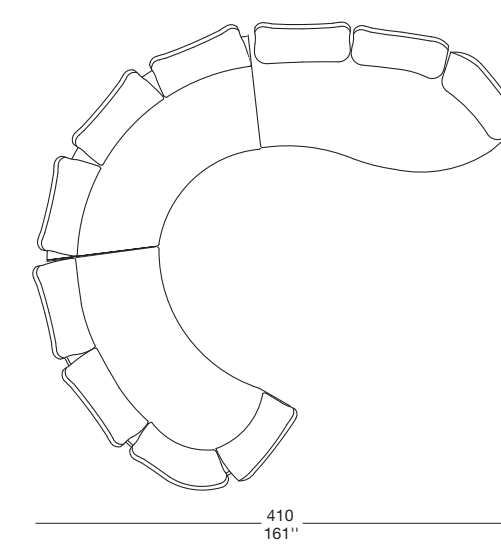

FRE 101

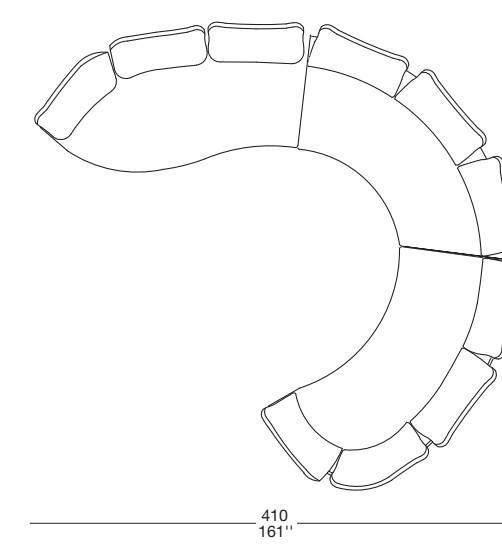

FRE 98

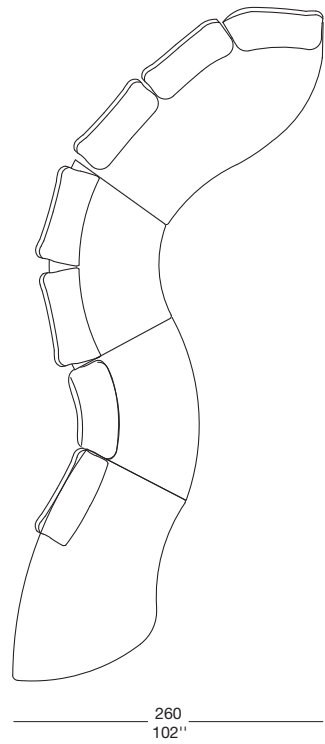

FRE 99

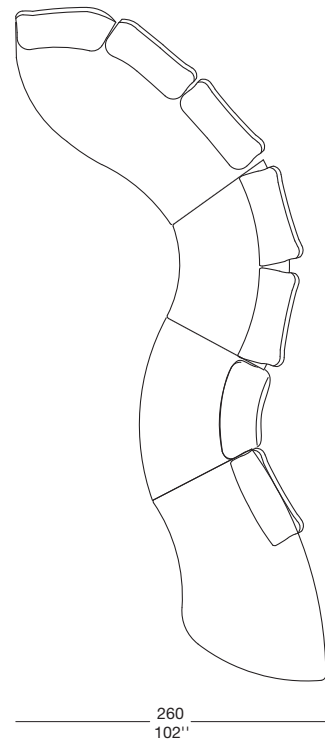

FRE 102

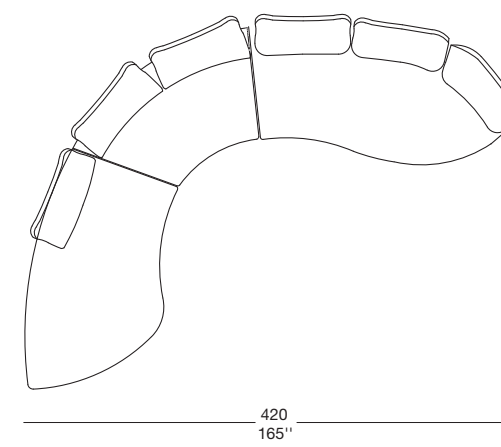

FRE 103

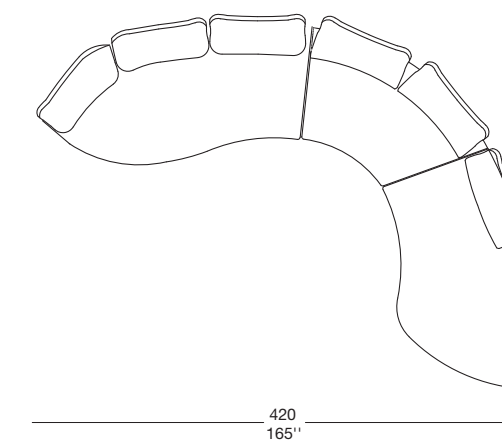

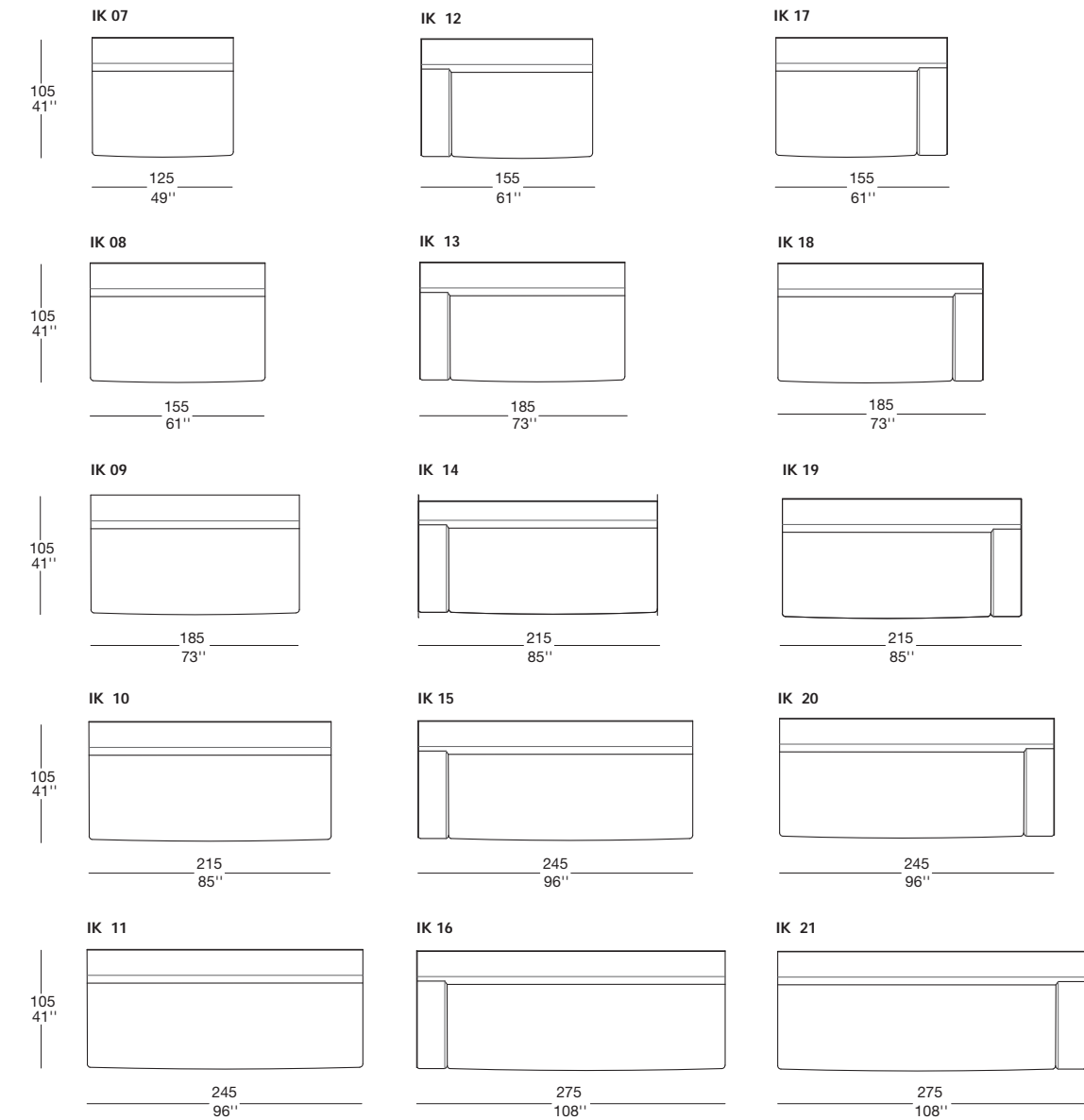
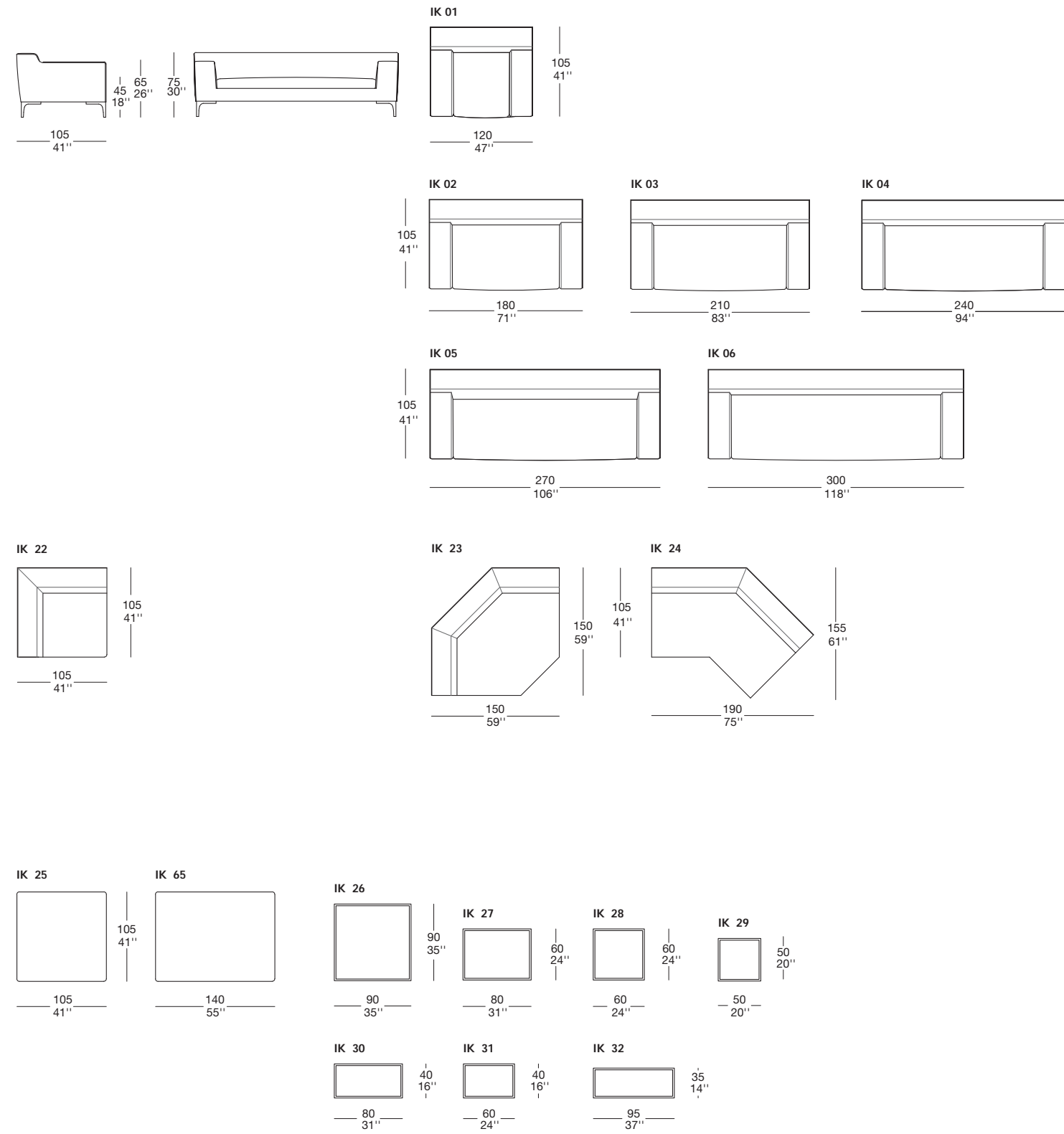

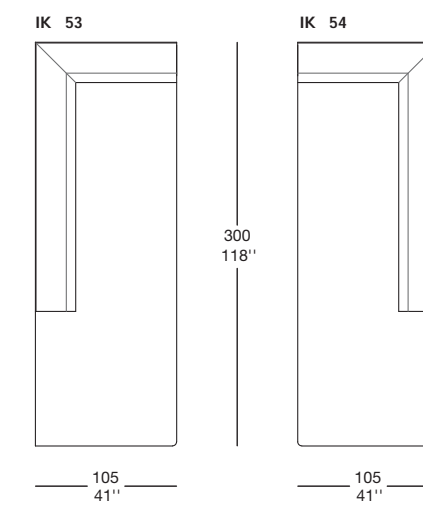
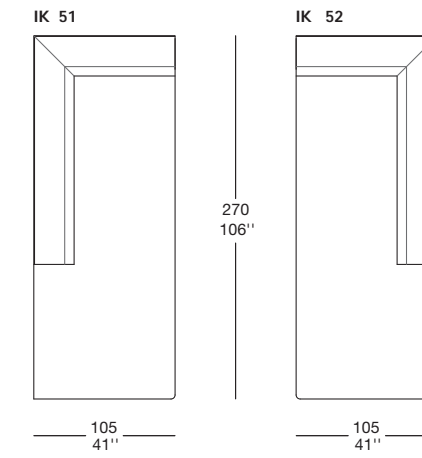
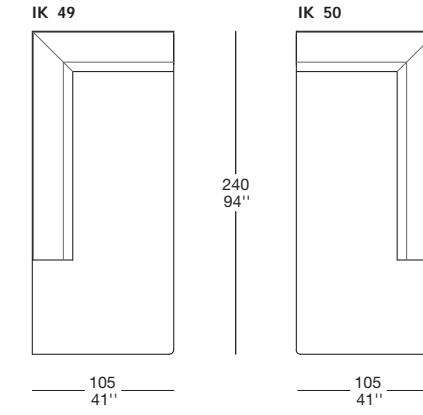
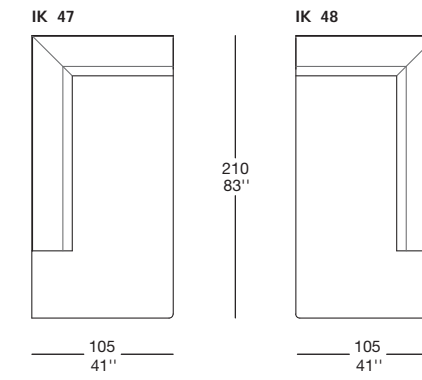
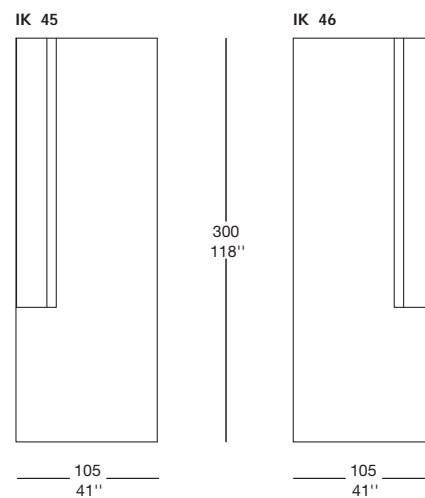
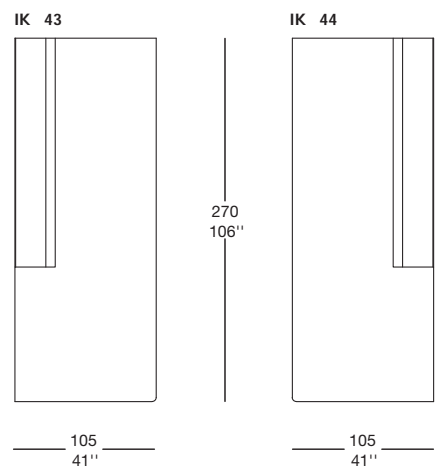
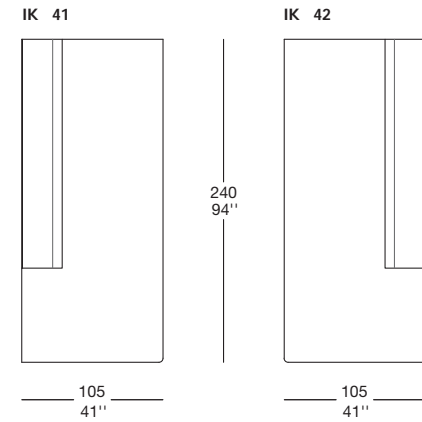
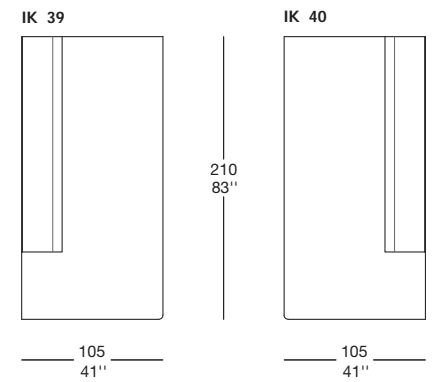
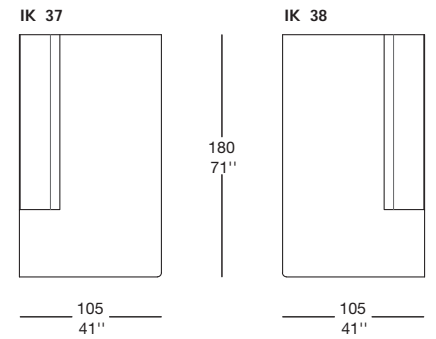
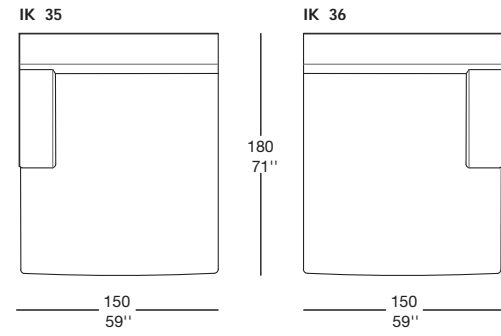
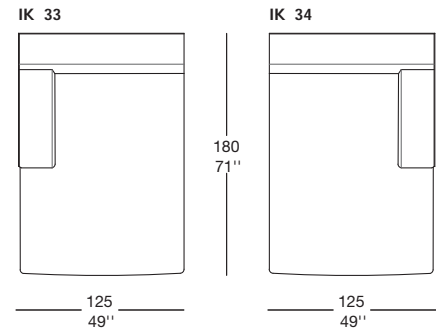

IK 55

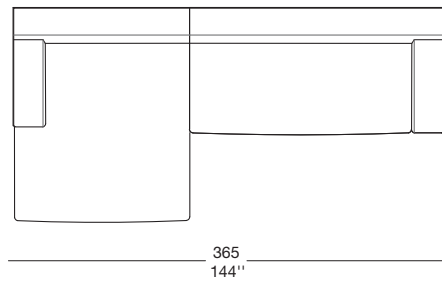

IK 56

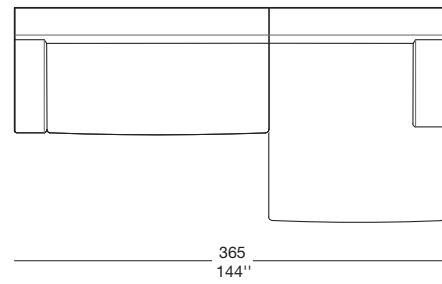

IK 57

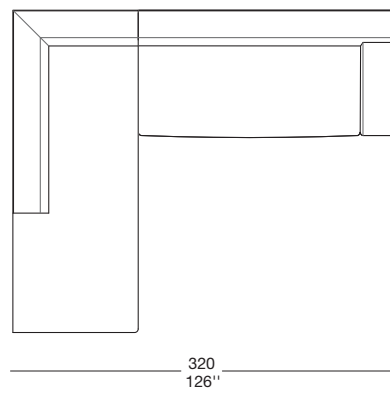

IK 58

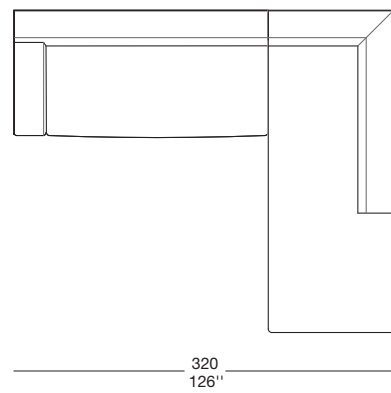

IK 59

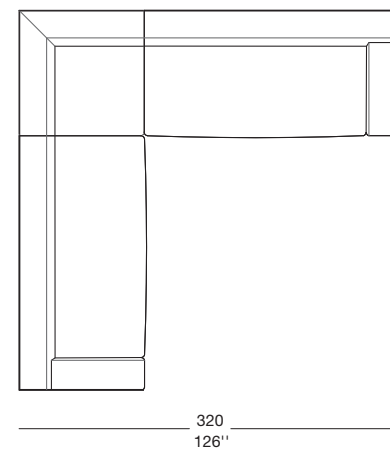

IK 60

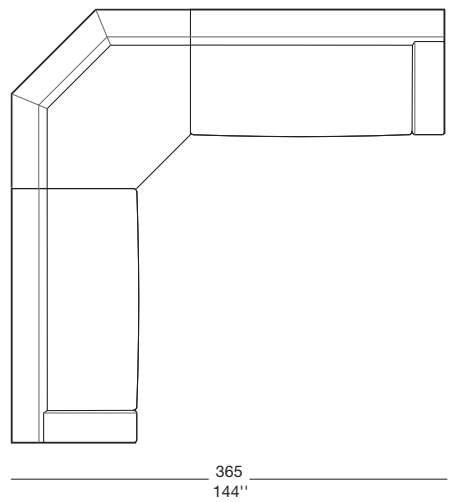

IK 61

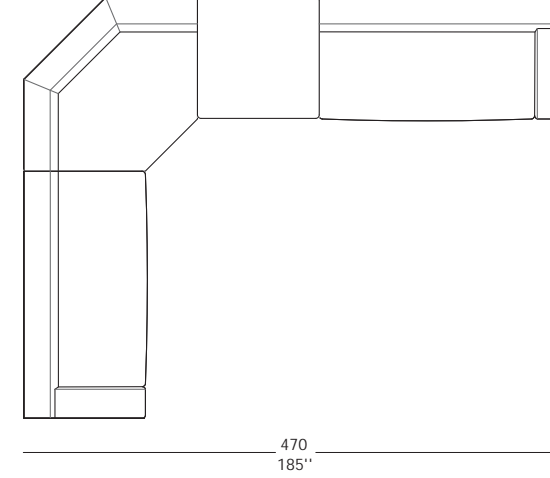

IK 62

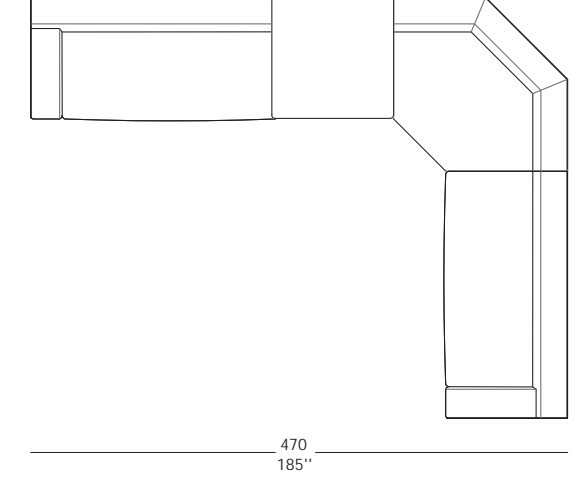

IK 63

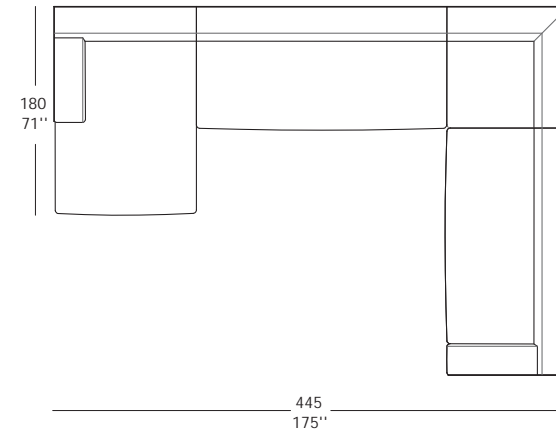

IK 64

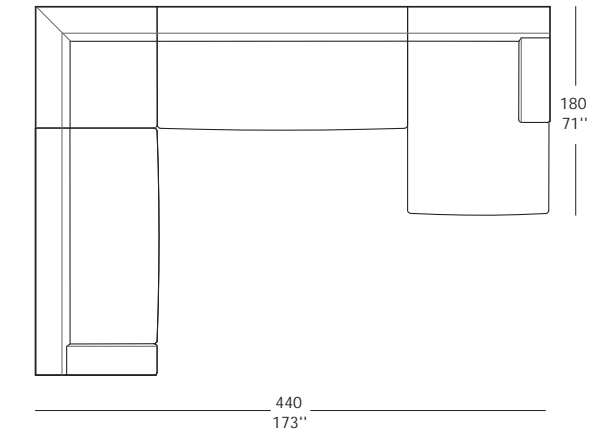

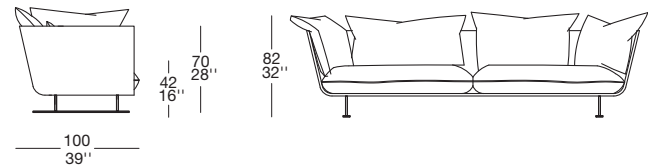

MOO 01

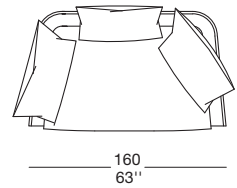

MOO 02

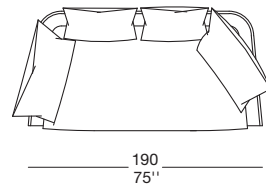

MOO 03

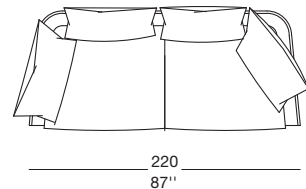

MOO 04

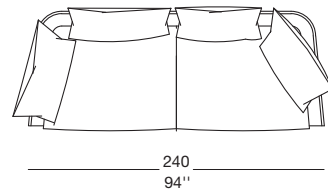

MOO 05

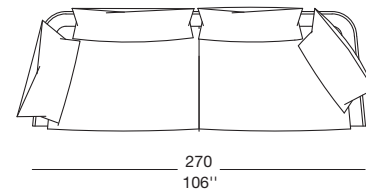

MOO 06



MOO 07

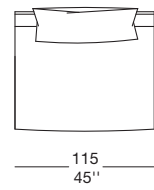

MOO 08

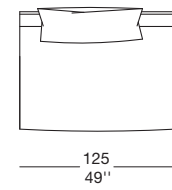

MOO 09



MOO 10

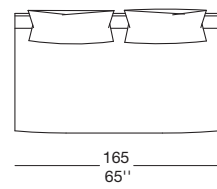

MOO 11



MOO 12

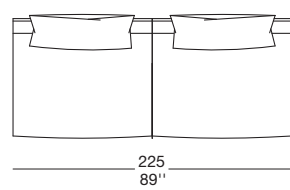

MOO 13

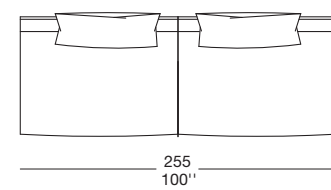

MOO 14

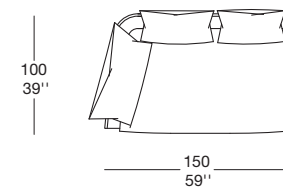

MOO 15

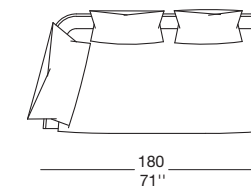

MOO 16

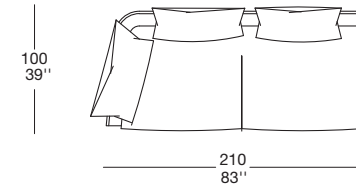

MOO 17

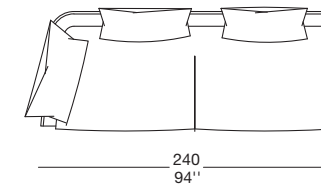

MOO 18

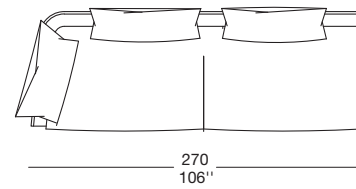

MOO 19

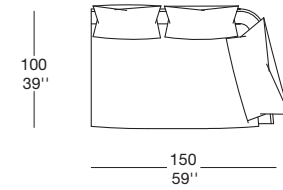

MOO 20

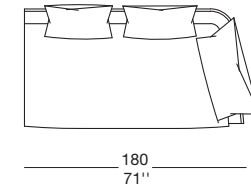

MOO 21

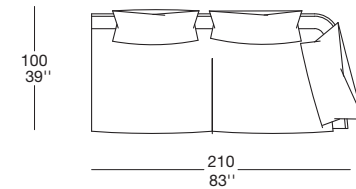

MOO 22

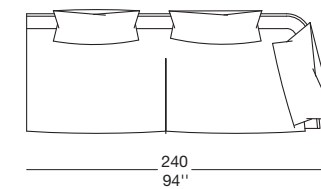

MOO 23

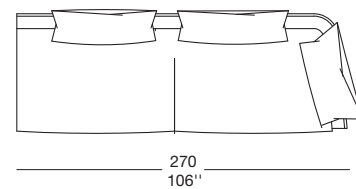

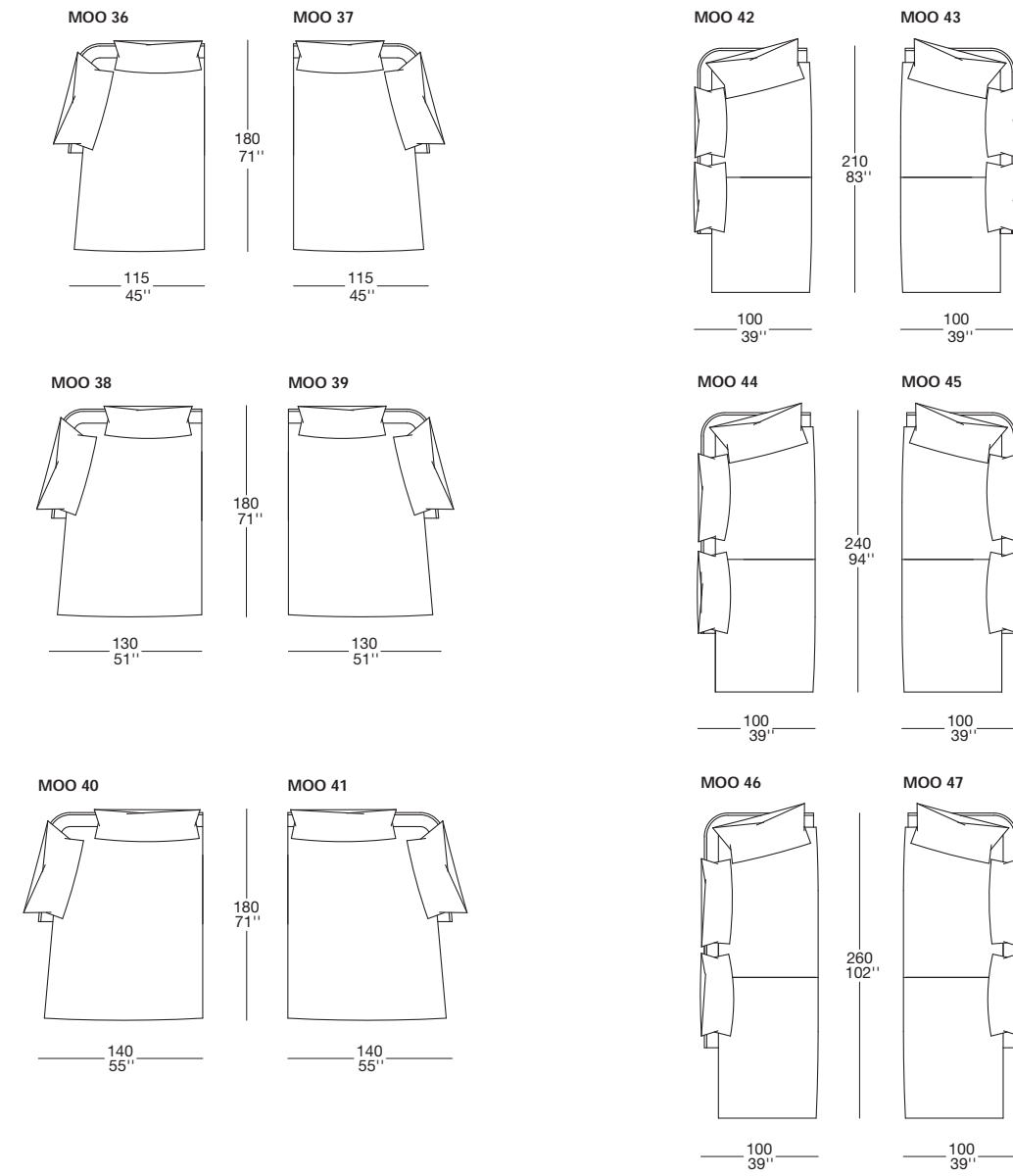
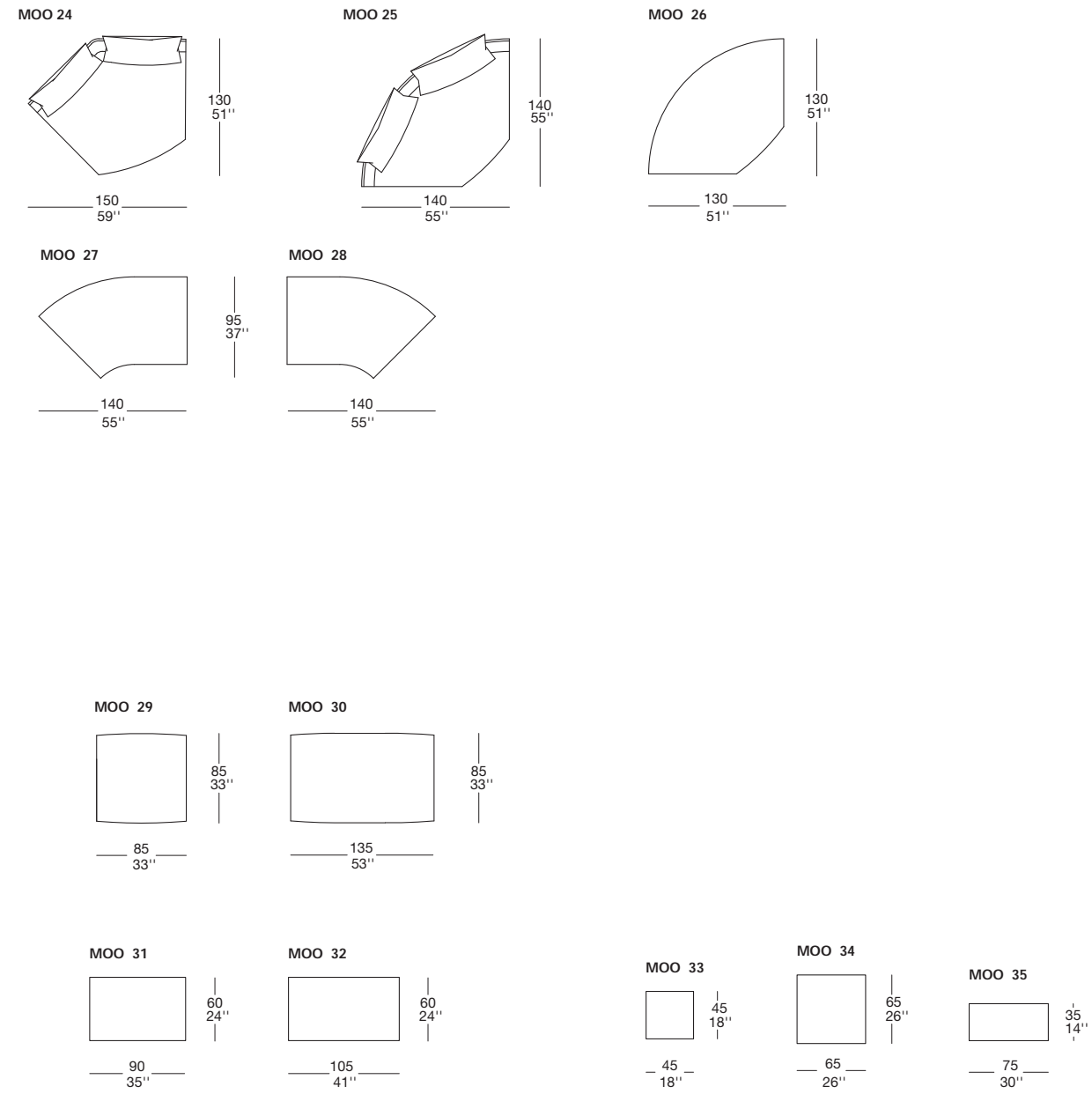

MOO 48

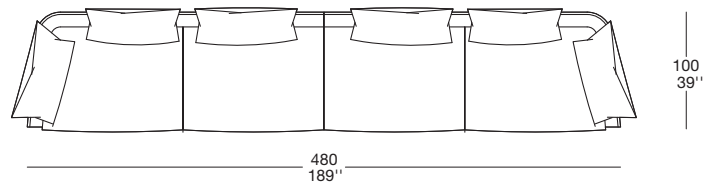

MOO 49

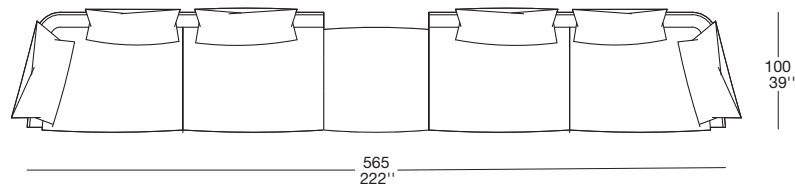

MOO 50

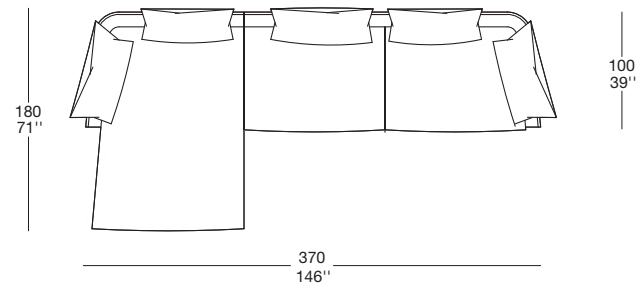

MOO 51

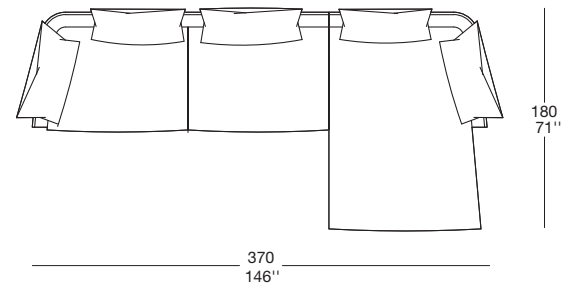

MOO 52

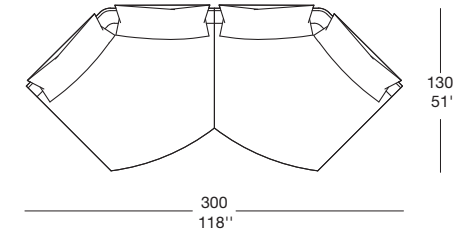

MOO 53

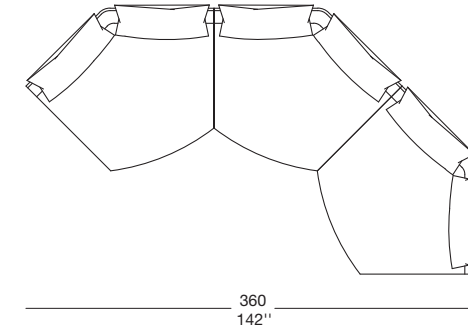

MOO 55

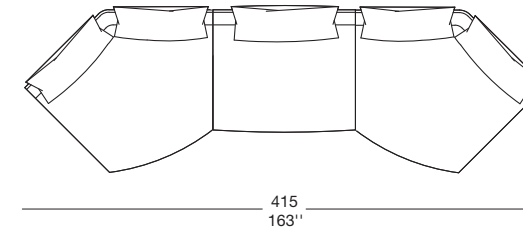

MOO 56

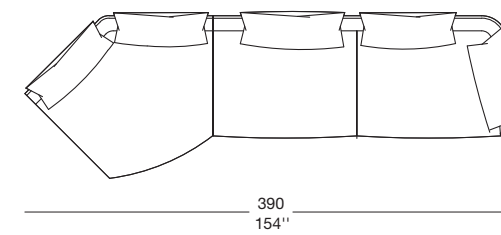

MOO 54

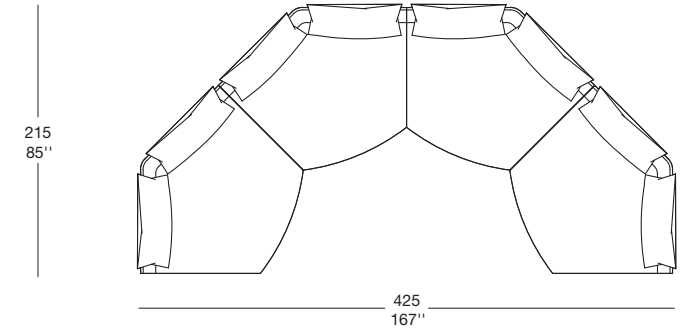

MOO 57

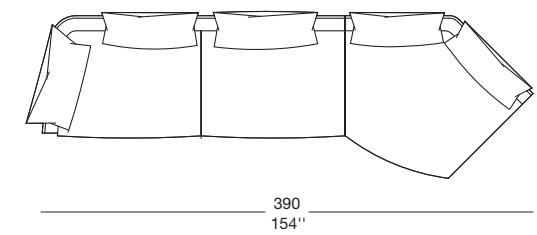

MOO 58

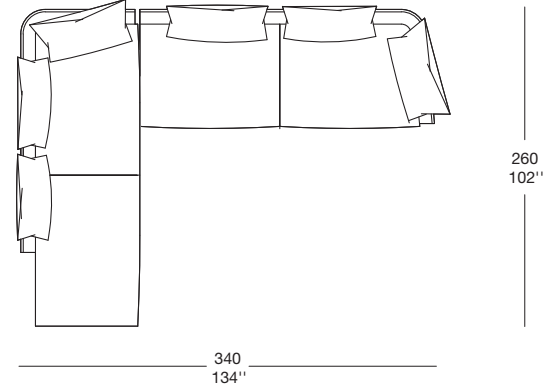

MOO 59

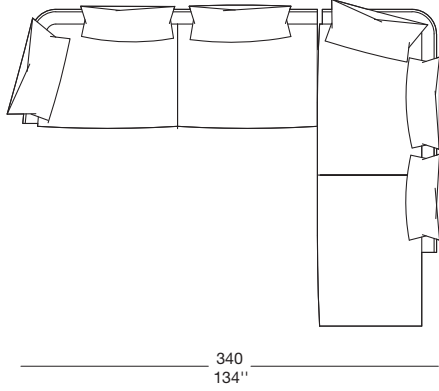

MOO 62

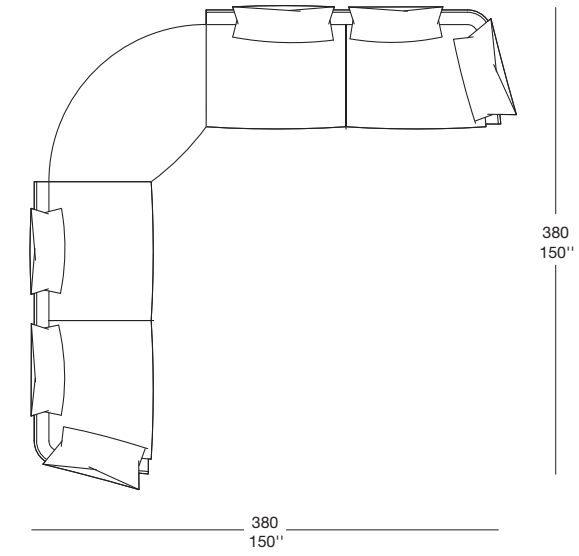

MOO 63

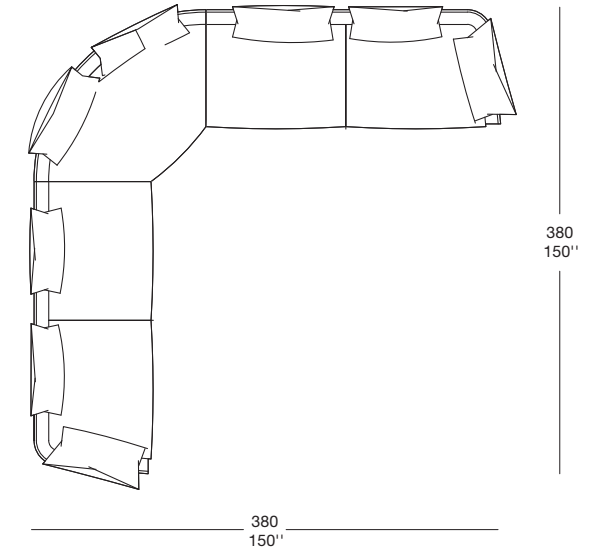

MOO 60

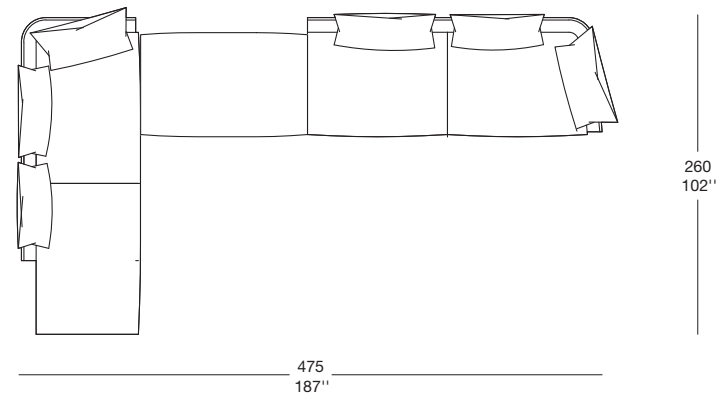

MOO 61

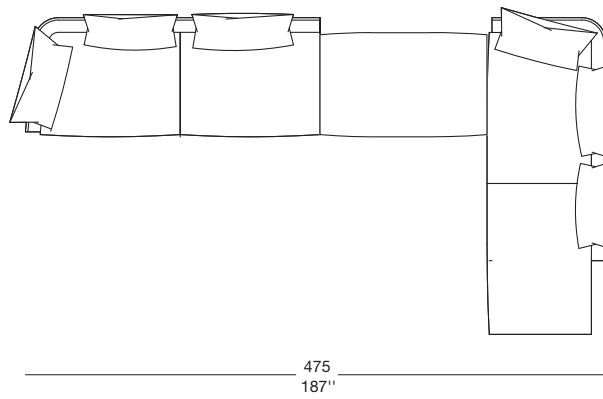

MOO 64

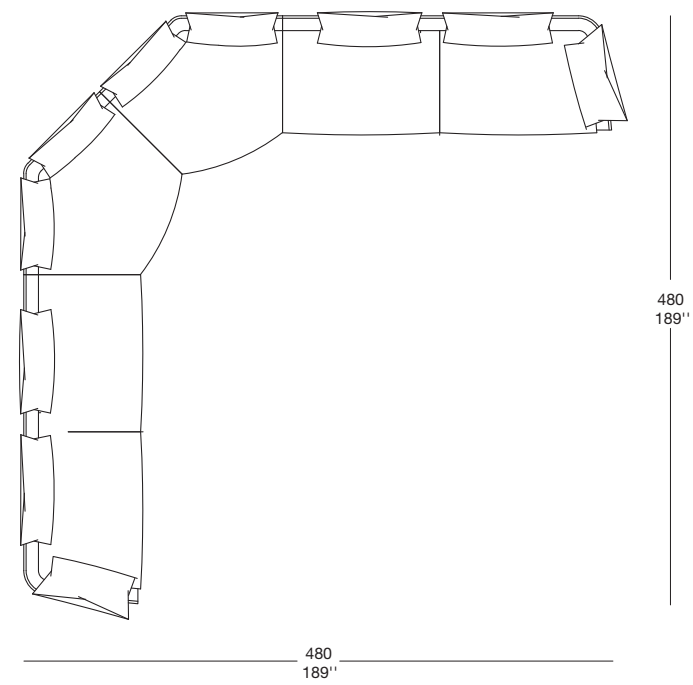

MOO 65

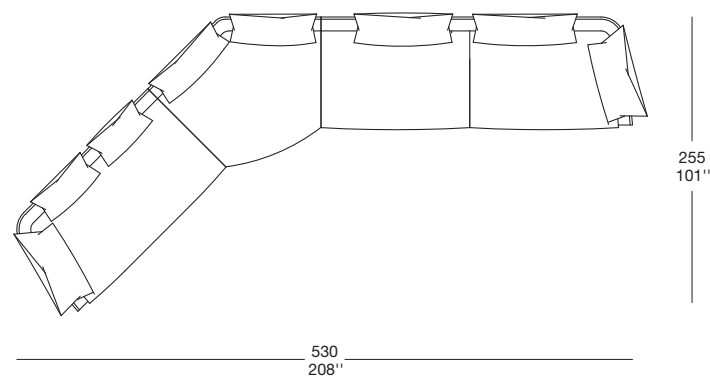

MOO 66

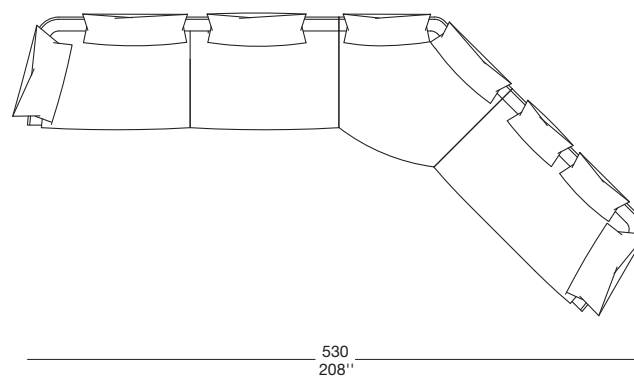

MOO 67

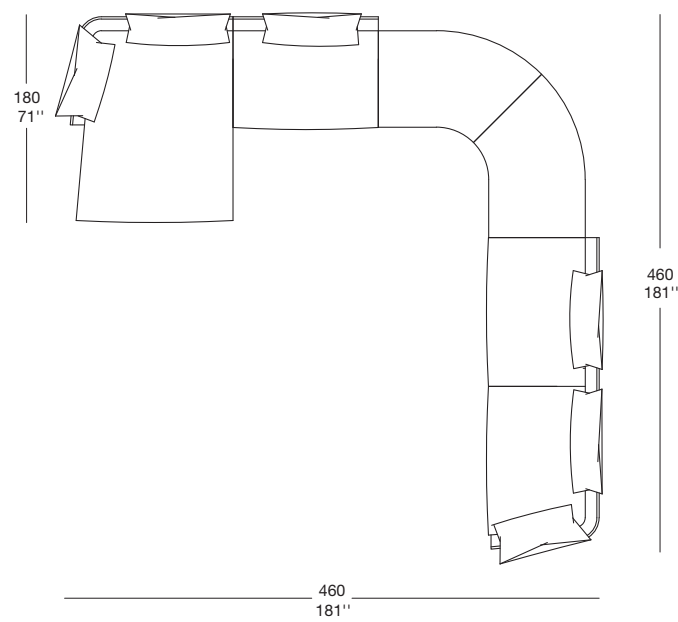

MOO 68

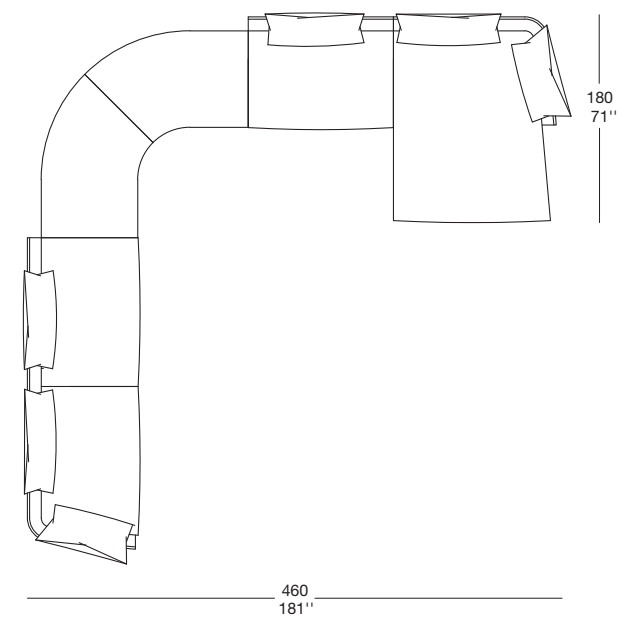

MOO 69

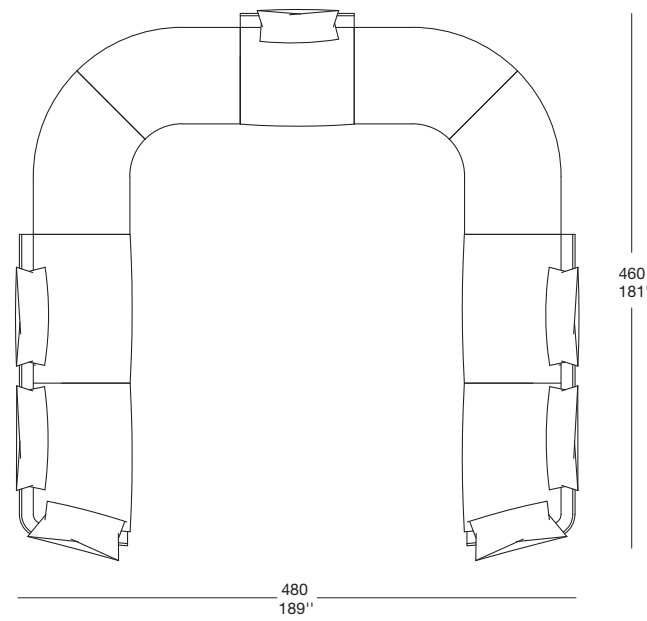

Airstrike

Giuseppe Viganò / Studio Viganò

| Armchairs

|

FISSA / FIX

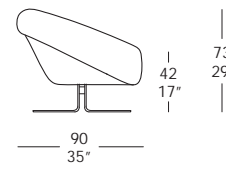

AIR 01

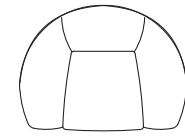
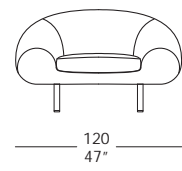

GIREVOLE / SWIVEL

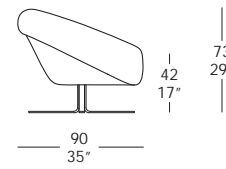

AIR 02

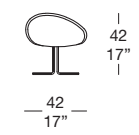
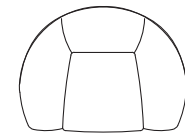
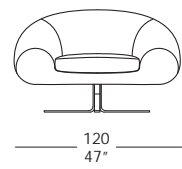

AIR 03

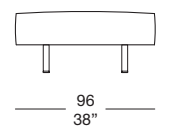

Antelope

Giuseppe Viganò / Studio Viganò

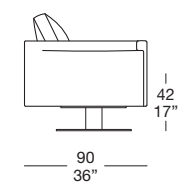

ANT 01

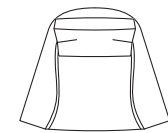
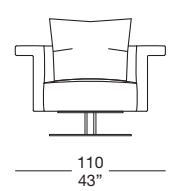

Giorgio

Giuseppe Viganò / Studio Viganò

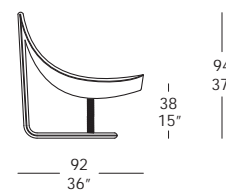

GIO 01

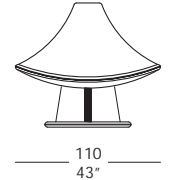

Elixir

Giuseppe Viganò / Studio Viganò

| Low Tables

|

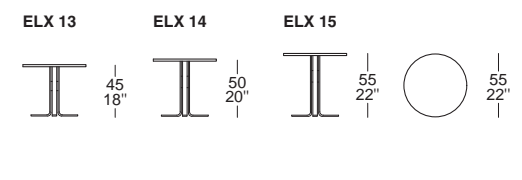
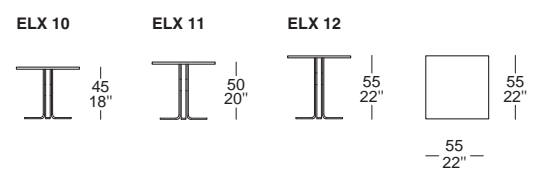
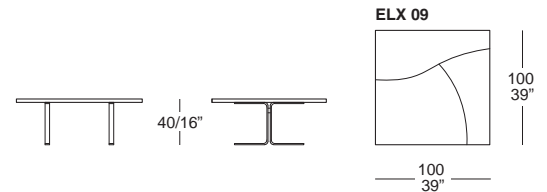
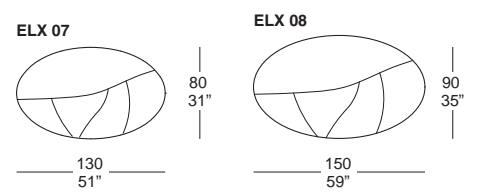
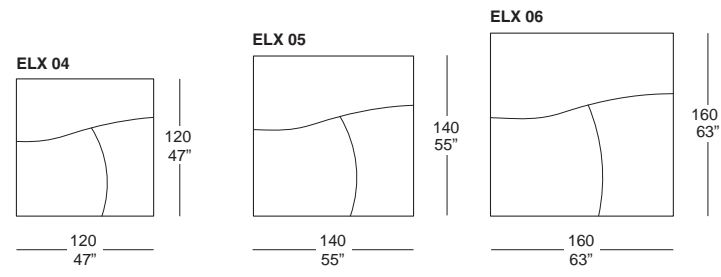
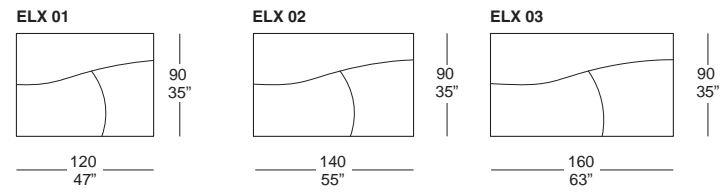
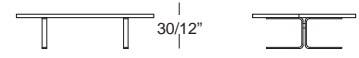

Elixir

Giuseppe Viganò / Studio Viganò

| Low Tables

41 |

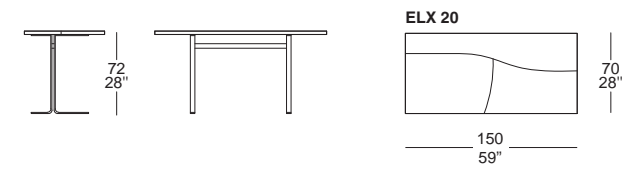
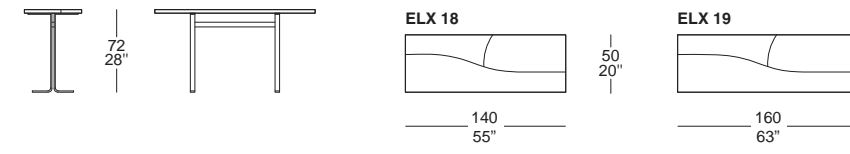
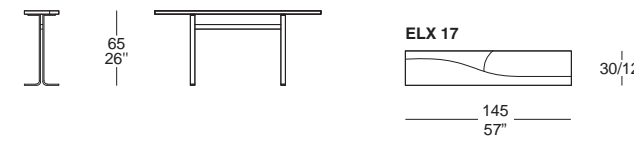
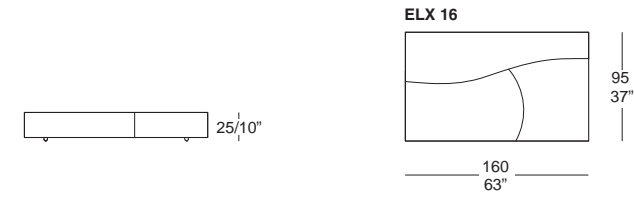

Tracer

Giuseppe Viganò / Studio Viganò

| Low Tables

|

Tracer Line

Giuseppe Viganò / Studio Viganò

| Low Tables

43 |

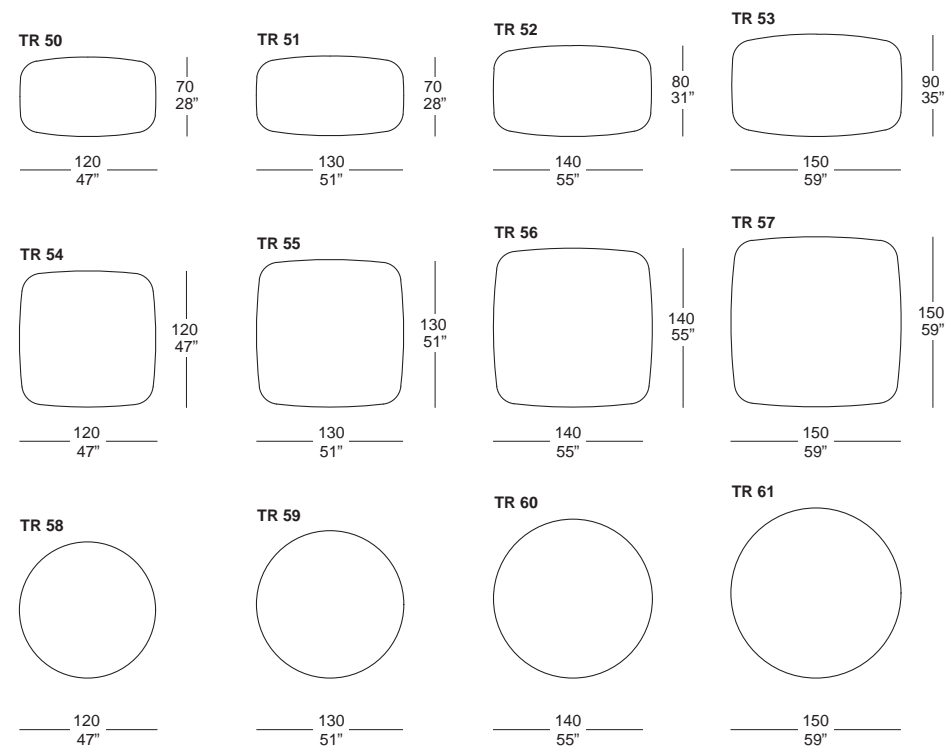
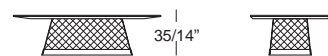

N.B. Top: prodotto in tutte le nostre finiture di legni
 Bordo sagomato: prodotto solo nelle finiture di legni laccati
 Base: metallo nelle finiture della nostra collezione
 N.B. Top: produced in all our wooden finishings
 Shaped border: produced only in lacquered wooden finishings
 Base: metal with finishes from our collection

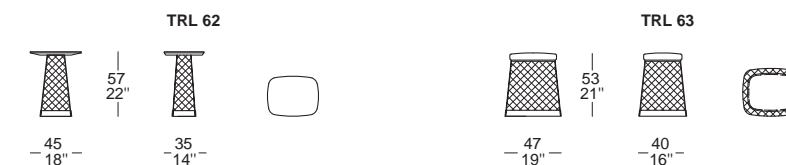
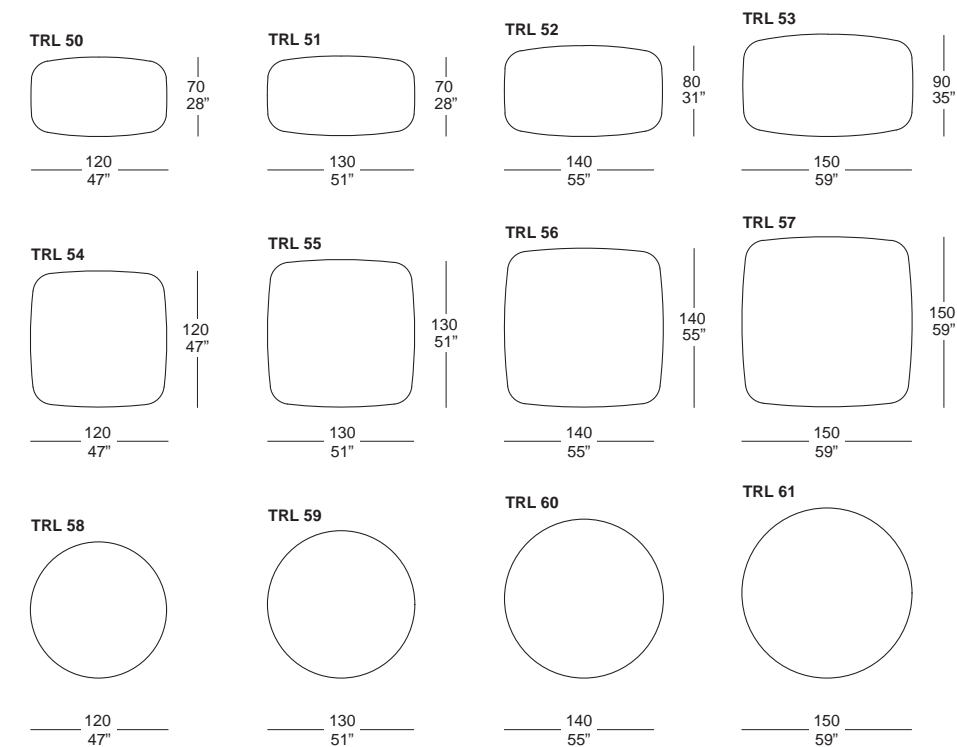
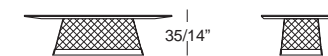

N.B. Top: prodotto in tutte le nostre finiture di legni
 Base: metallo nelle finiture della nostra collezione
 N.B. Top: produced in all our wooden finishings
 Base: metal with finishes from our collection

Vega
Giorgio Saporiti

| Low Tables

|

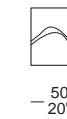
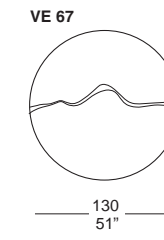
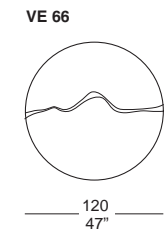
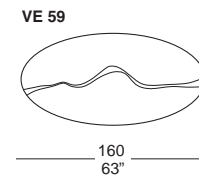
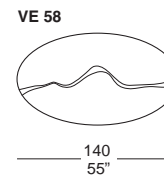
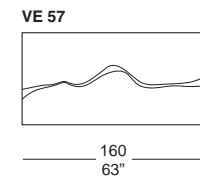
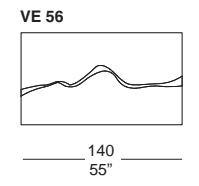
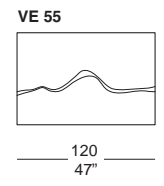
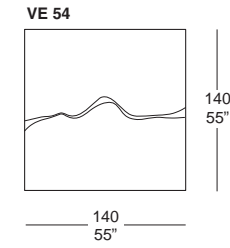
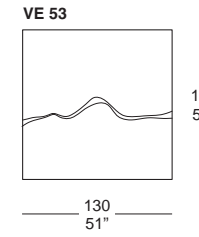
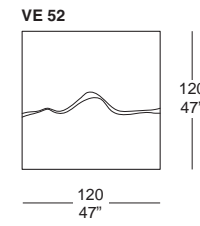
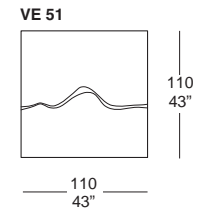
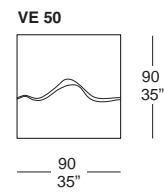
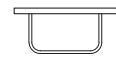

Shiva
Giuseppe Viganò / Studio Viganò

| Low Tables

45 |

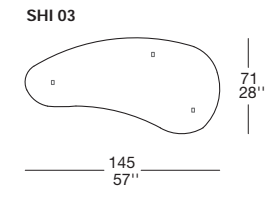
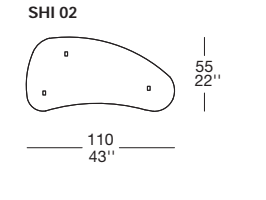
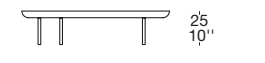
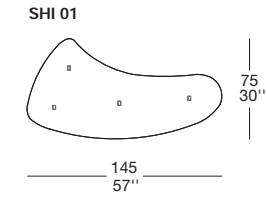
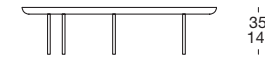

Zaren
Giuseppe Viganò / Studio Viganò

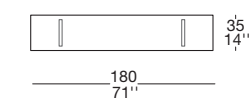
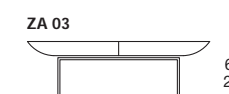
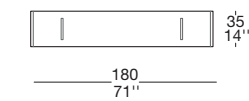
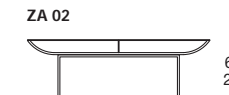
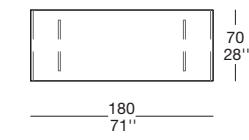
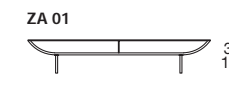
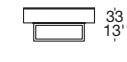

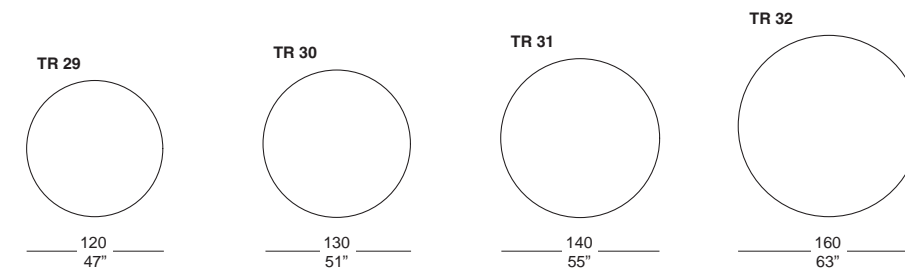
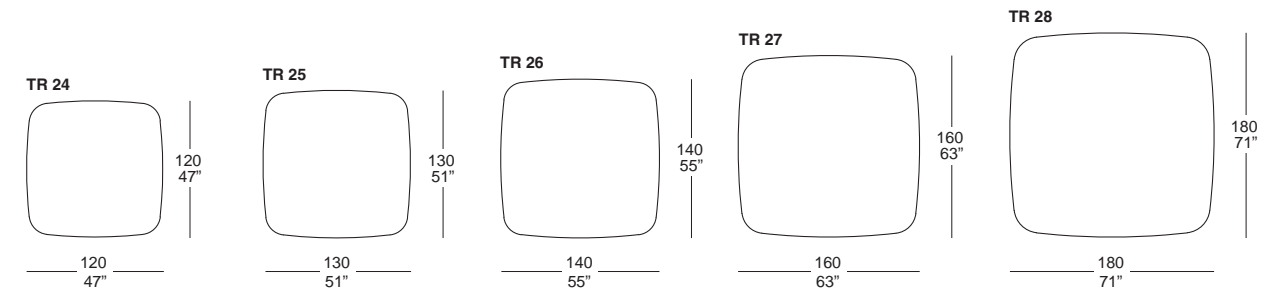
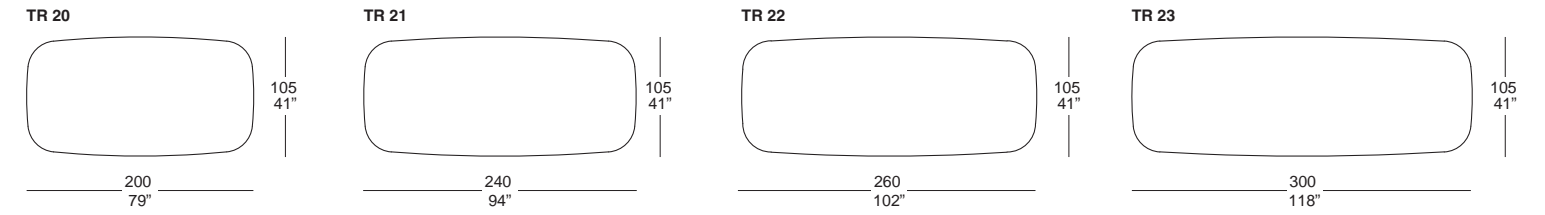
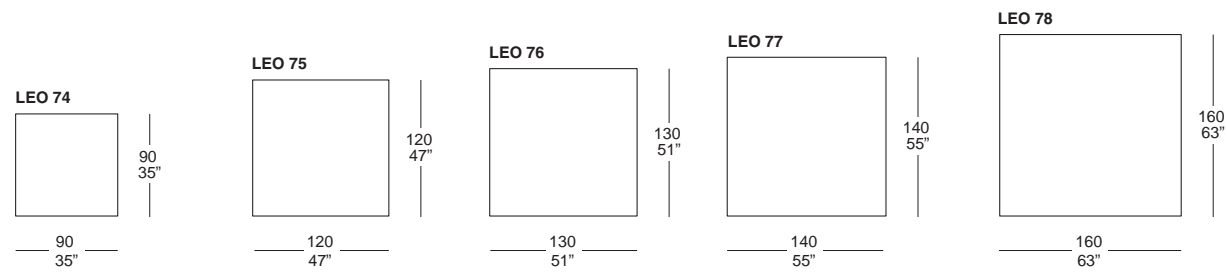
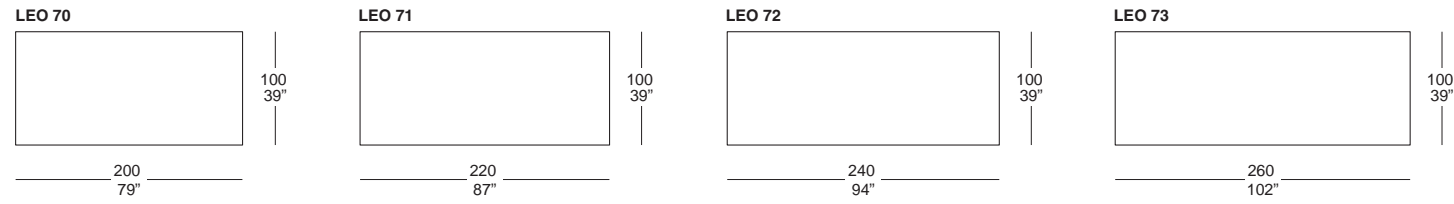

N.B. Top: prodotto in tutte le nostre finiture di legni
Bordo sagomato: prodotto solo nelle finiture di legni laccati
Base: metallo nelle finiture della nostra collezione

N.B. Top: produced in all our wooden finishings
Shaped border: produced only in lacquered wooden finishings
Base: metal with finishes from our collection

Tracer Line

Giuseppe Viganò / Studio Viganò

| Tables

|

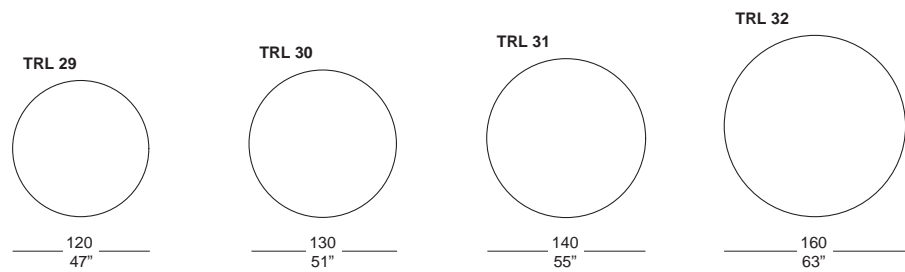
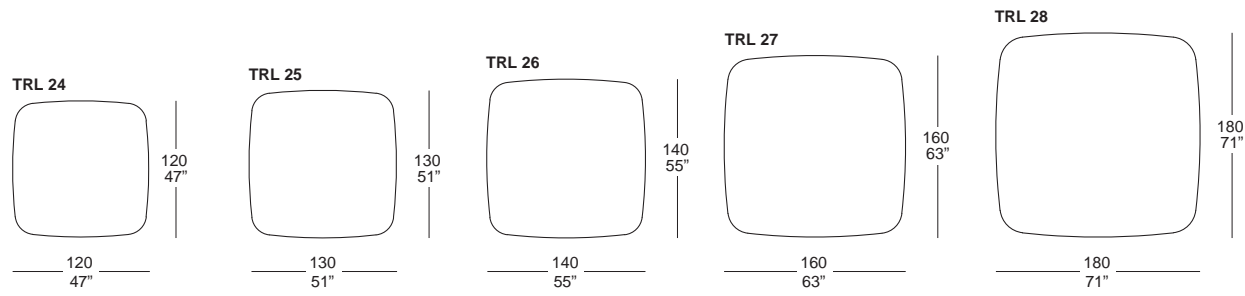
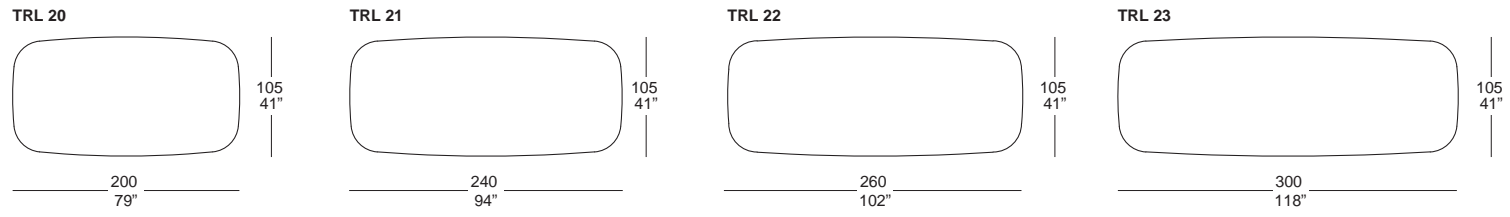

Vega

Giorgio Saporiti

| Tables

| 49

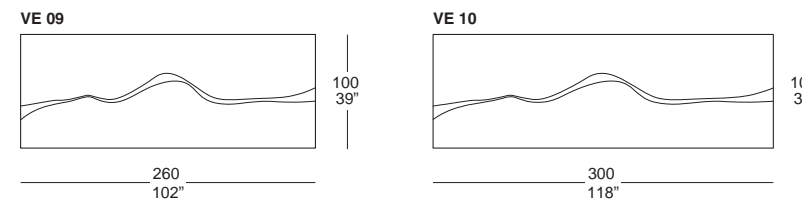
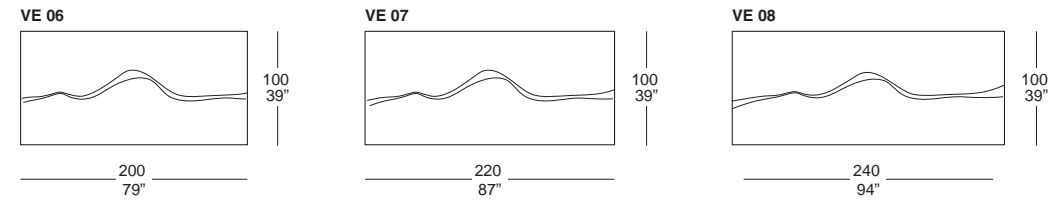
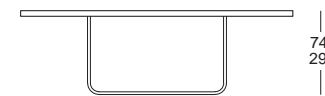
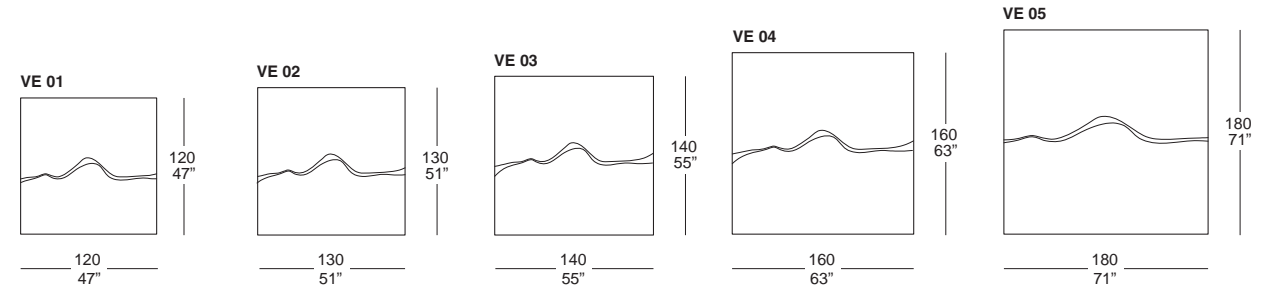
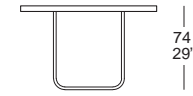

N.B. Top: prodotto in tutte le nostre finiture di legni
Base: metallo nelle finiture della nostra collezione
N.B. Top: produced in all our wooden finishings
Base: metal with finishes from our collection

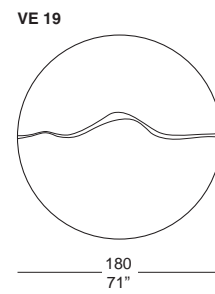
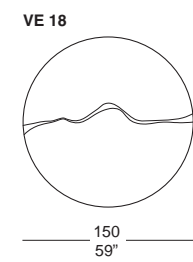
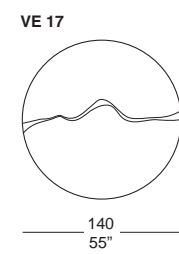
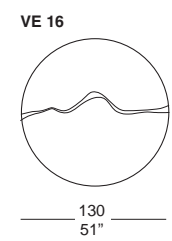
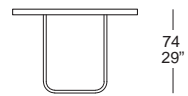
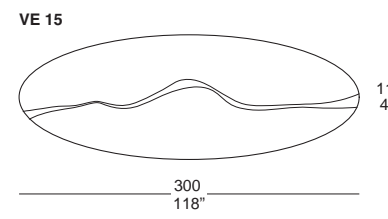
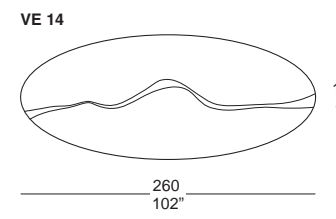
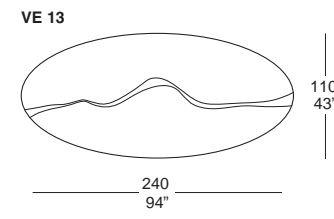
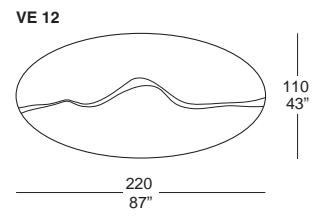
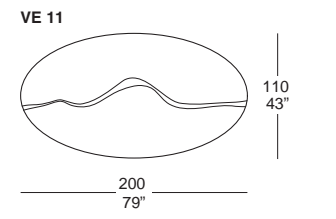

Airstrike

Giuseppe Viganò / Studio Viganò

| Chairs

|

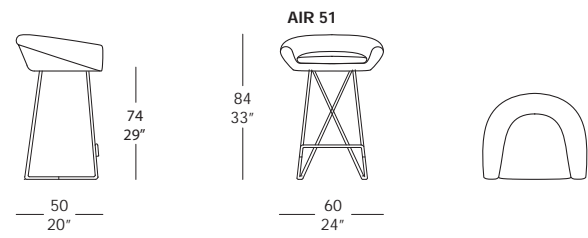
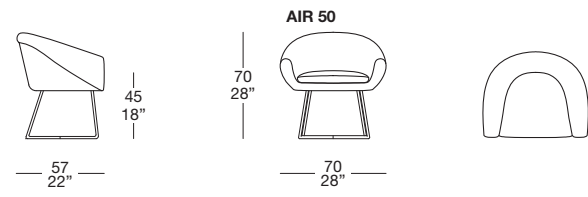

Free Spirit

Giuseppe Viganò / Studio Viganò

| Beds

|

Ikon

Giuseppe Viganò / Studio Viganò

| Beds

| 55 |

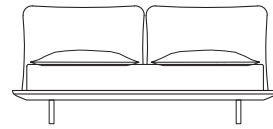
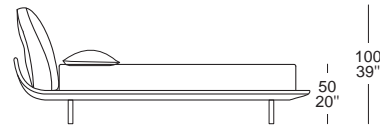

FRE 150 ST

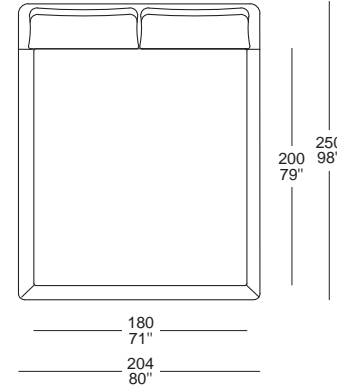

FRE 152 QS

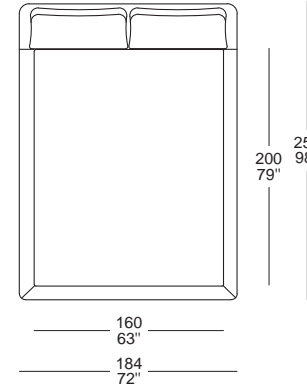

FRE 154 KS

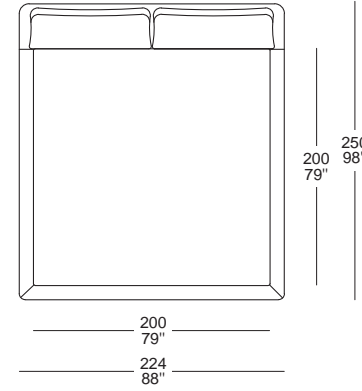

FRE 156

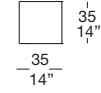

FRE 157

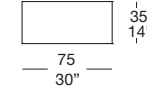

FRE 158

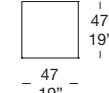

FRE 159

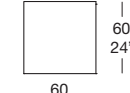

IK 150 ST

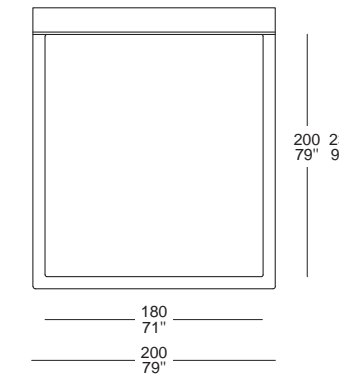

IK 152 QS

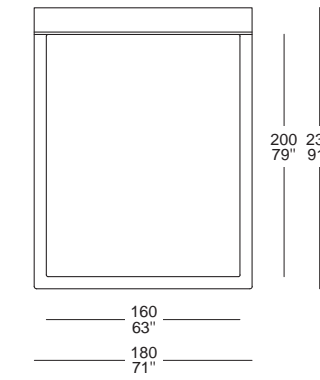

IK 154 KS

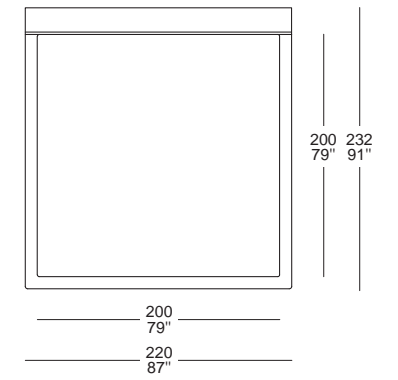

IK 156

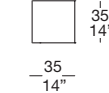

IK 157

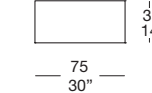

IK 158

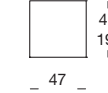

IK 159

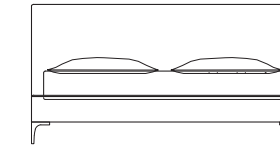
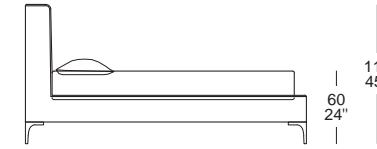
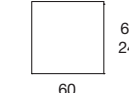

Night Side

Giuseppe Viganò / Studio Viganò

| Beds

|

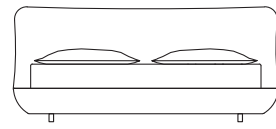
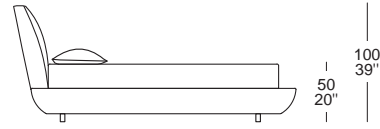

NG 01 ST

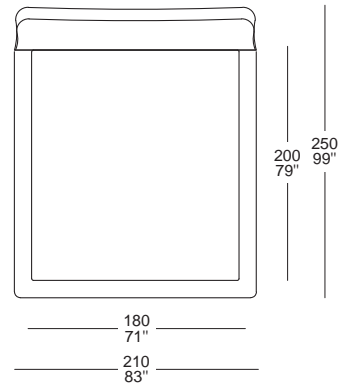

NG 03 QS

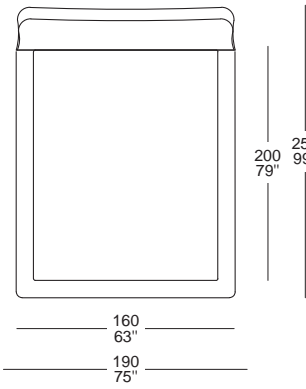

NG 05 KS

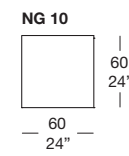
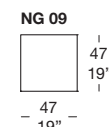
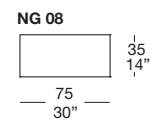
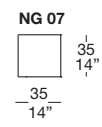
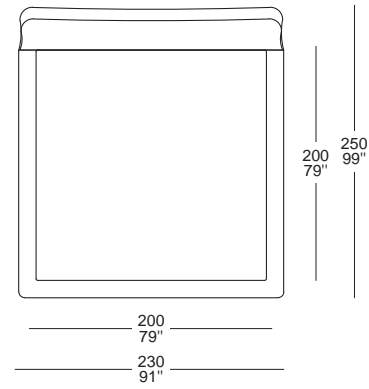

Stallior

Giuseppe Viganò – Studio Viganò

| Wooden Furnitures

|

Tracer

Giuseppe Viganò / Studio Viganò

| Wooden Furnitures

59 |

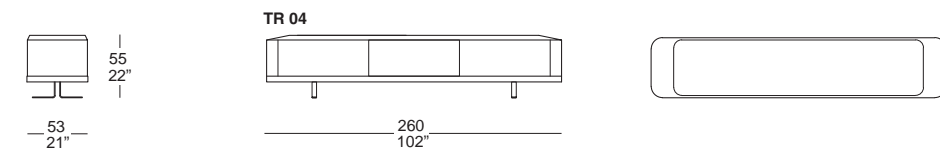
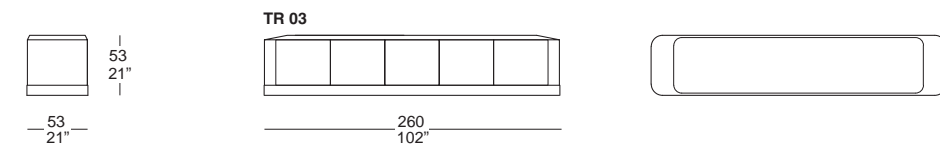
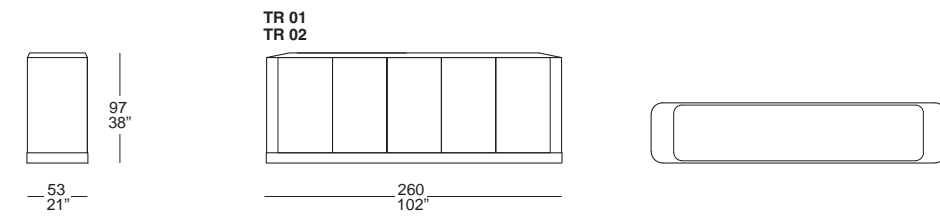
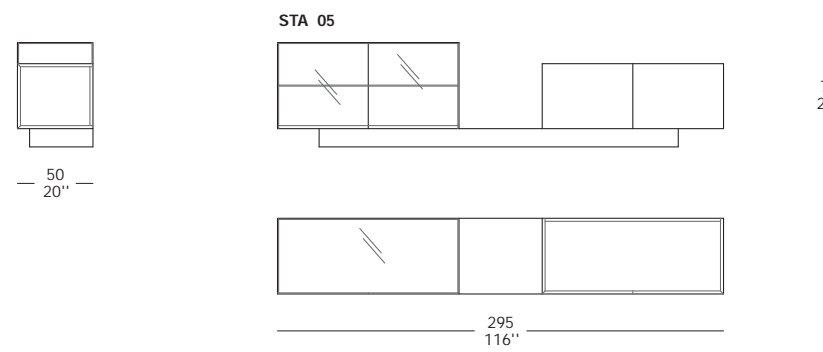
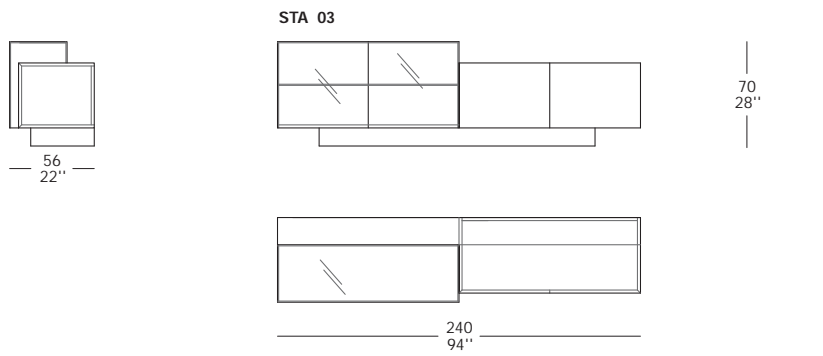
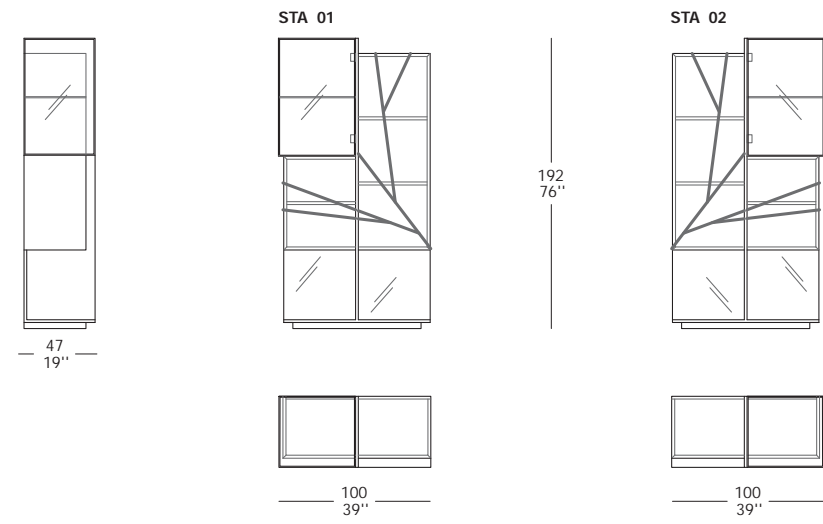

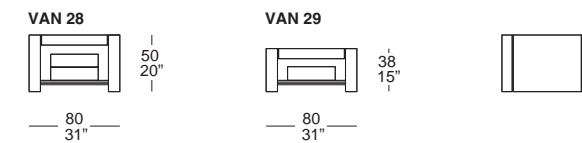
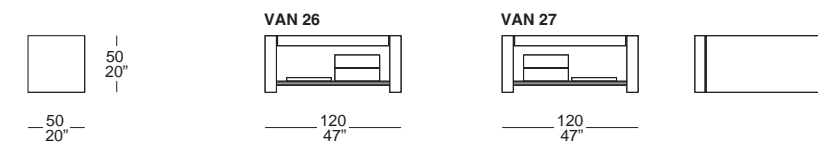
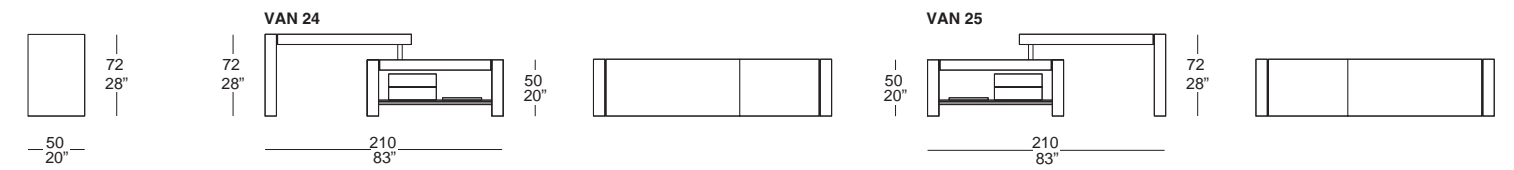
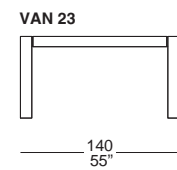
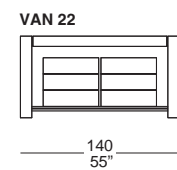
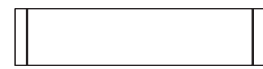
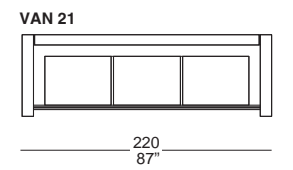
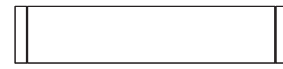
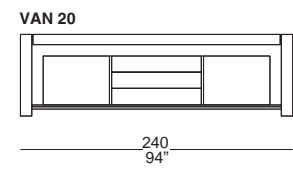
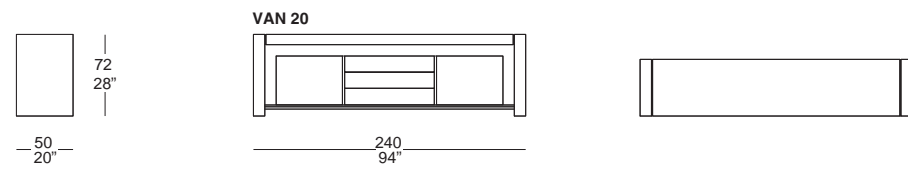

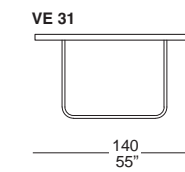
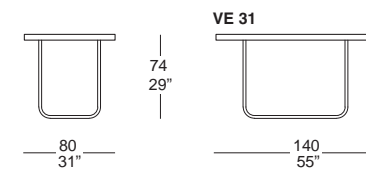
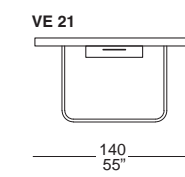
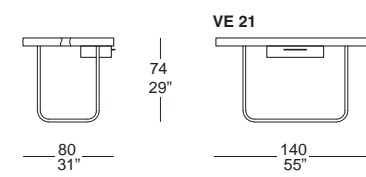
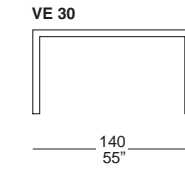
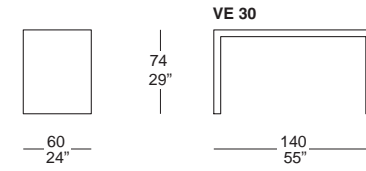
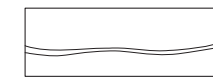
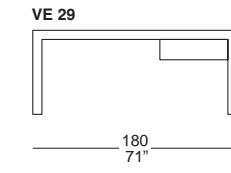
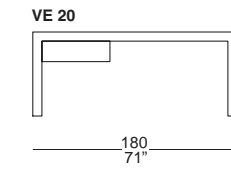
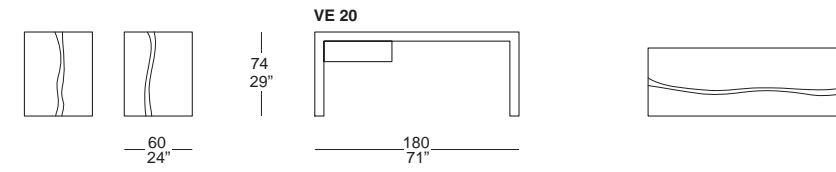
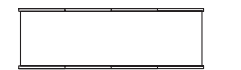
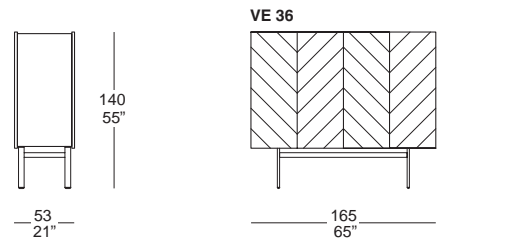
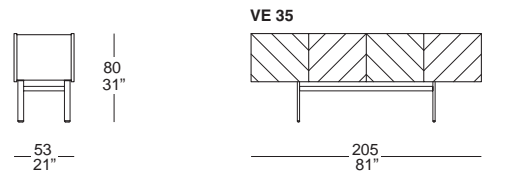
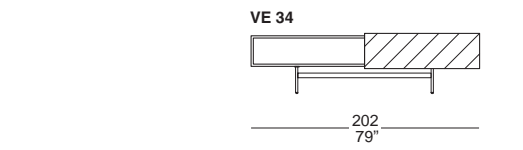
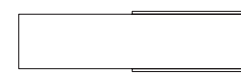
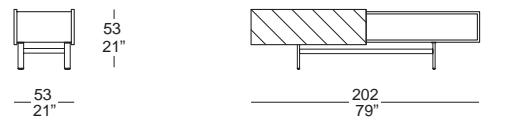
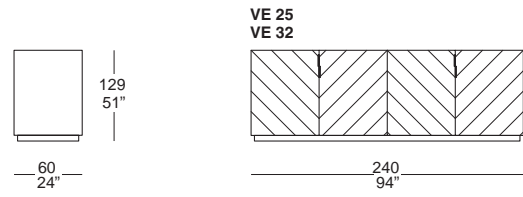

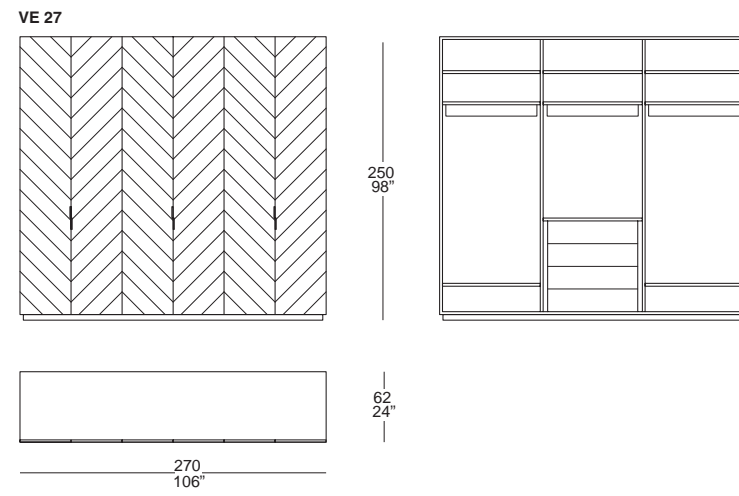
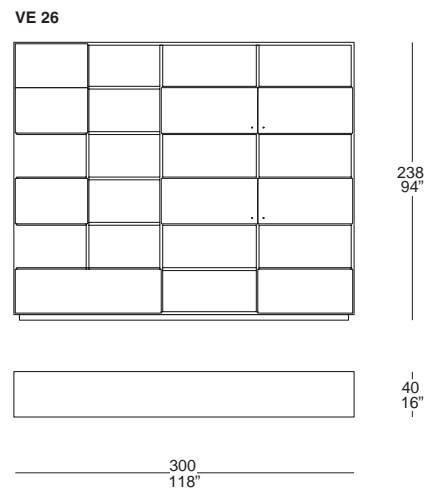
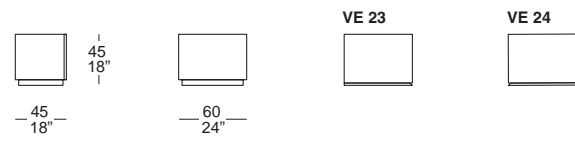
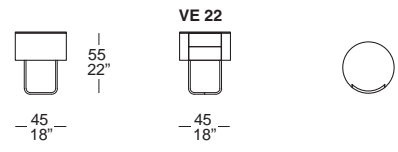

TA 105 "BS"

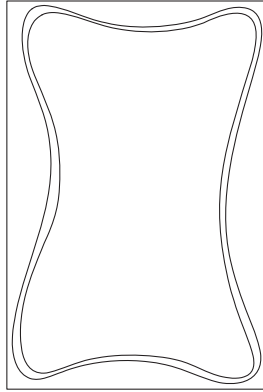

TA 106 "BT"

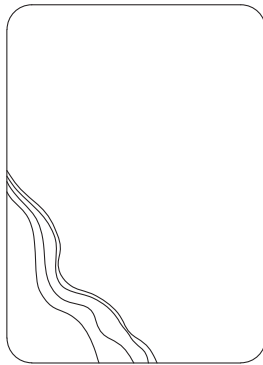

TA 107 "BU"

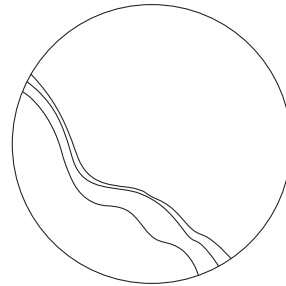

TA 108 "BV"

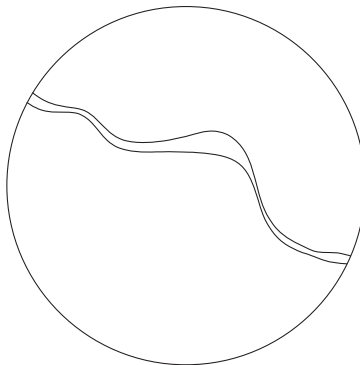

TA 109 "BW"

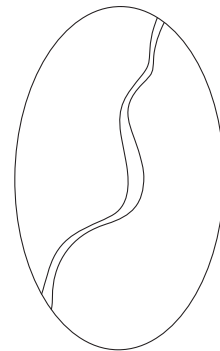



EUROPE
AFRICA
RUSSIAN FEDERATION
MIDDLE EAST
FAR EAST
AUSTRALIA
AMERICA

IL LOFT s.r.l.
Via Pegoraro, 20
21013 Gallarate (Va)
Ph. +39 0331 77.65.78
Fax +39 0331 77.65.79
www.illoft.com
info@illoft.com