

1 ▶

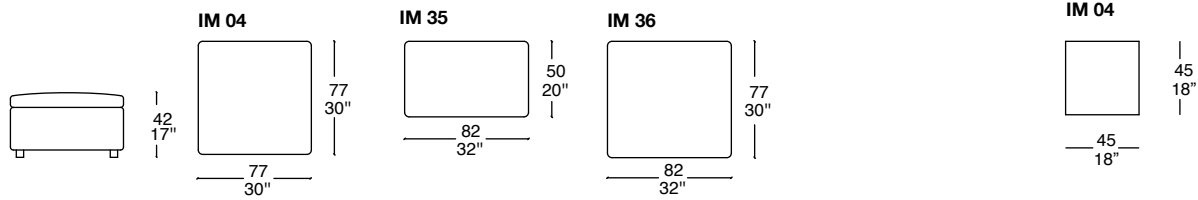

IM 06

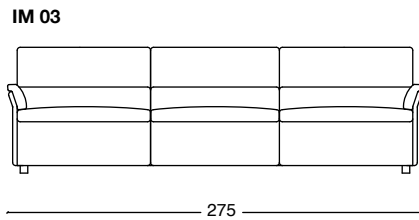
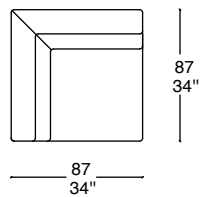

IM 07

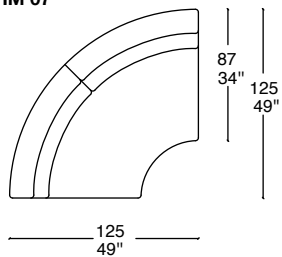

5 ▶

IM 08

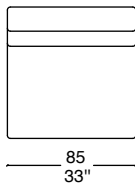

IM 09

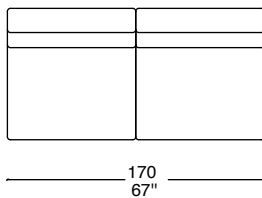

IM 10

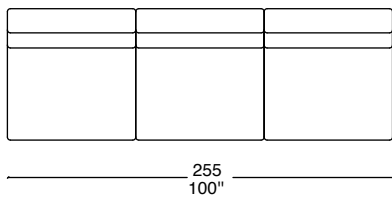

IM 11

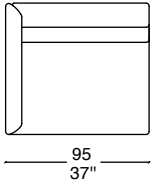

IM 14

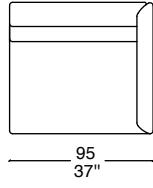

IM 12

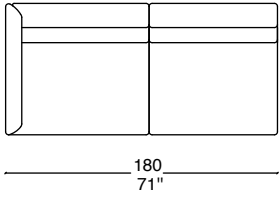

IM 15

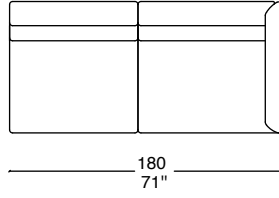

7 ▶

IM 13

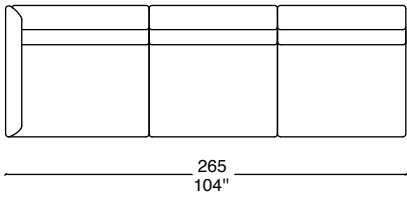

IM 16

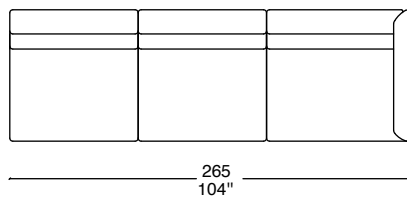

IM 22

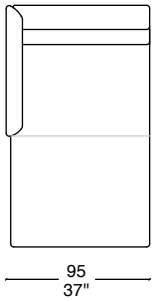

IM 23

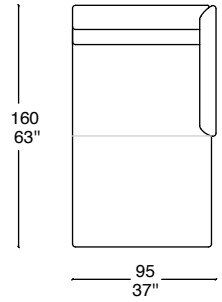

IM 24

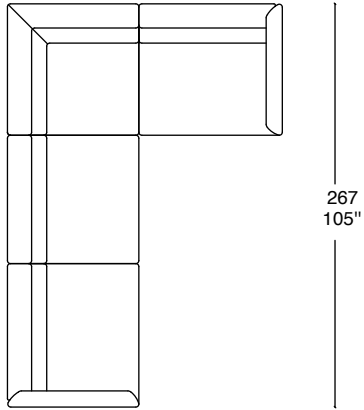

IM 25

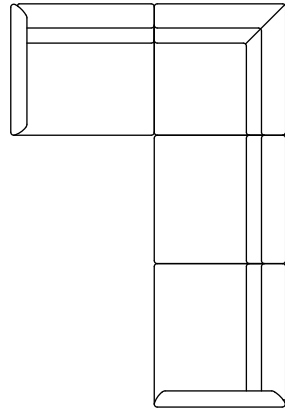

IM 26

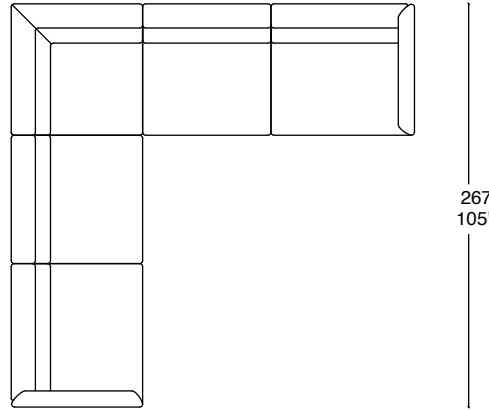

182
72"

182
72"

267
105"

9 ▶

IM 27

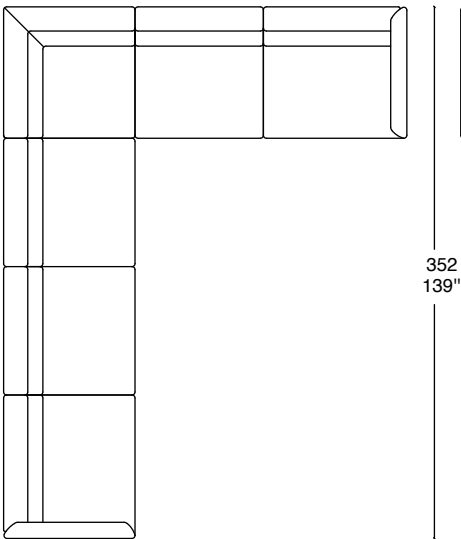

352
139"

267
105"

IM 28

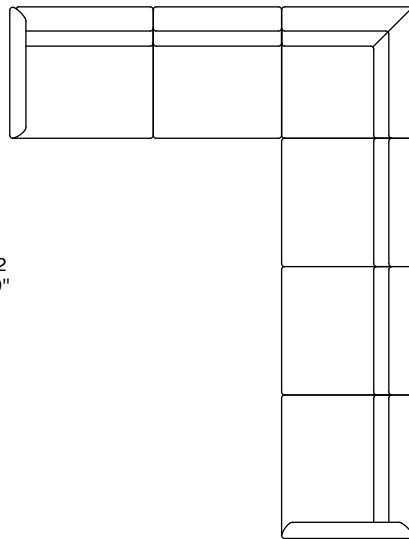

267
105"

IM 29

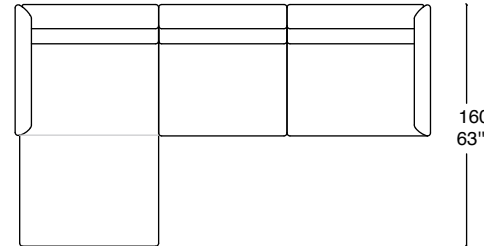

160
63"

275
108"

IM 30

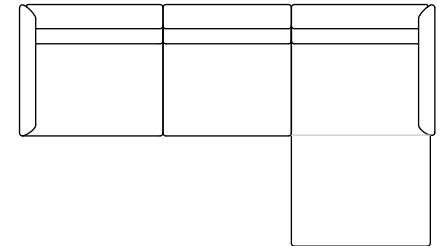

275
108"

IM 20

113
44"

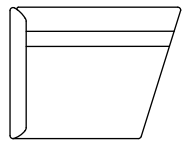

87
34"

IM 18

103
41"

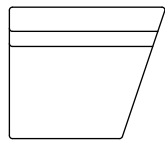

75
29"

IM 17

103
41"

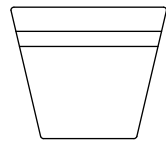

64
25"

IM 19

103
41"

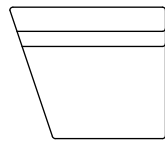

75
29"

IM 21

113
44"

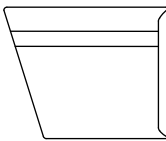

87
34"

IM 31

11 ►

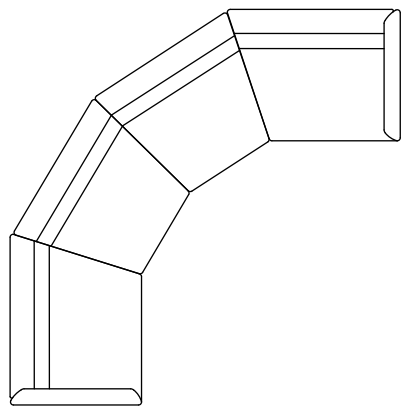

260
102"

260
103"

IM 32

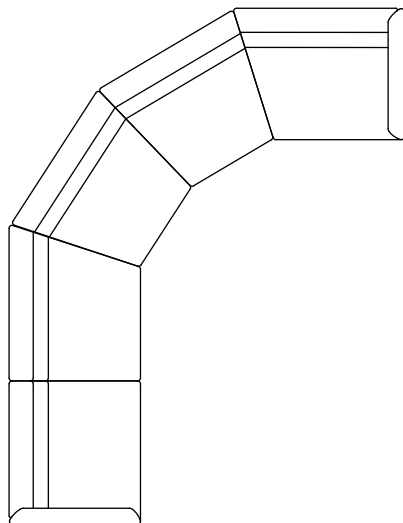

260
103"

IM 33

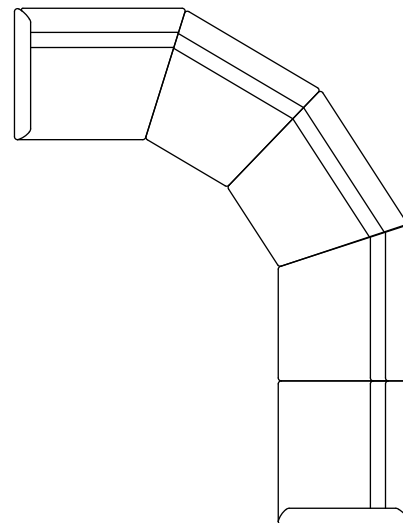

260
103"

345
136"