

PLA 01

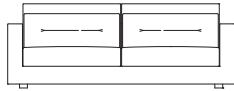

PLA 02

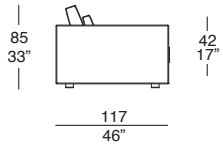
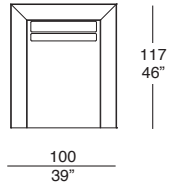
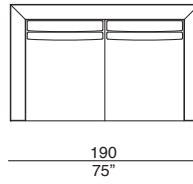

PLA 03

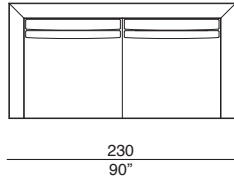

PLA 04

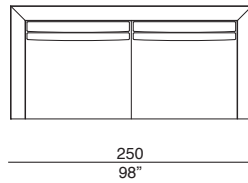

PLA 09

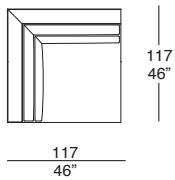

PLA 10



PLA 11



PLA 12

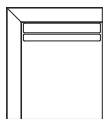

100
39"

PLA 13

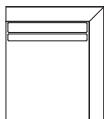

100
39"

PLA 14

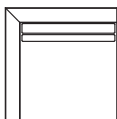

117
46"

PLA 15

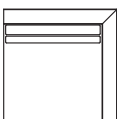

117
46"

PLA 20

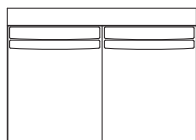

165
65"

2 ▶

PLA 21

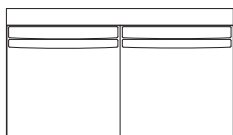

205
81"

PLA 22

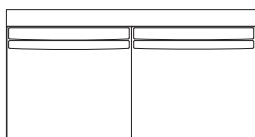

225
89"

PLA 23

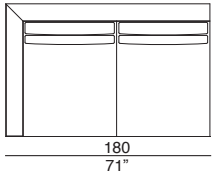

PLA 26

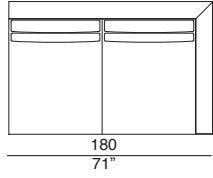

PLA 24

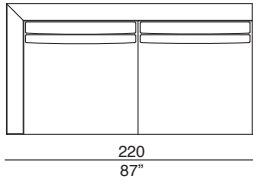

PLA 27

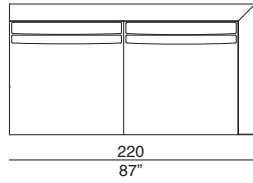

PLA 25

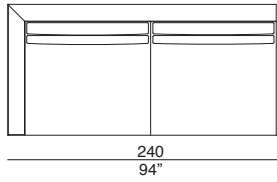

PLA 28

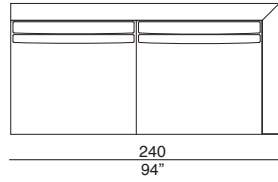

3 ▶

PLA 16

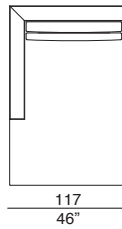

PLA 17

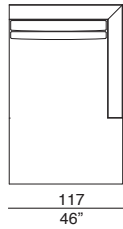

185
73"

PLA 18

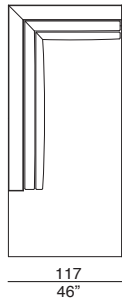

PLA 19

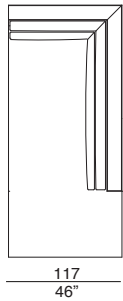

260
102"

PLA 32

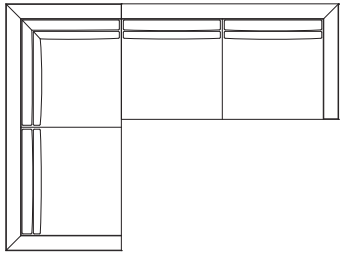

337
132"

PLA 33

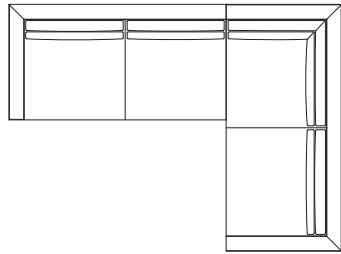

337
132"

250
98"

PLA 34

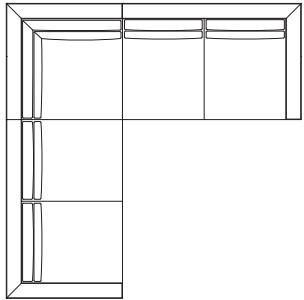

297
117"

297
117"

4 ►

PLA 35

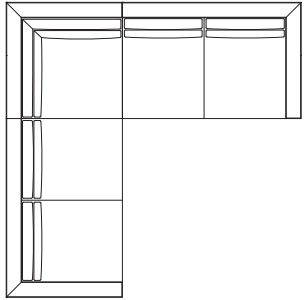

337
133"

337
133"

PLA 36

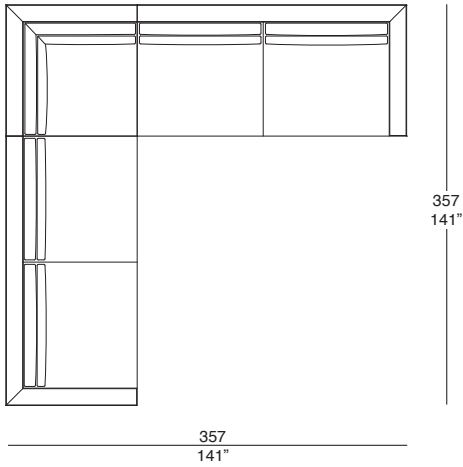

5 ▶

PLA 37

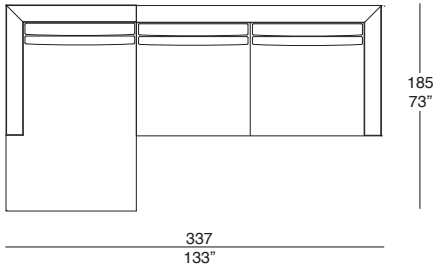

PLA 38

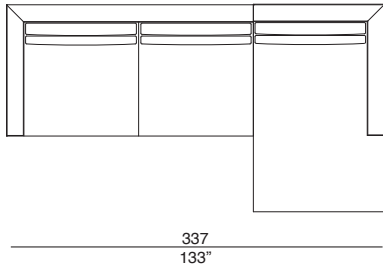

PLA 39

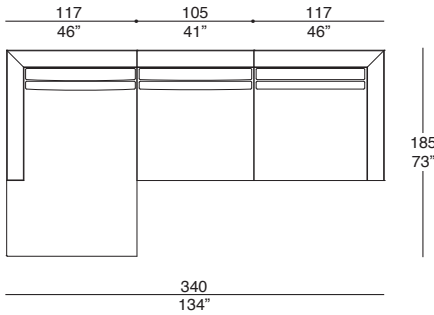

PLA 40

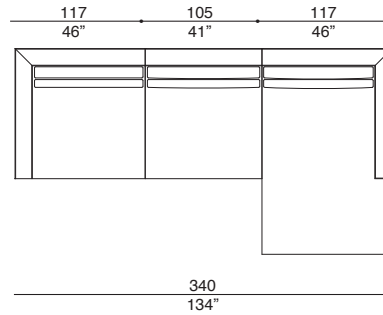

PLA 45

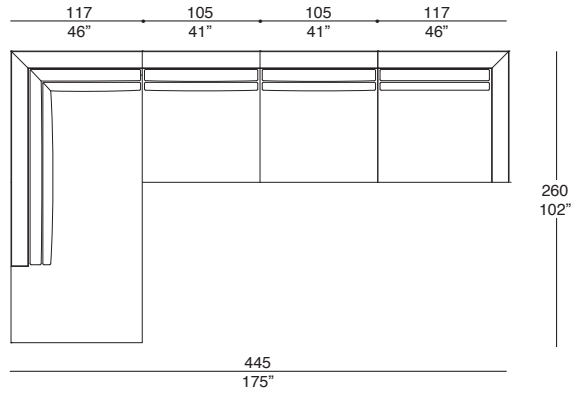

PLA 46

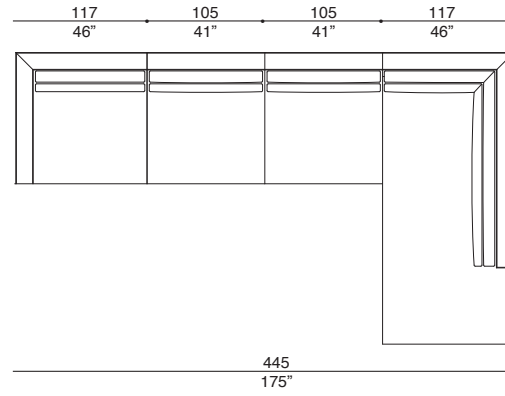

PLA 47

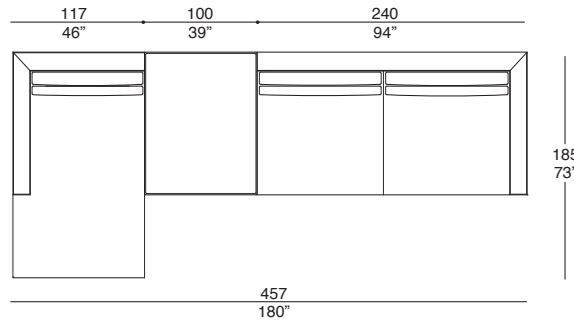

PLA 48

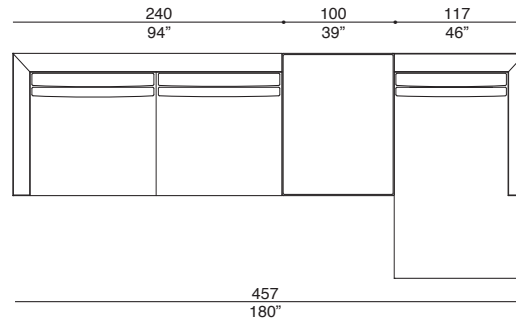

6 ▶

PLA 49

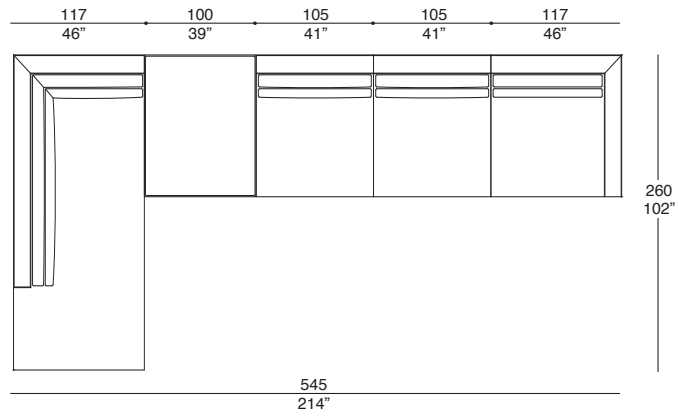

PLA 50

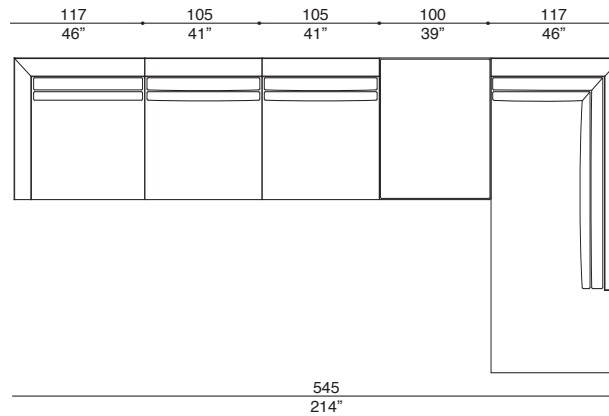

PLA 41

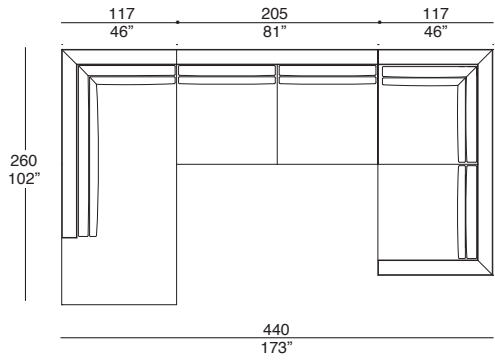

PLA 42

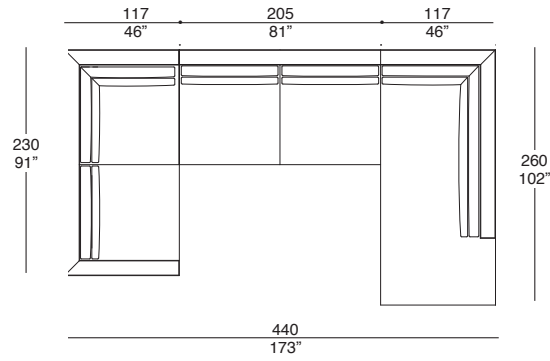

PLA 43

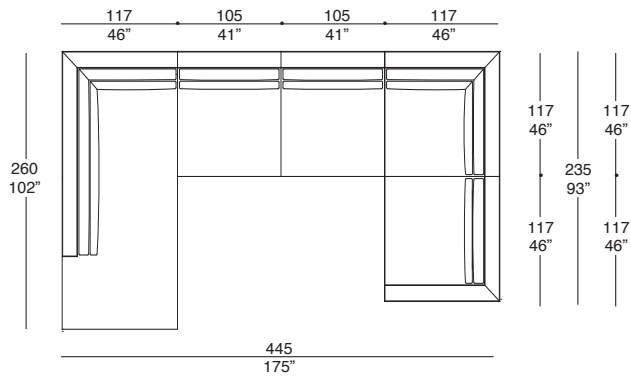

PLA 44

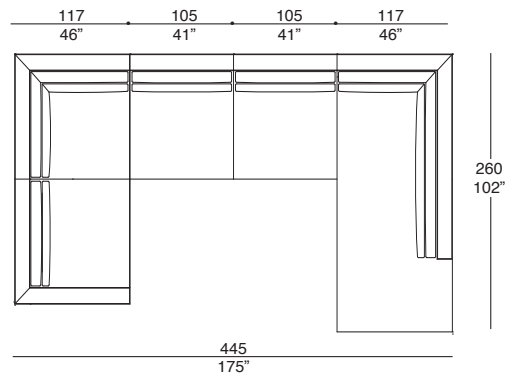

7 ▶

PLA 30



PLA 29



PLA 31

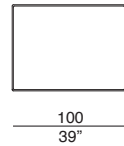

PLA 08

