

AIR 12

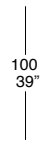

AIR 16

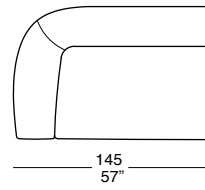
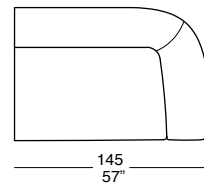

AIR 13

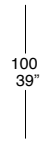
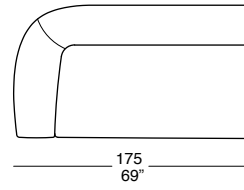

AIR 17

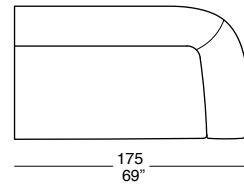

3 ►

AIR 14

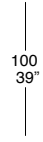
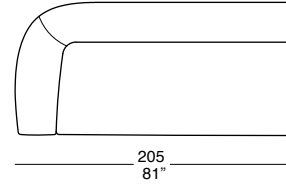

AIR 18

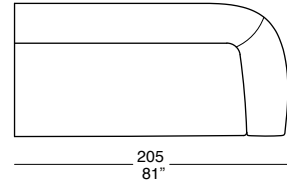

AIR 15

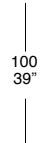
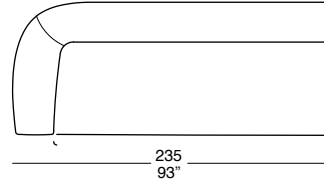

AIR 19

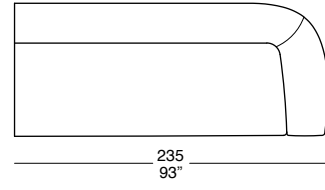

AIR 20

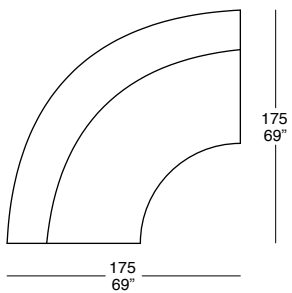

AIR 21

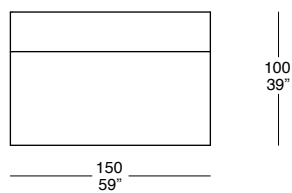

AIR 22

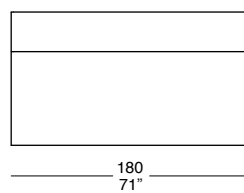

5 ►

AIR 23

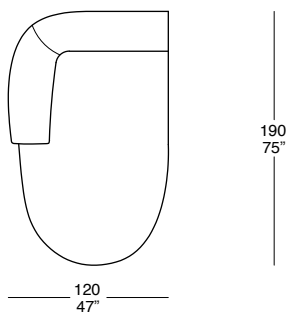

AIR 24

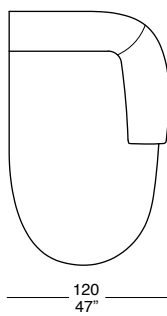

AIR 25

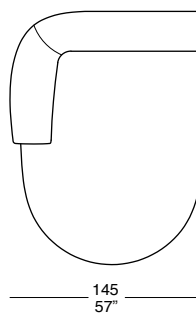

AIR 26

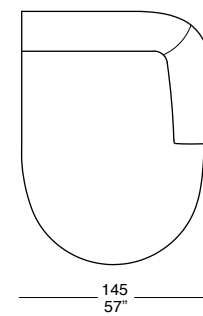

AIR 27

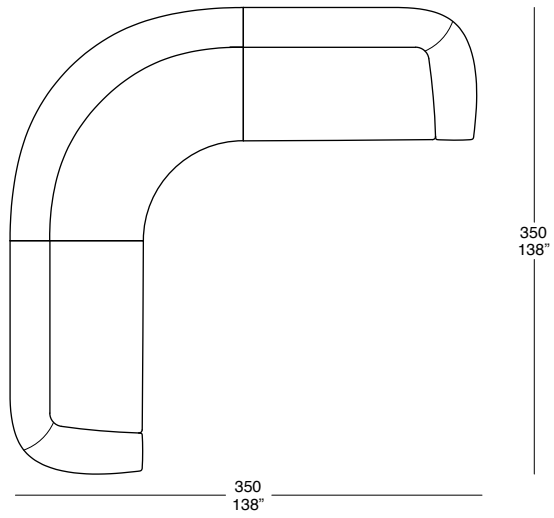

7 ▶

AIR 28

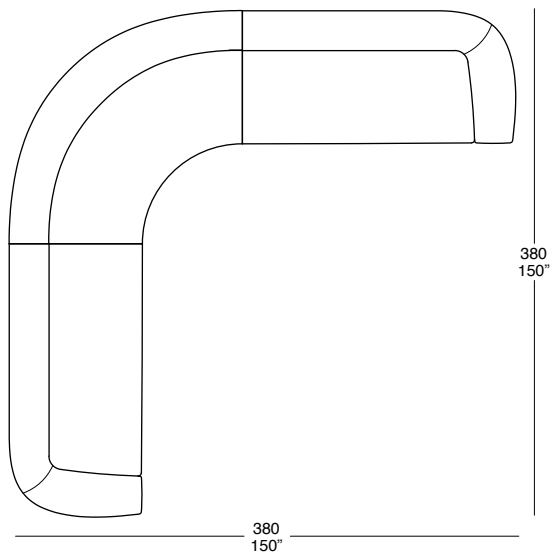

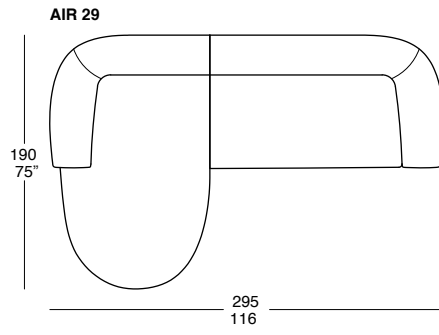

100
39"

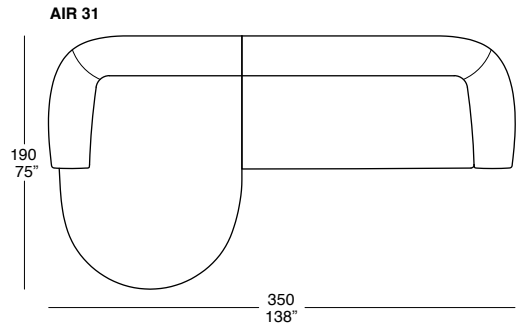
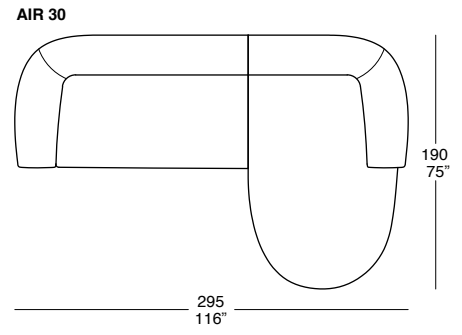

100
39"

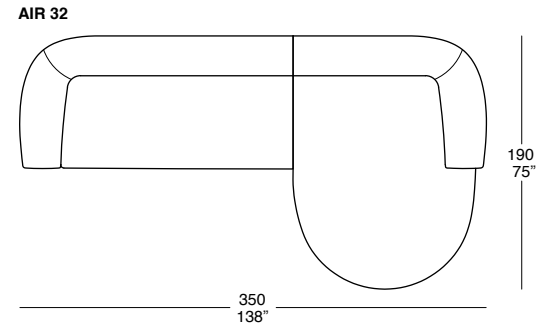

9 ▶

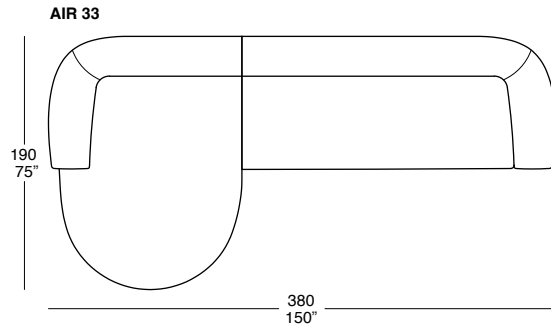

100
39"

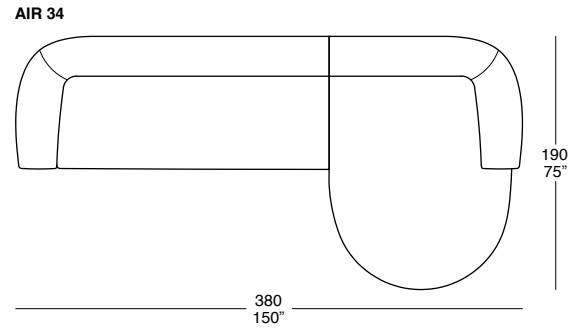

AIR 35

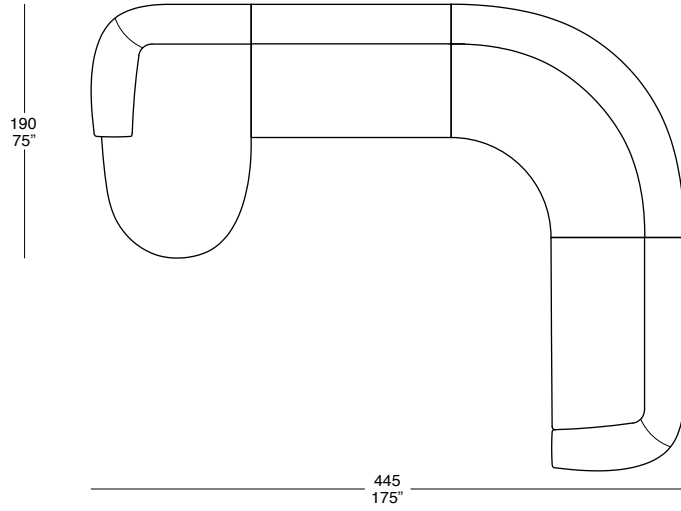

AIR 36

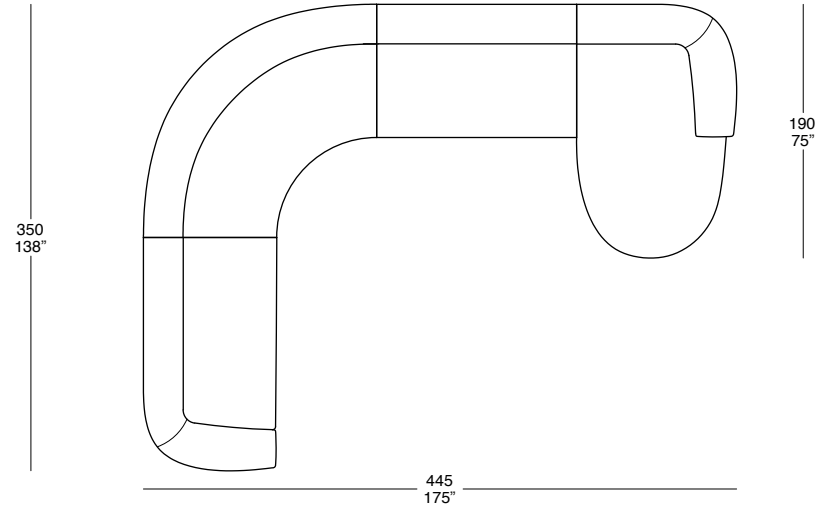

AIR 37

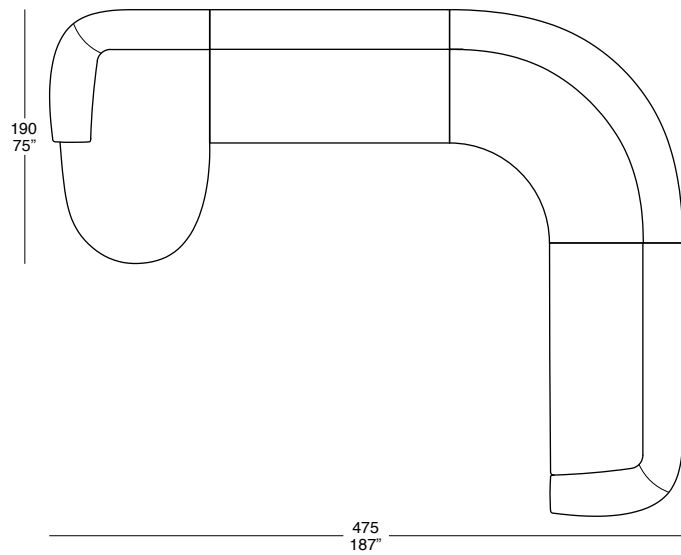

AIR 38

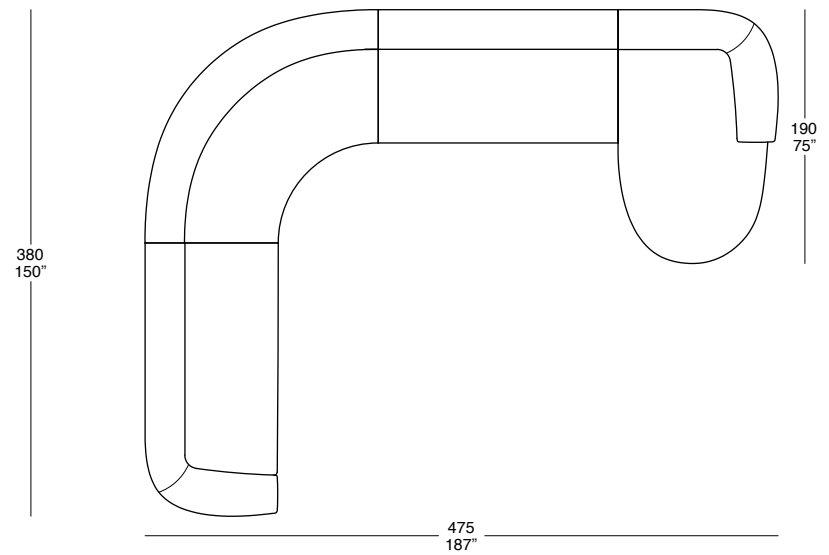

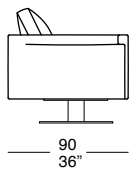

42
17"

90
36"

ANT 01

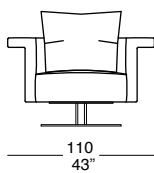

66
26"

110
43"

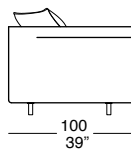

42
17"

100
39"

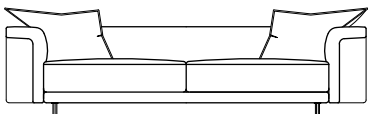

66
26"

ANT 02

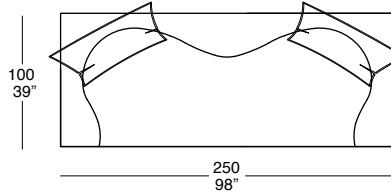

100
39"

250
98"

ANT 03

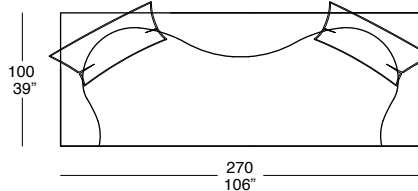

100
39"

270
106"

ANT 04

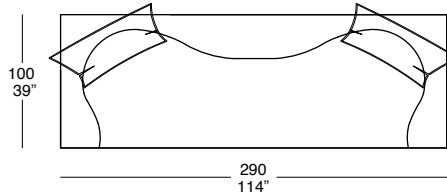

100
39"

290
114"

ANT 05

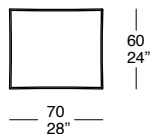

60
24"

70
28"

ANT 06

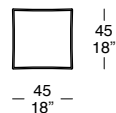

45
18"

45
18"

ANT 07

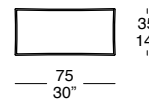

35
14"

75
30"

ANT 08

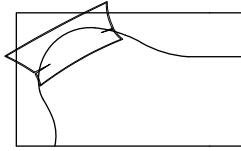

170
67"

100
39"

ANT 11

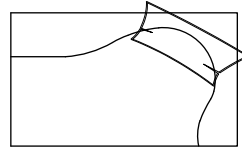

170
67"

ANT 09

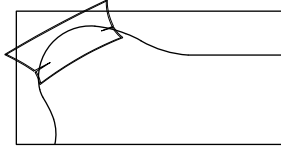

200
79"

100
39"

ANT 12

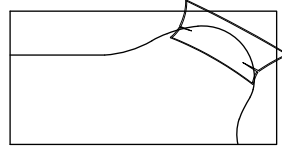

200
79"

3 ►

ANT 10

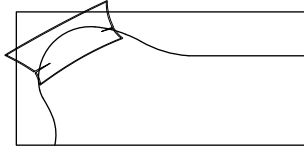

220
87"

100
39"

ANT 13

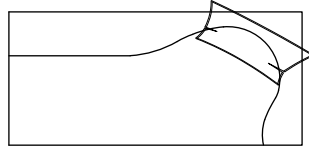

220
87"

ANT 14

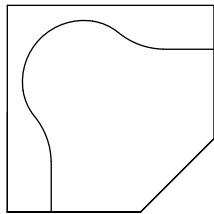

155
61"

155
61"

ANT 15

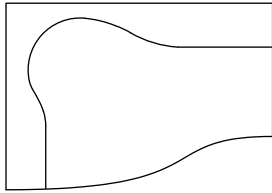

200
79"

ANT 16

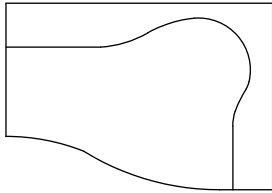

200
79"

140
55"

5 ►

ANT 17

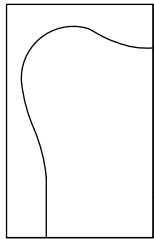

110
43"

ANT 18

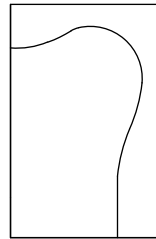

110
43"

175
69"

ANT 19

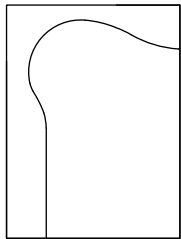

130
51"

ANT 20

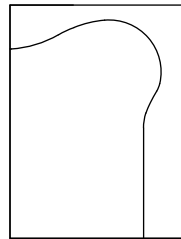

130
51"

175
69"

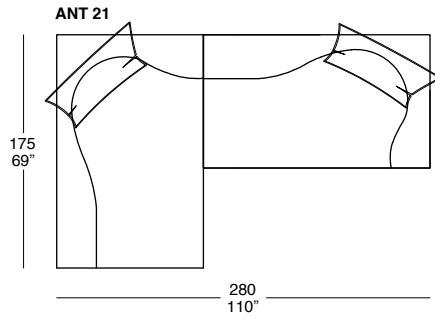

100
39"

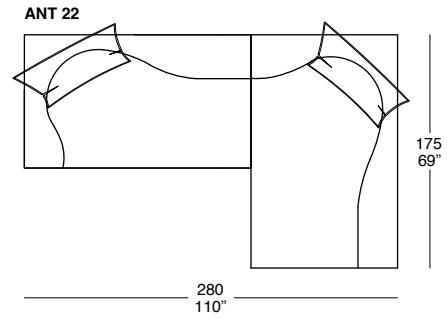

7 ▶

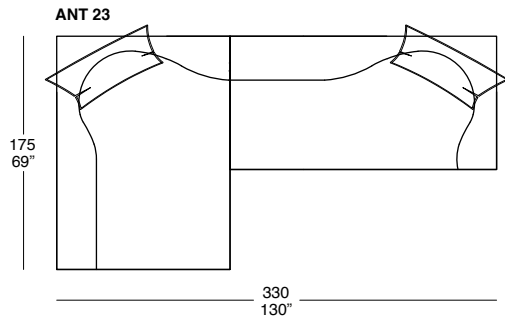

100
39"

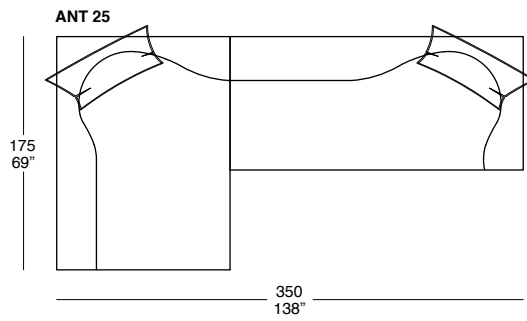
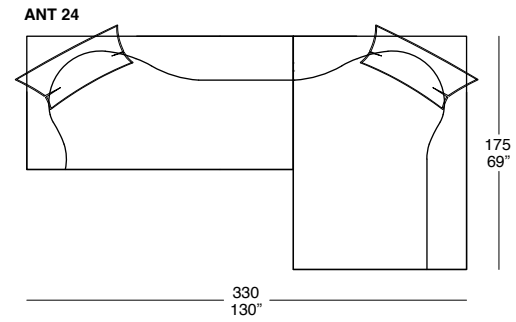

100
39"

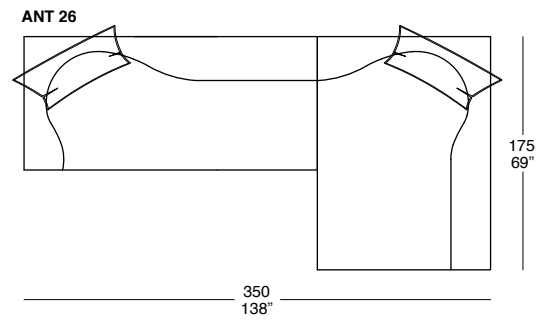

ANT 27

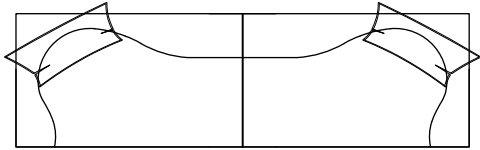

340
134"

100
39"

ANT 28

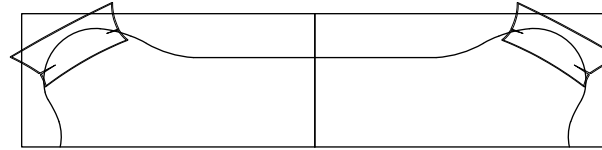

440
173"

ANT 29

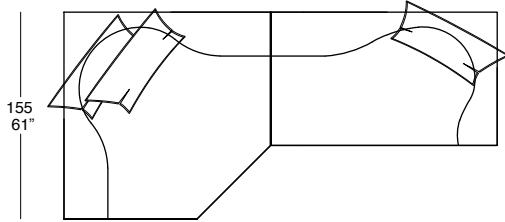

155
61"

325
128"

100
39"

ANT 30

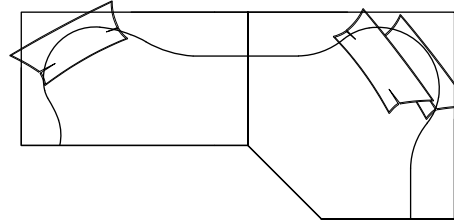

155
61"

325
128"

ANT 31

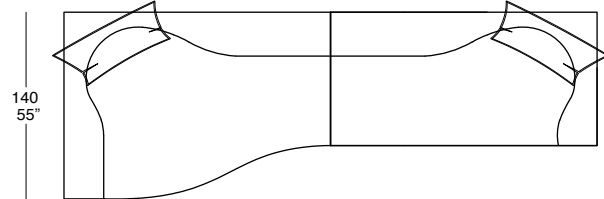

140
55"

400
157"

100
39"

ANT 32

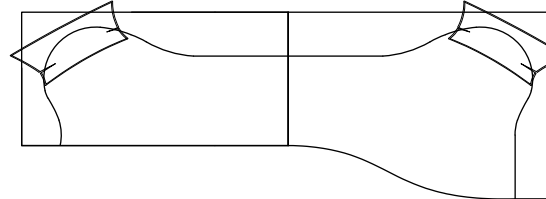

140
55"

400
157"

ANT 33

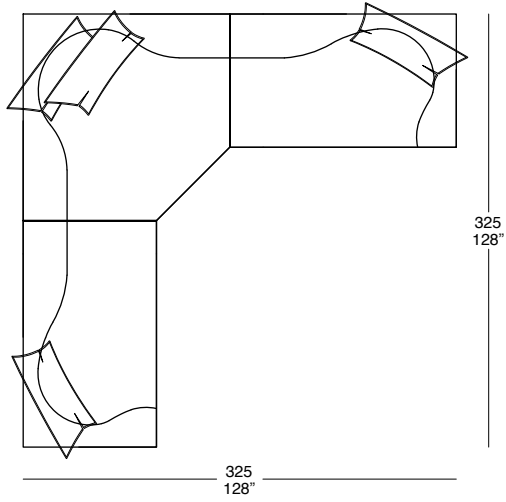

ANT 34

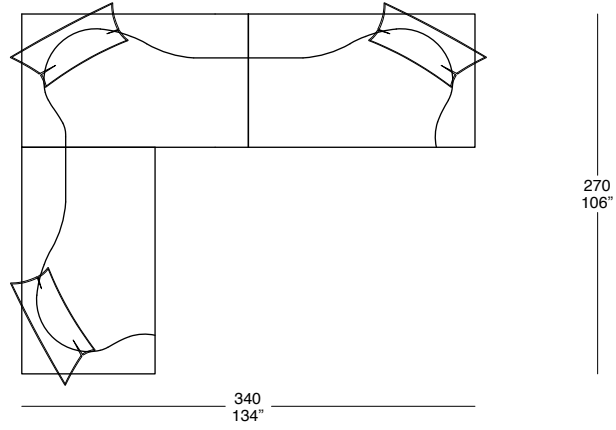

ANT 35

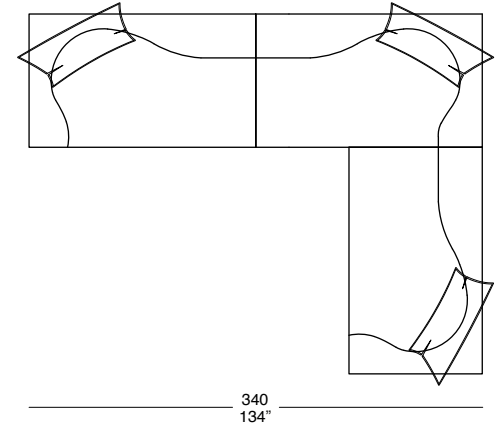

ANT 36

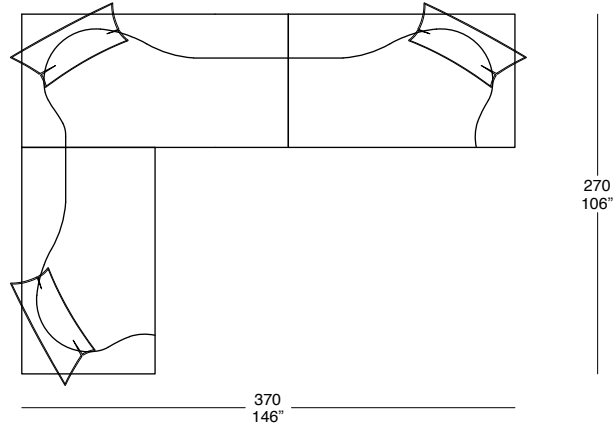

ANT 37

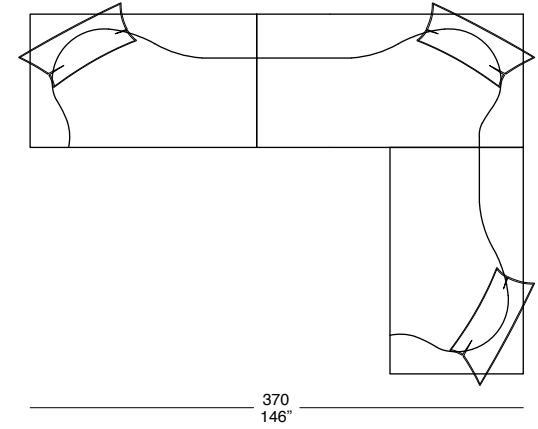

ANT 38

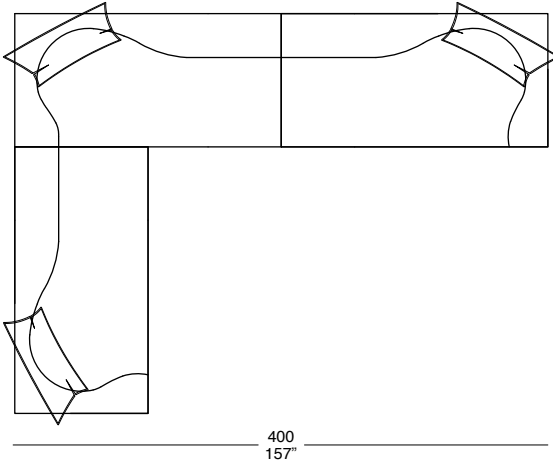

ANT 39

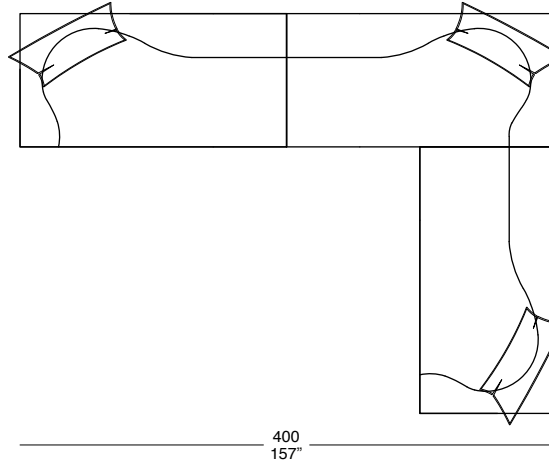

ANT 40

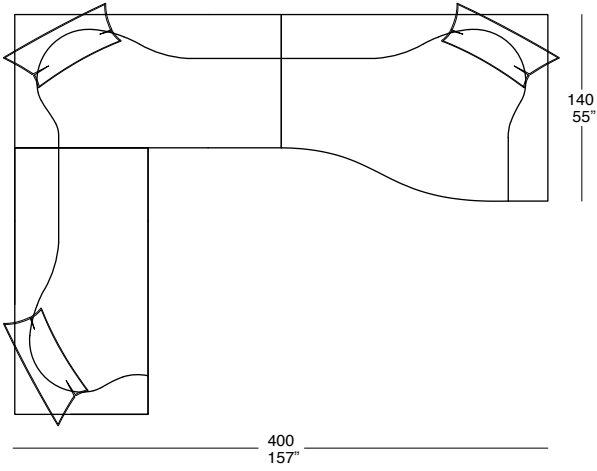

ANT 41

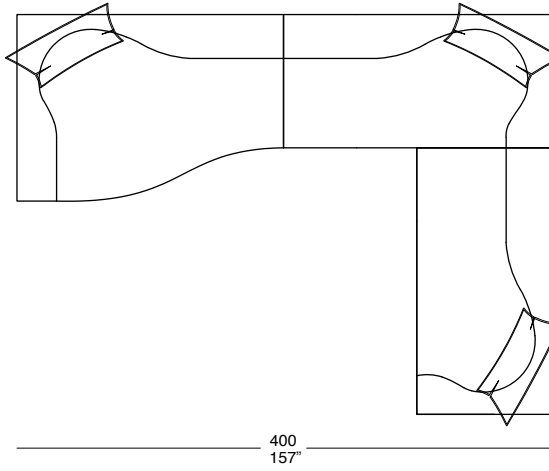

ANT 42

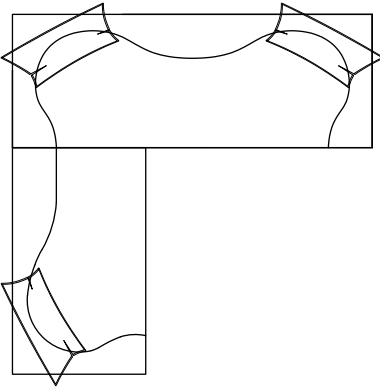

270
106"

270
106"

15 ►

ANT 43

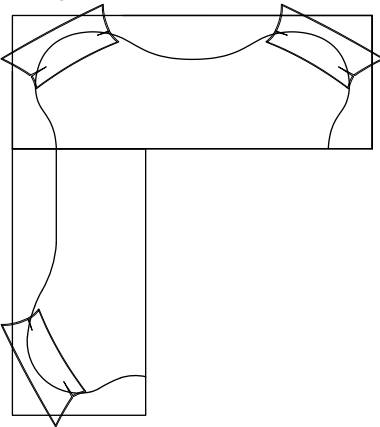

300
118"

270
106"

ANT 44

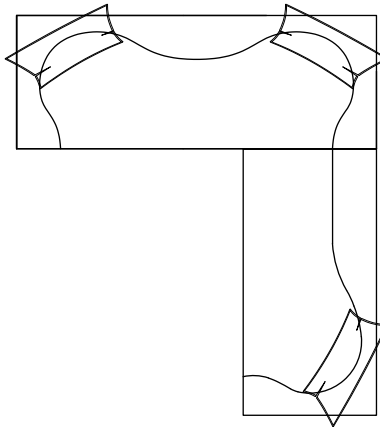

270
106"

BALDWIN

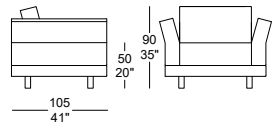

BW 01



BW 02

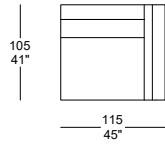

BW 03

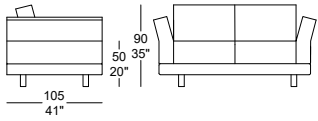
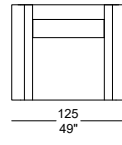

BW 04

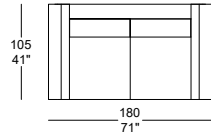

BW 05

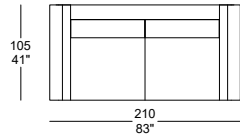

BW 06

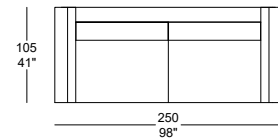

BW 07

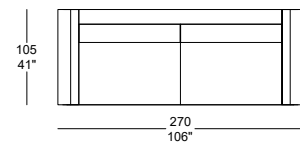

BW 08

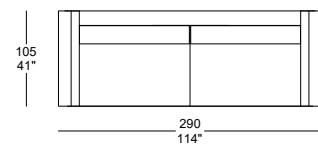

BALDWIN

BW 09

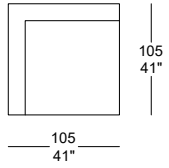

BW 10

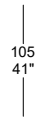
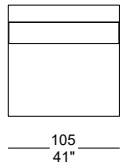

BW 11

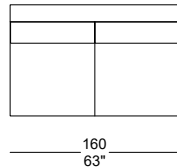

2 ▶

BW 12

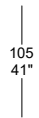
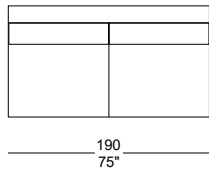

BW 13

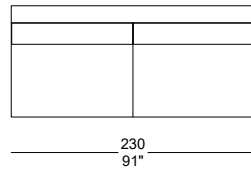

BW 14

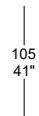
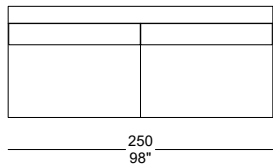

BW 15

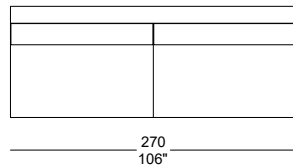

BALDWIN

BW 16

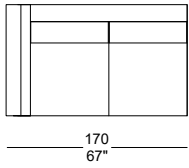

105
41"

BW 21

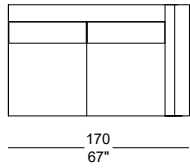

BW 17

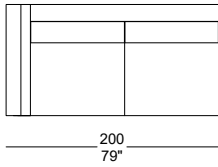

105
41"

BW 22

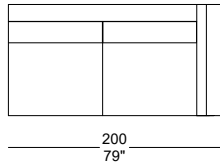

3 ▶

BW 18

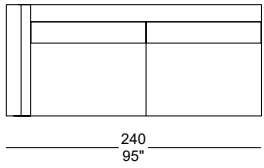

105
41"

BW 23

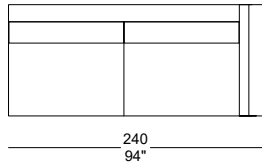

BW 19

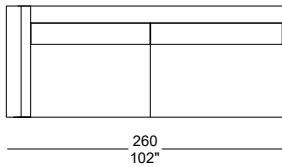

105
41"

BW 24

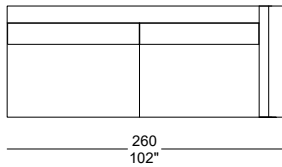

BW 20

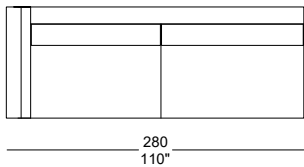

105
41"

BW 25

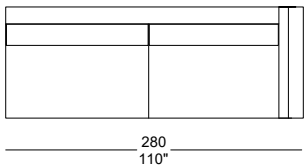

BALDWIN

BW 26

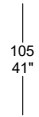
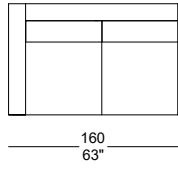

BW 31

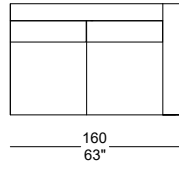

BW 27

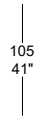
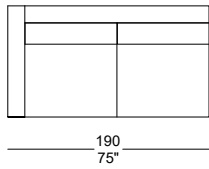

BW 32

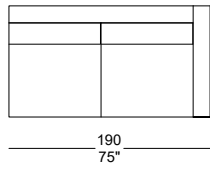

BW 28

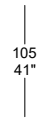
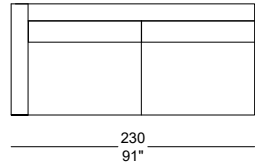

BW 33

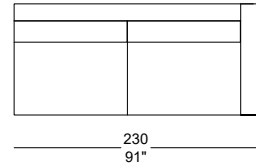

BW 29

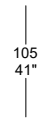
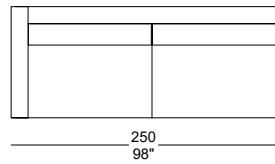

BW 34

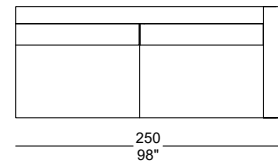

BW 30

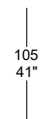
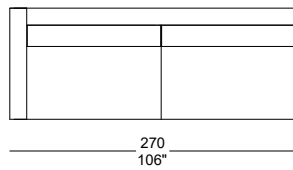

BW 35

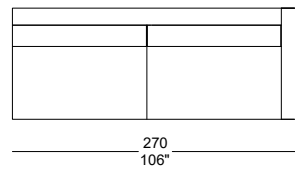

BALDWIN CHAISE LONGUE

BW 36

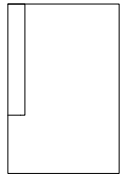

105
41"

BW 37

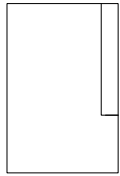

105
41"

160
63"

BW 40

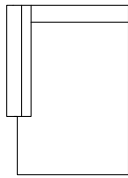

115
45"

BW 41

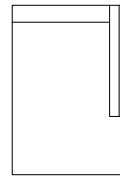

115
45"

160
63"

5 ▶

BW 38

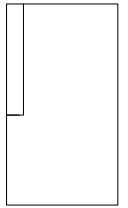

105
41"

BW 39

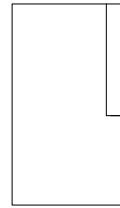

105
41"

190
75"

BW 42

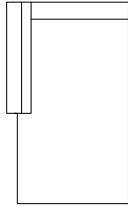

115
45"

BW 43

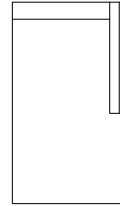

115
45"

190
75"

BALDWIN

BW 44

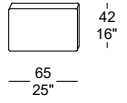

BW 45

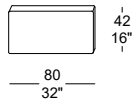

BW 46

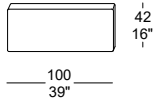

BW 47

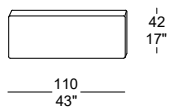

BW 48

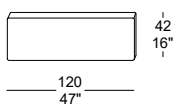

6 ▶

BW 49

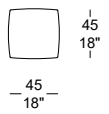

BW 50

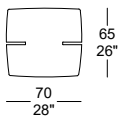

BALDWIN

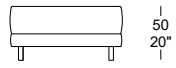

BW 51

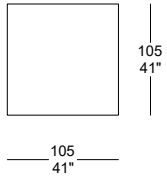

BW 52

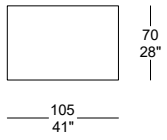

BW 53

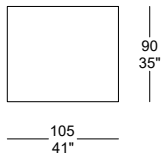

BALDWIN

BW 62

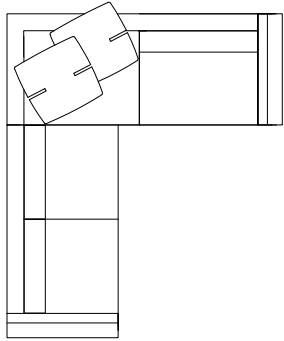

260
102"

305
120"

BW 63

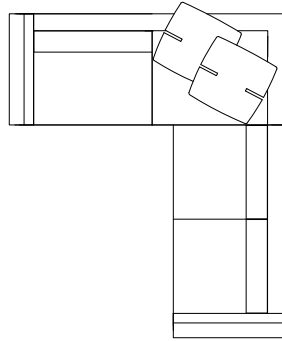

260
102"

8 ▶

BW 64

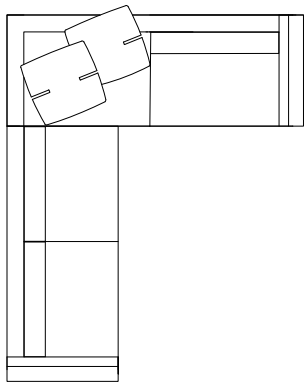

280
110"

345
136"

BW 65

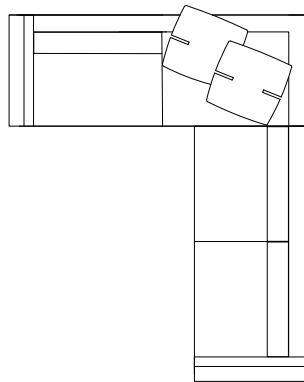

280
110"

BALDWIN

BW 66

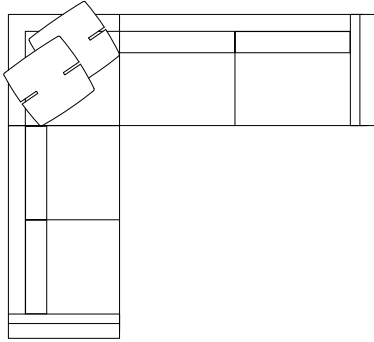

305
120"

345
136"

BW 67

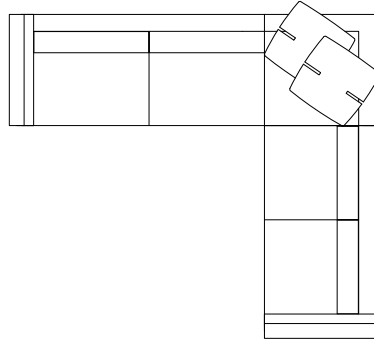

345
136"

9 ▶

BW 68

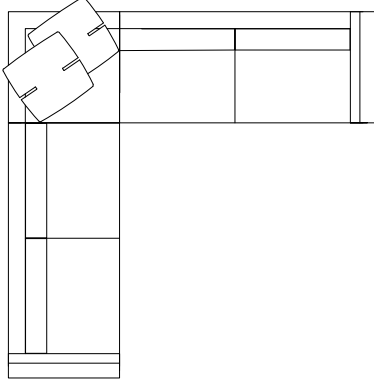

345
136"

345
136"

BALDWIN

BW 69

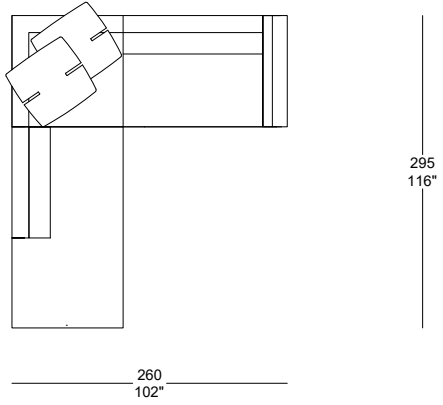

BW 70

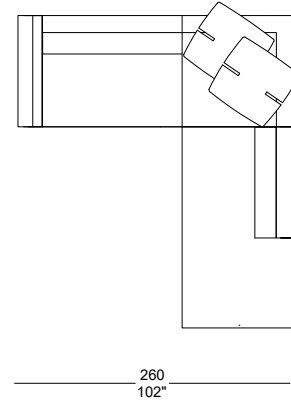

10 ▶

BW 71

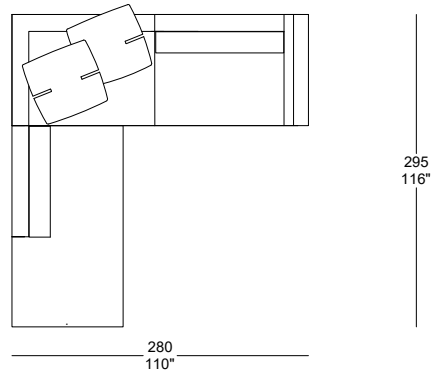

BW 72

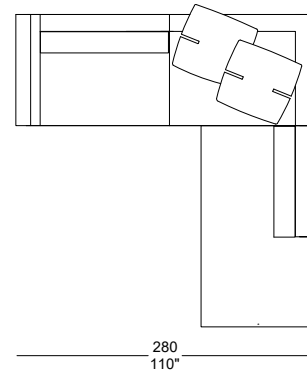

BALDWIN

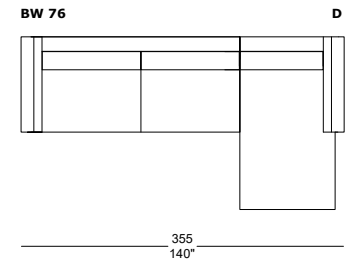
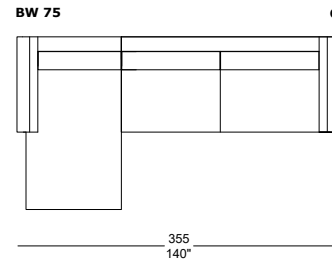
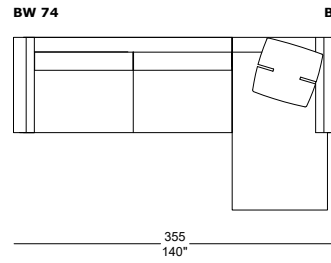
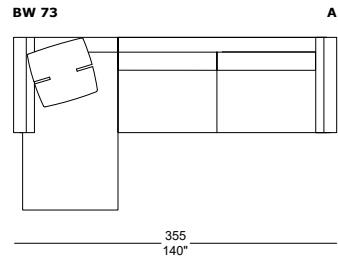

11 ▶

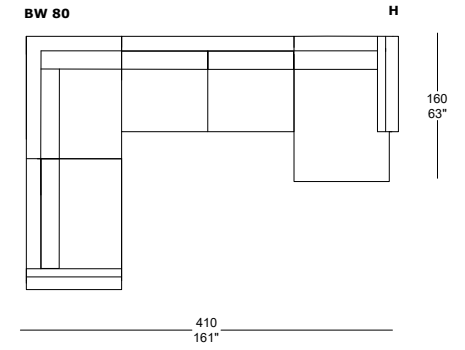
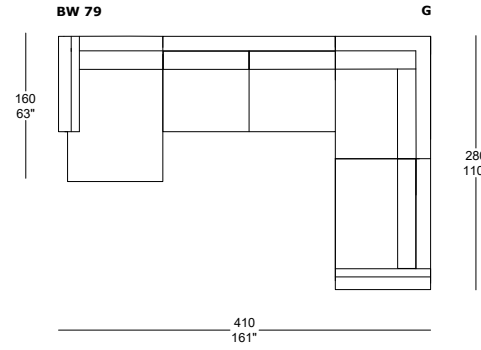
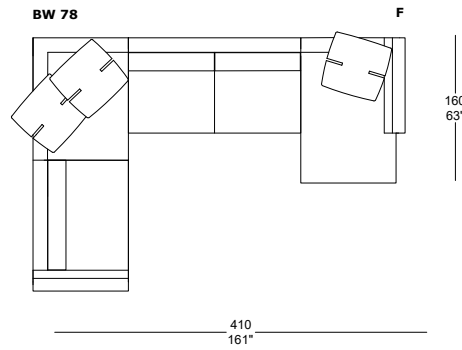
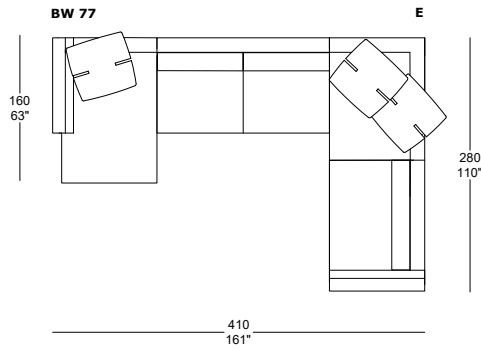

BALDWIN

BW 81

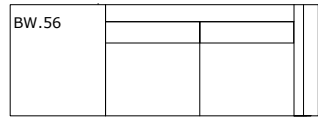

105
41"

290
114"

BW 82

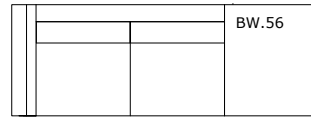

290
114"

12 ▶

BW 83

I

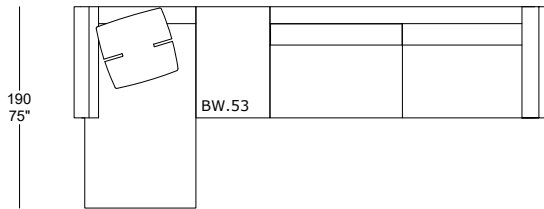

105
41"

445
175"

190
75"

BW 84

L

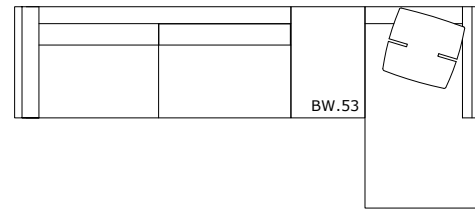

190
75"

445
175"

BW 85

M

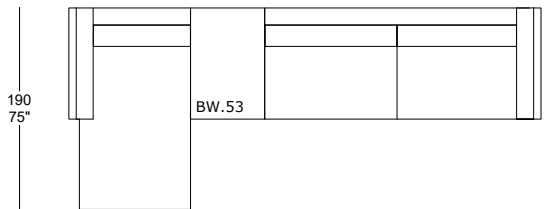

105
41"

445
175"

190
75"

BW 86

N

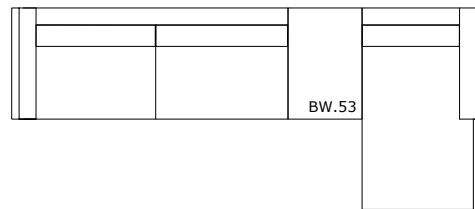

190
75"

445
175"

BALDWIN

BW 87

O

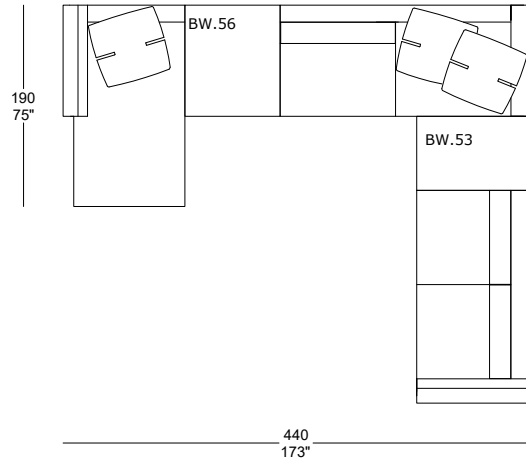

BW 88

P

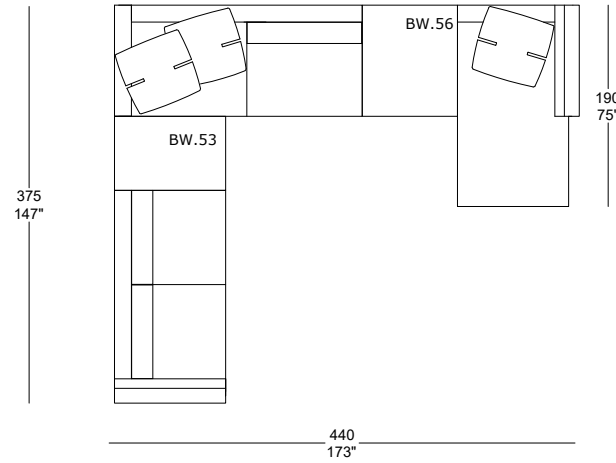

13 ▶

BW 89

Q

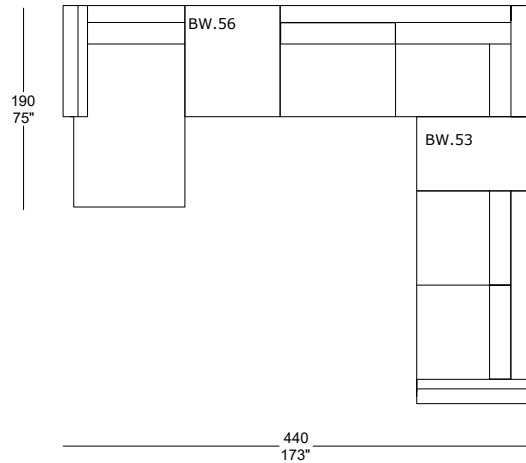

BW 90

R

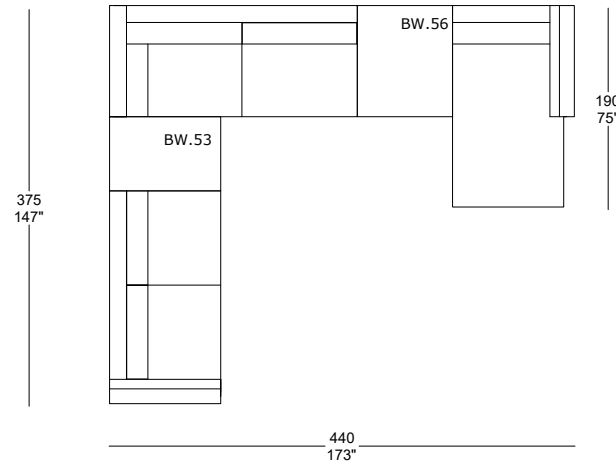

BALDWIN

BW 91

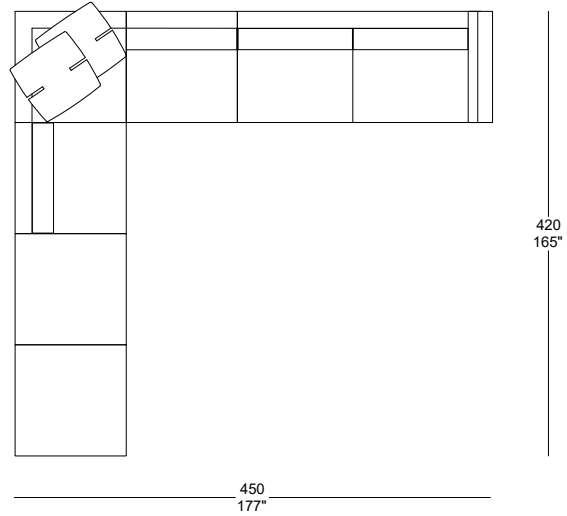

14 ▶

BW 92

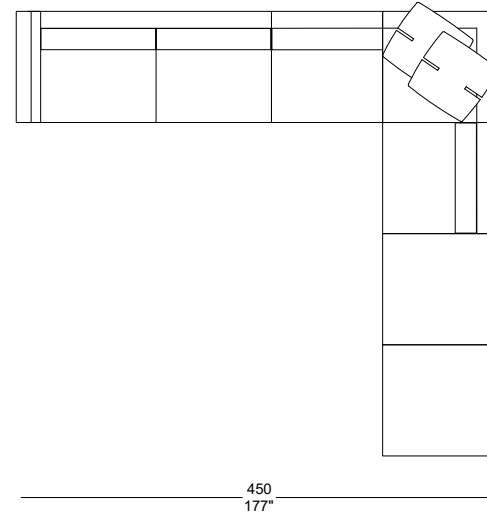

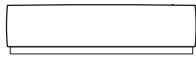

CUB 02



CUB 04



CUB 06

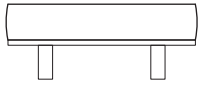

| 42
| 17"

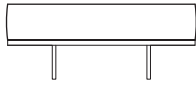

CUB 01

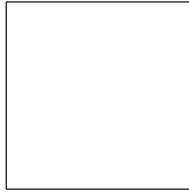

105
41"

105
41"

CUB 03



105
41"

180
71"

CUB 05



105
41"

200
79"

1 ▶

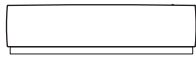

CUB 08



CUB 10

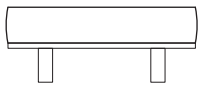

| 42
| 17"



CUB 07



105
41"

230
91"

CUB 09



105
41"

250
98"

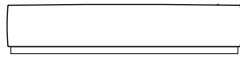

CUB 12



CUB 14



CUB 16



CUB 11

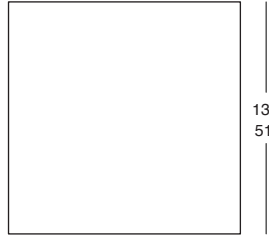

130
51"

130
51"

CUB 13

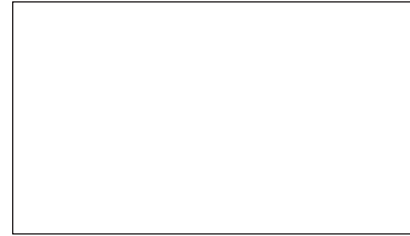

130
51"

230
91"

CUB 15

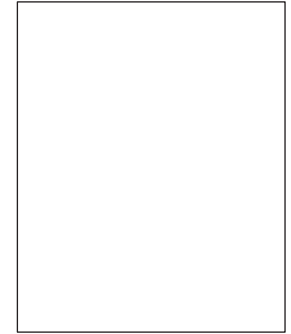

185
73"

150
59"

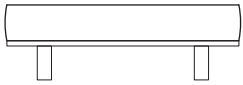

42
17"

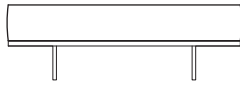

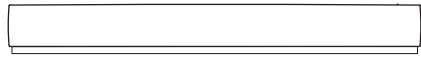

CUB 18



CUB 20

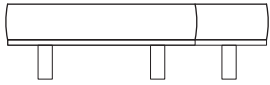

42
17"

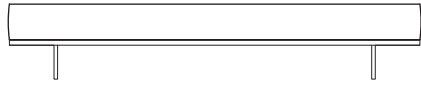

CUB 17

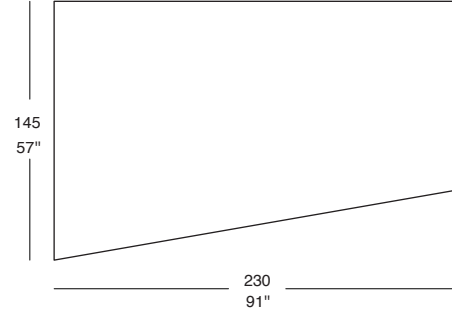

CUB 19

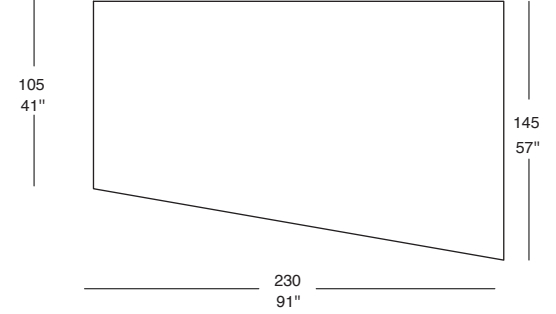

3 ▶

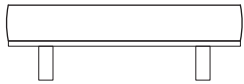

42
17"

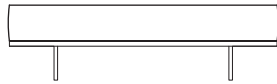

CUB 21

POUFF

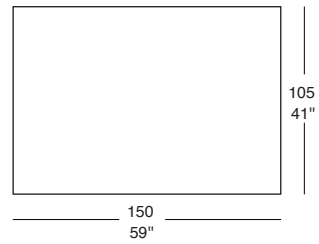

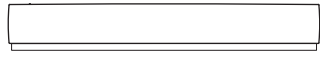

CUB 24



CUB 22

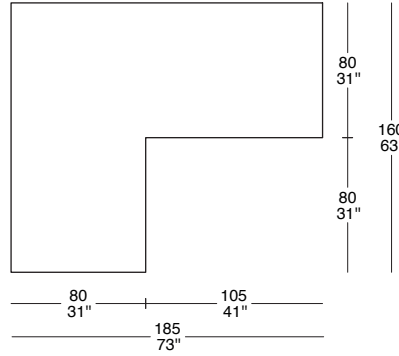

CUB 23

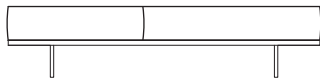
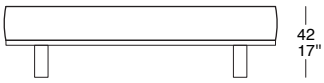
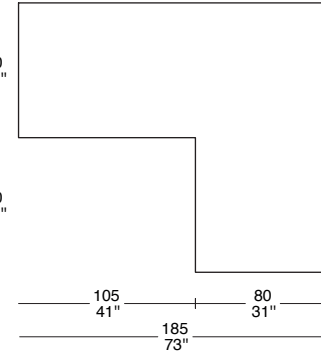

4 ▶

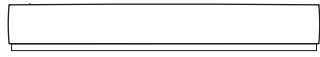

CUB 27



CUB 25

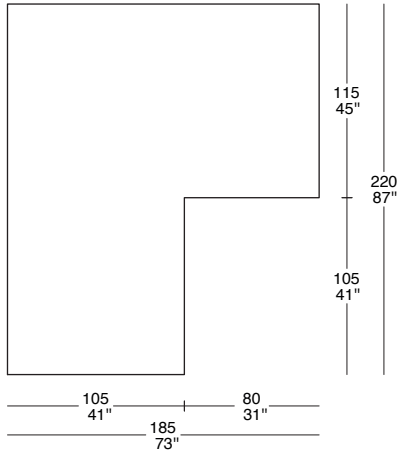

CUB 26

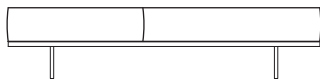
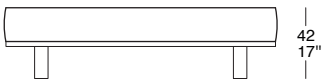
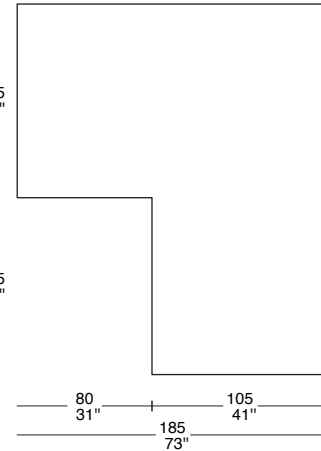

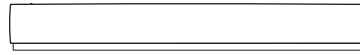

CUB 30

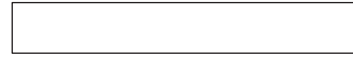

CUB 28

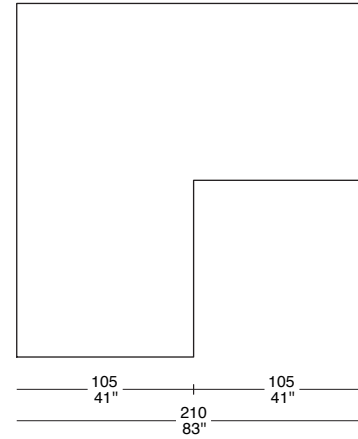

CUB 29

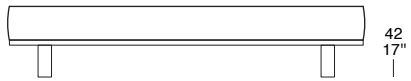
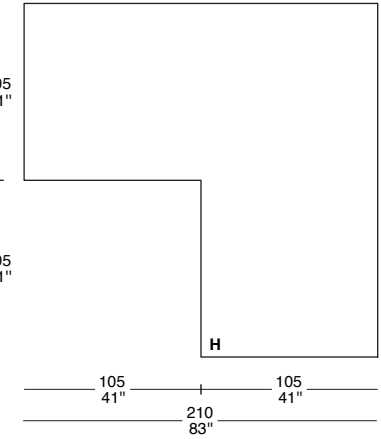

42
17"

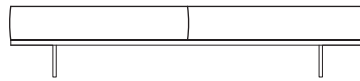

CUB 32



CUB 31

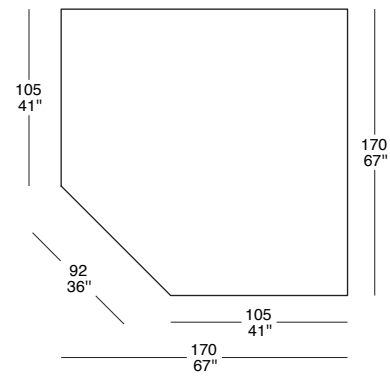

CUSCINI SCHIENALI / BACK CUSHIONS

CUB 33

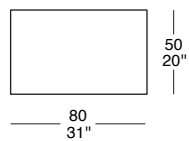

CUB 34

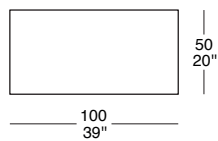

CUB 35

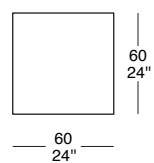

CUB 36

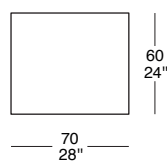

CUB 37

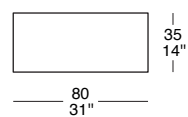

CUB 38

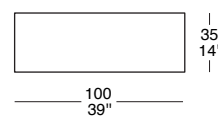

CUSCINO / CUSHION

CUB 39

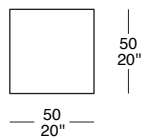

6 ▶

BRACCIOLO / ARM

CUB 91

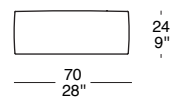
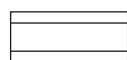

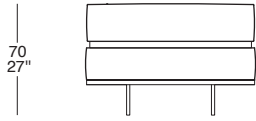
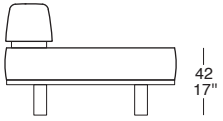

CUB 40

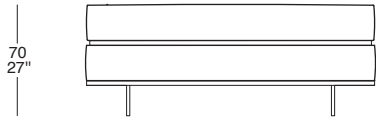
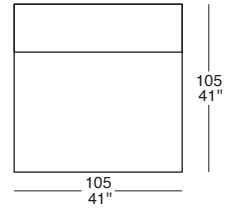

CUB 41

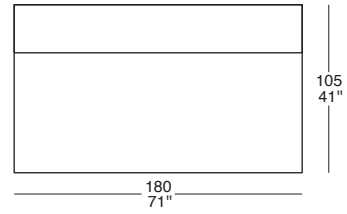

7 ▶

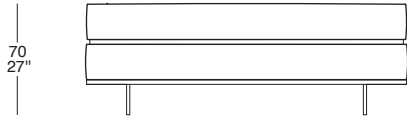

CUB 42

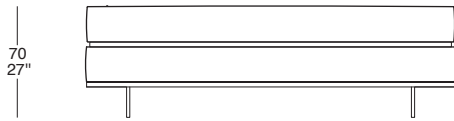
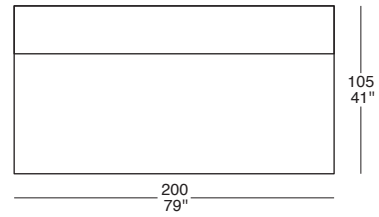

CUB 43

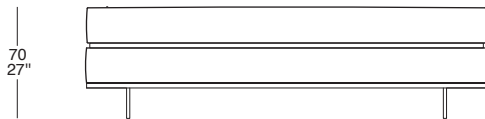
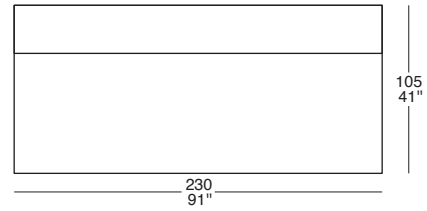

CUB 44

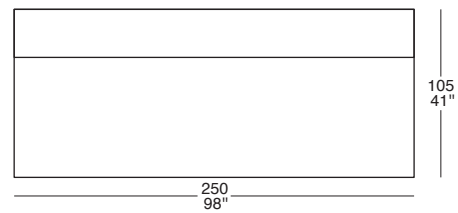

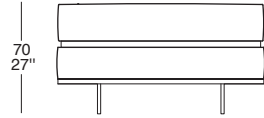
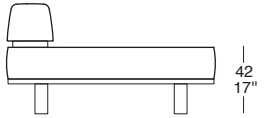

CUB 45

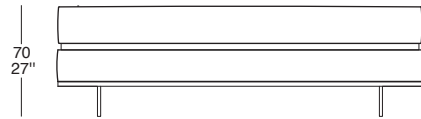
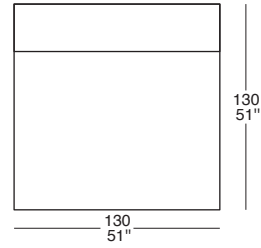

CUB 46

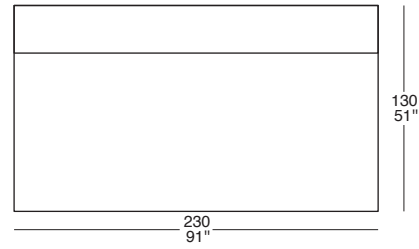

8 ▶

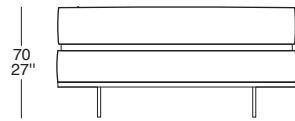
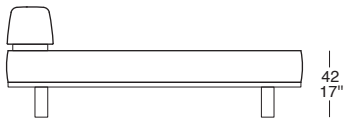

CUB 47

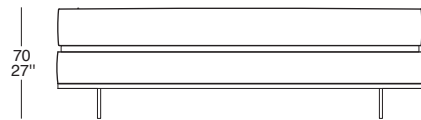
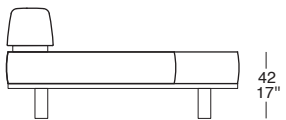
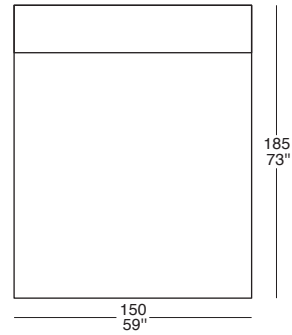

CUB 48

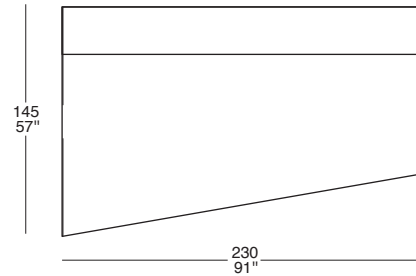

CUB 49

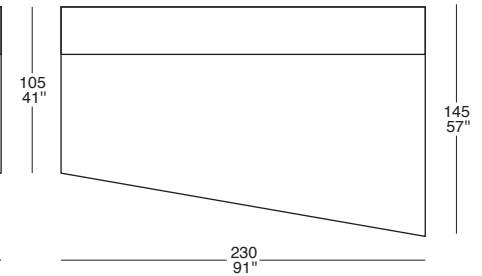

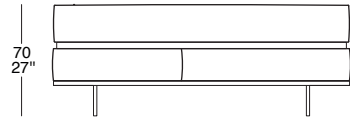
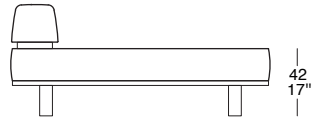

CUB 50

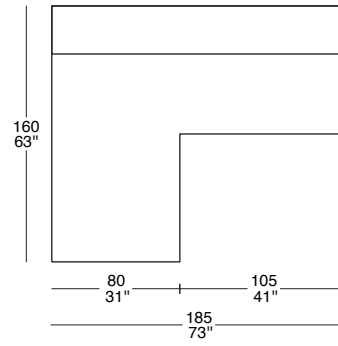

CUB 51

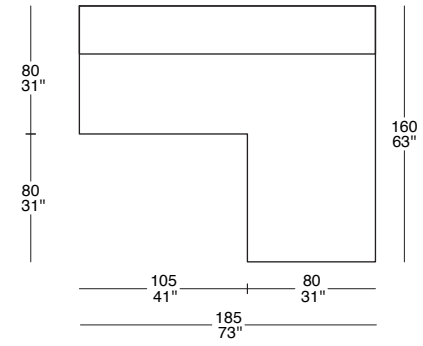

9 ▶

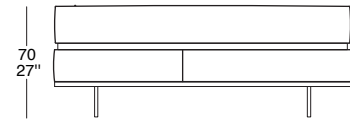
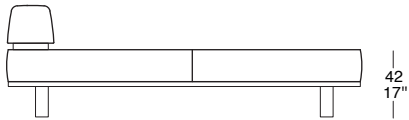

CUB 52

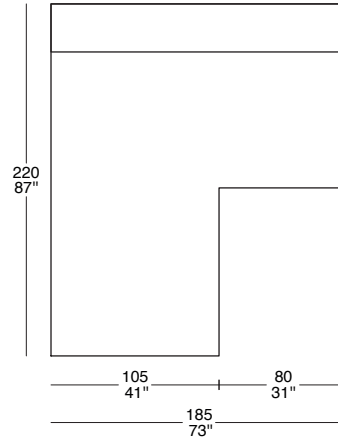

CUB 53

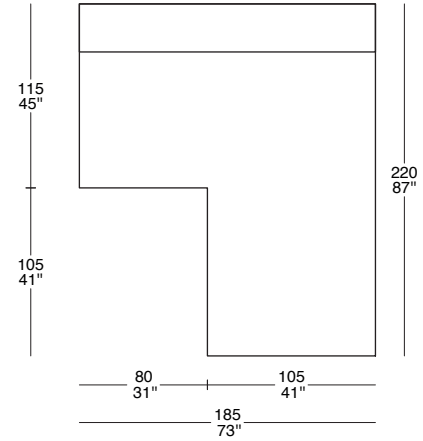

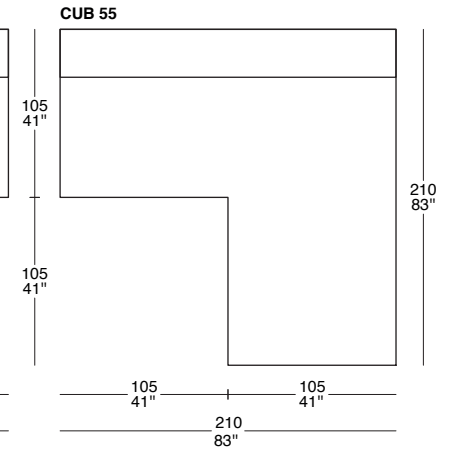
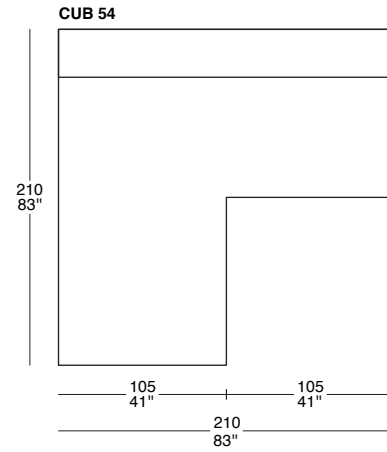
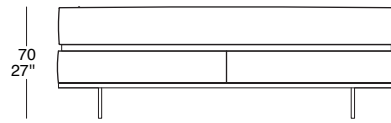

10 ▶

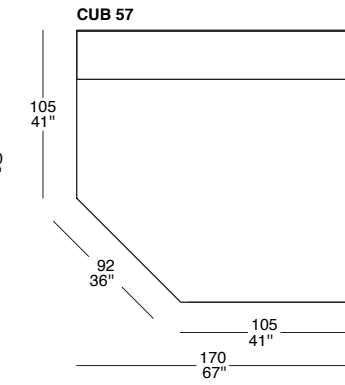
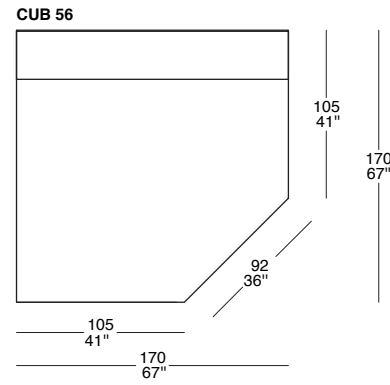
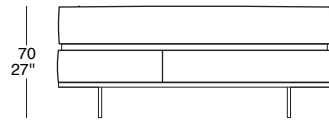
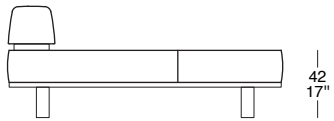

CUB 58

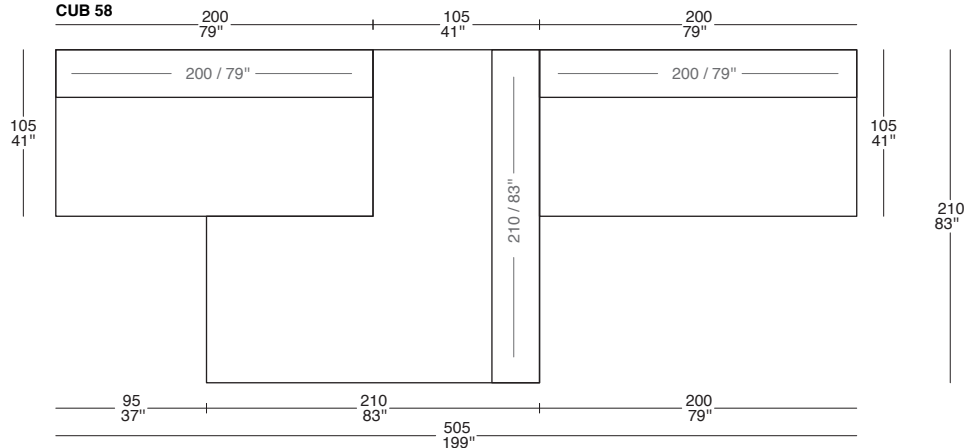

CUB 59

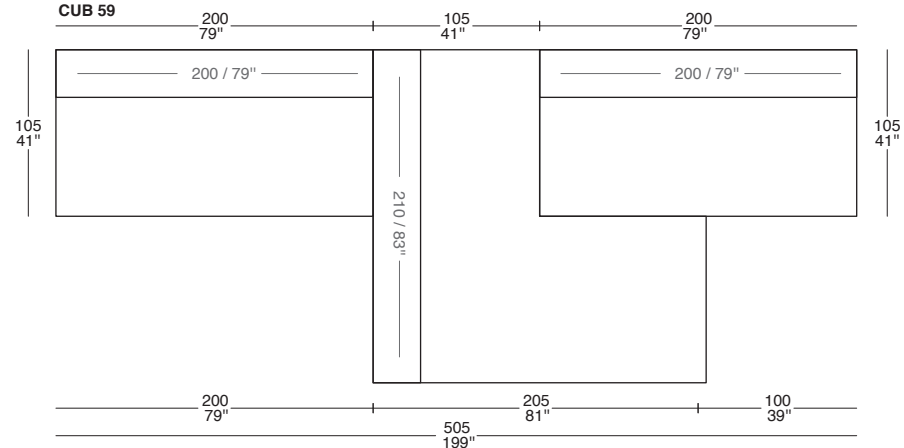

11 ►

CUB 60

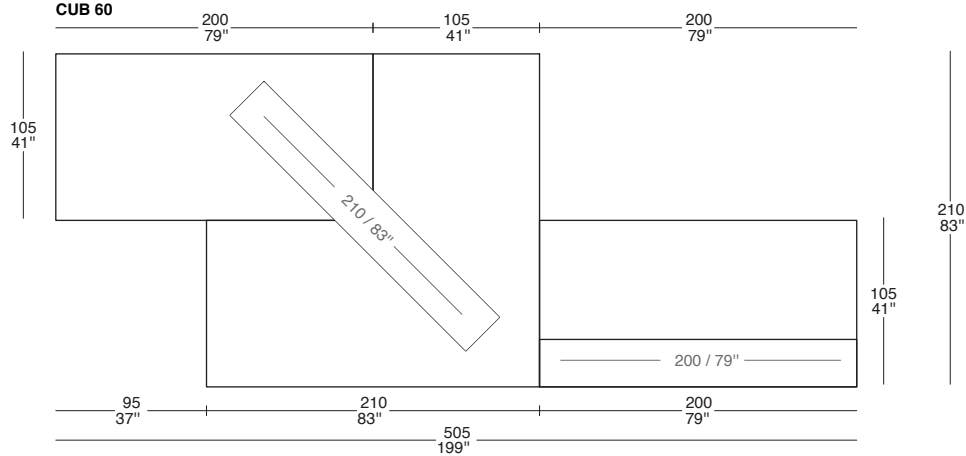

CUB 61

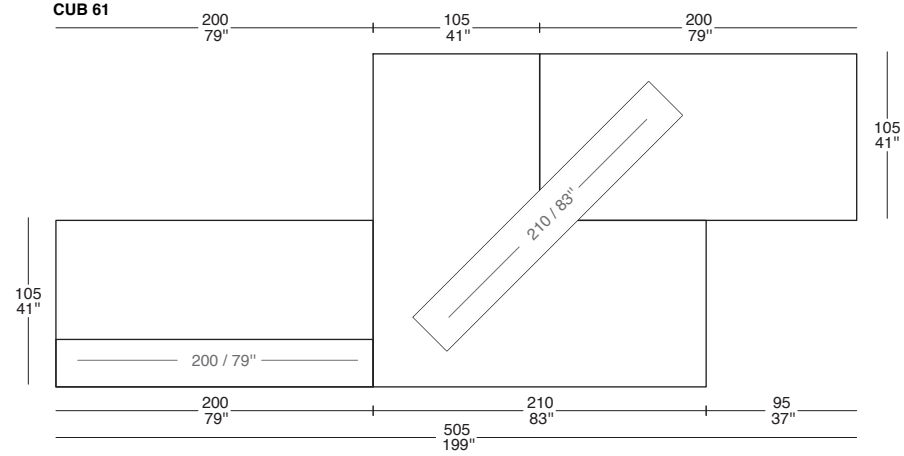

12 ▶

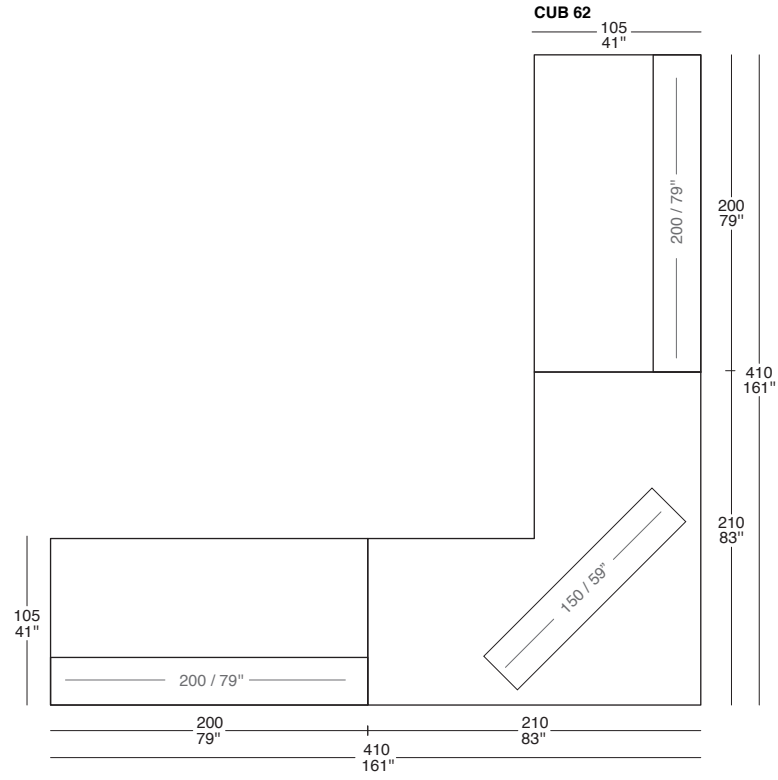

CUB 63

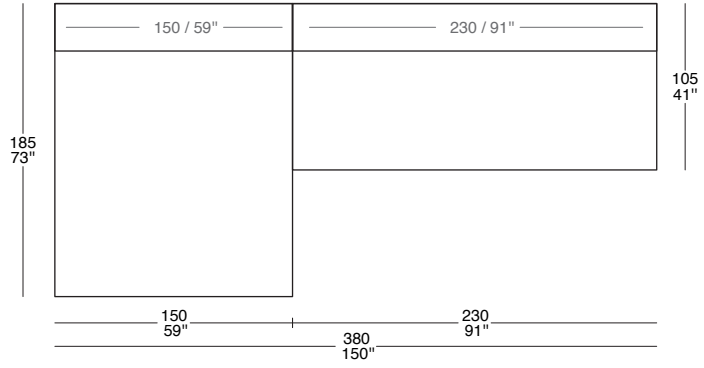

CUB 64

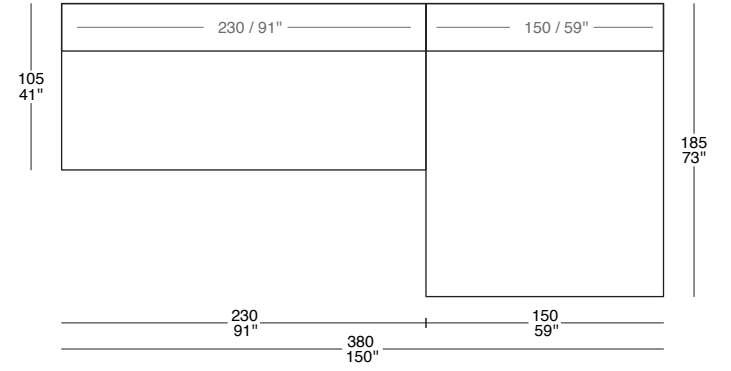

13 ►

CUB 65

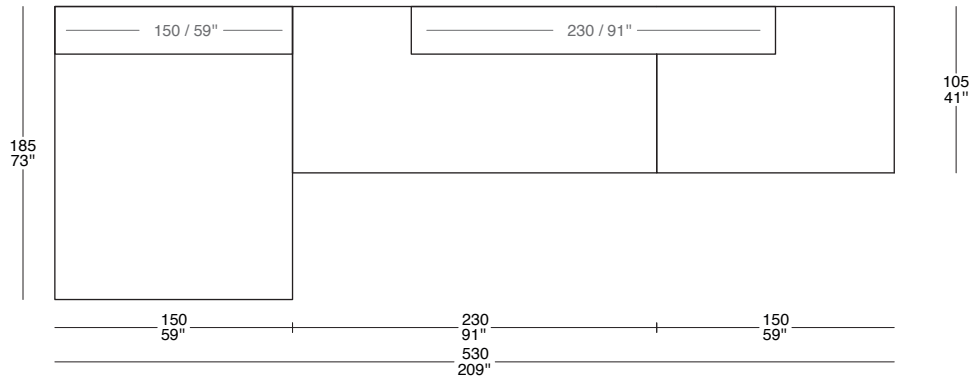

CUB 66

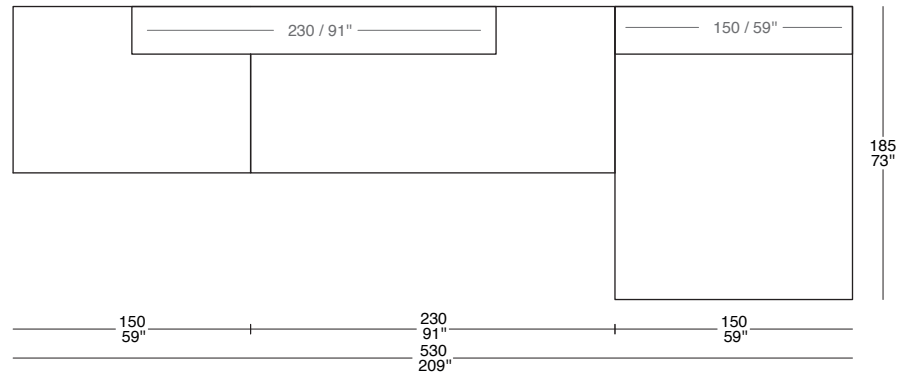

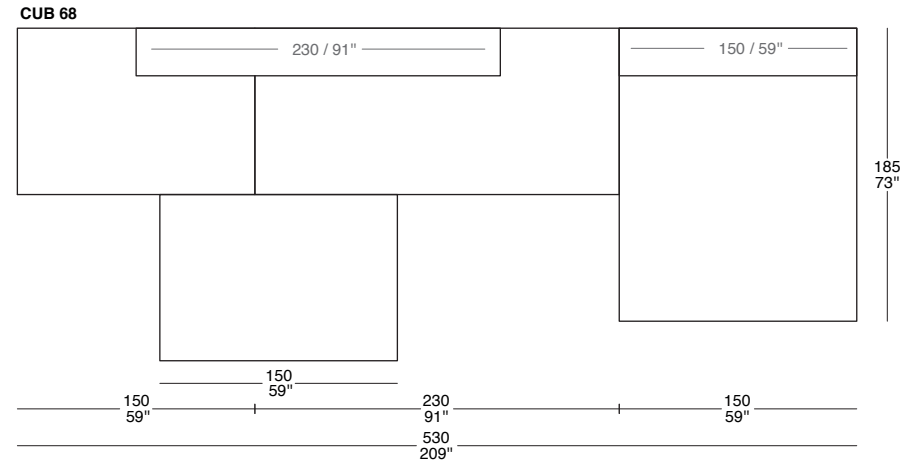
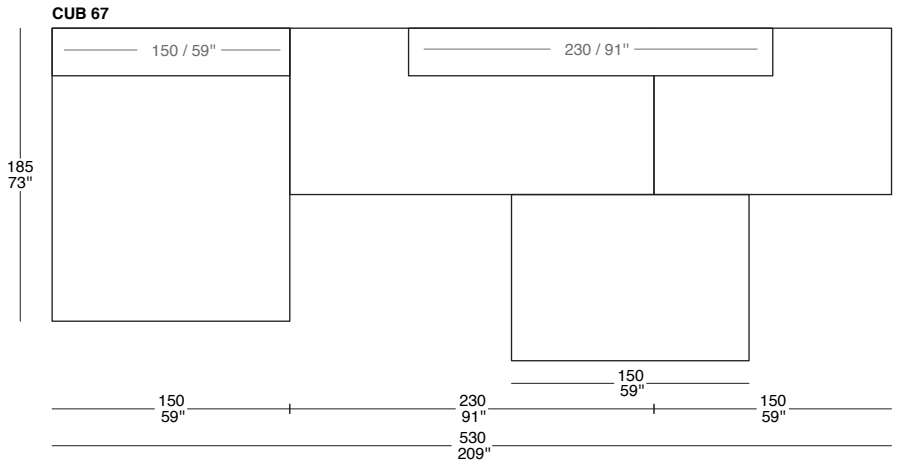

CUB 69

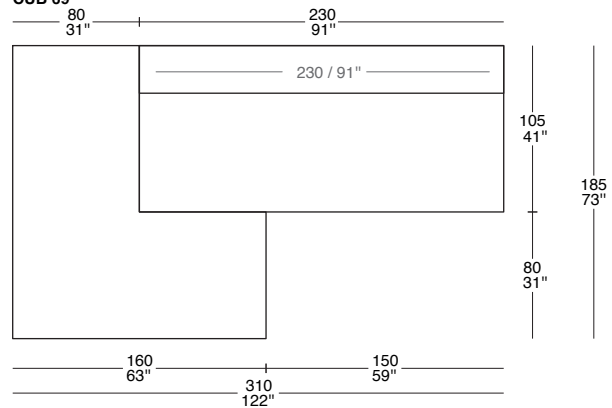

CUB 70

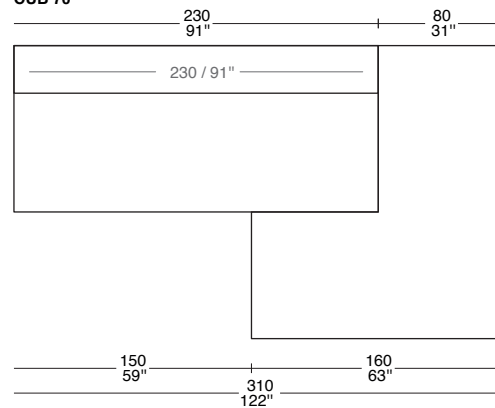

15 ▶

CUB 71

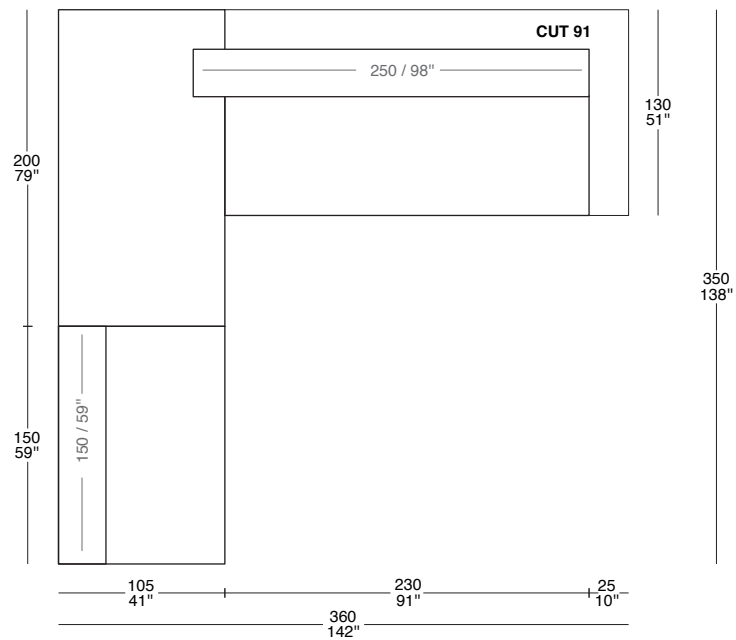

CUB 72

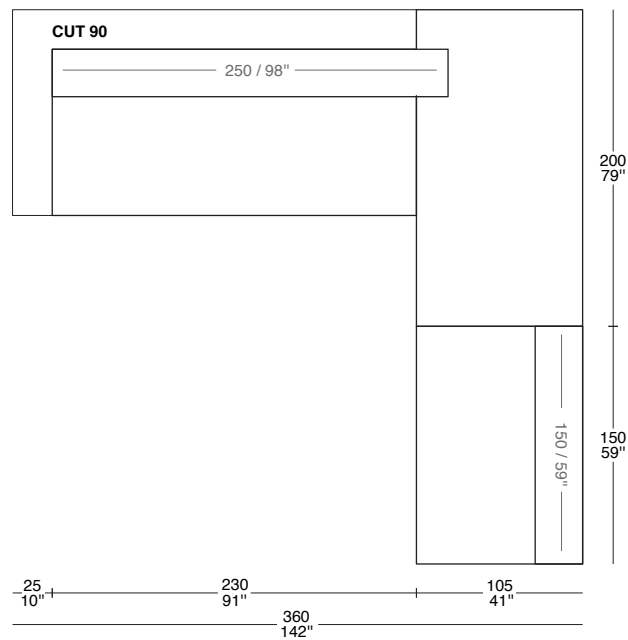

CUB 73

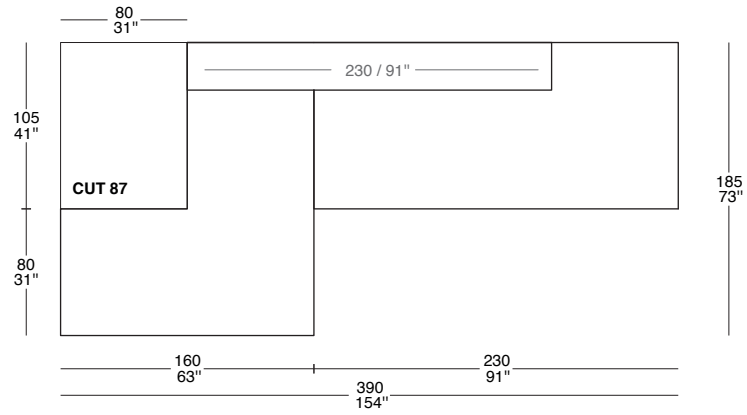

CUB 74

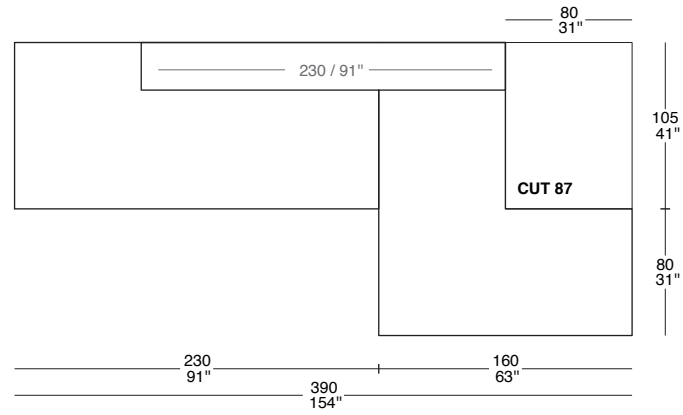

CUB 75

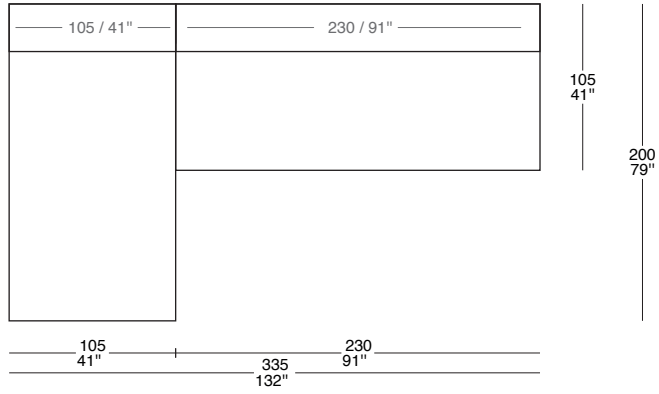

CUB 76

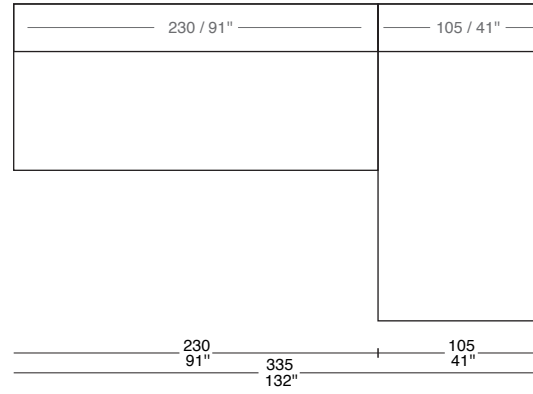

17 ►

CUB 77

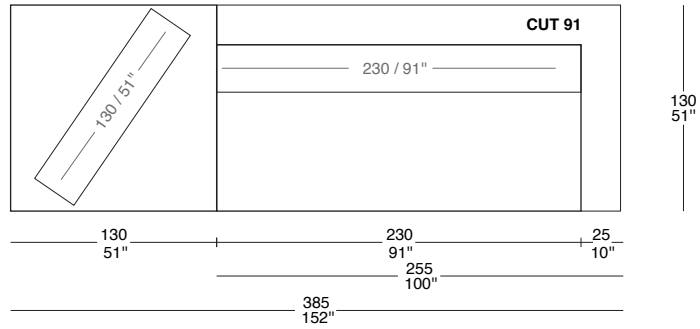

CUB 78

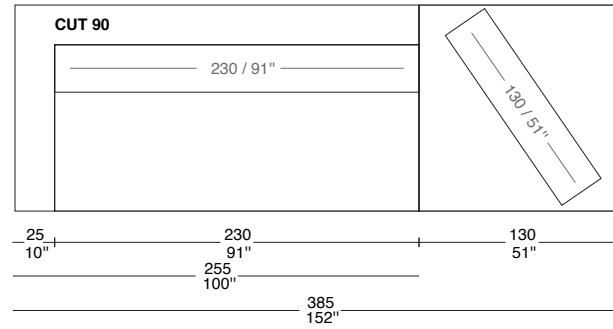

CUB 79

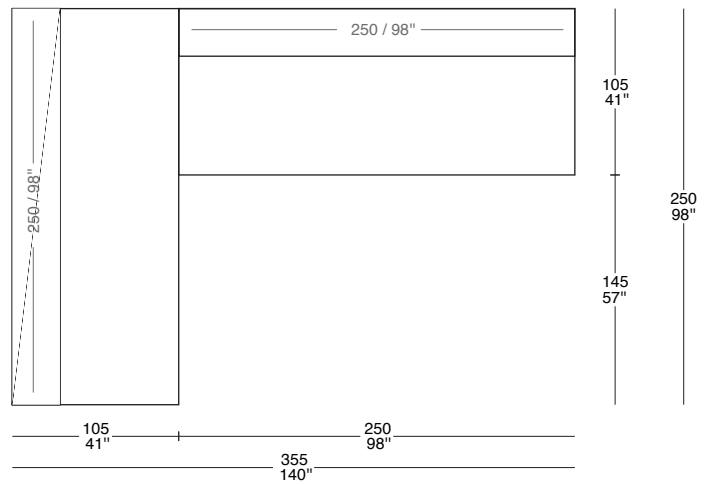

CUB 80

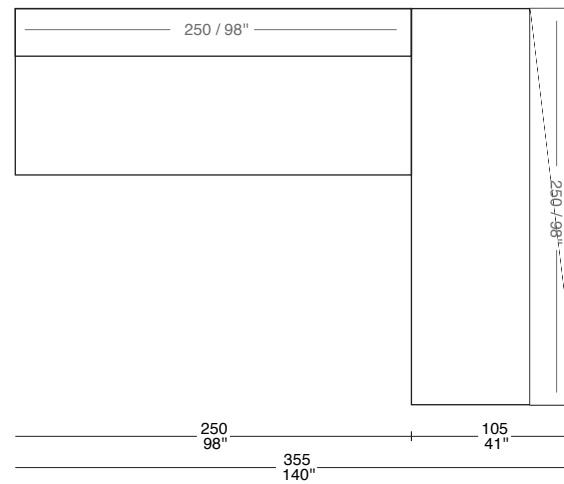

CUB 81

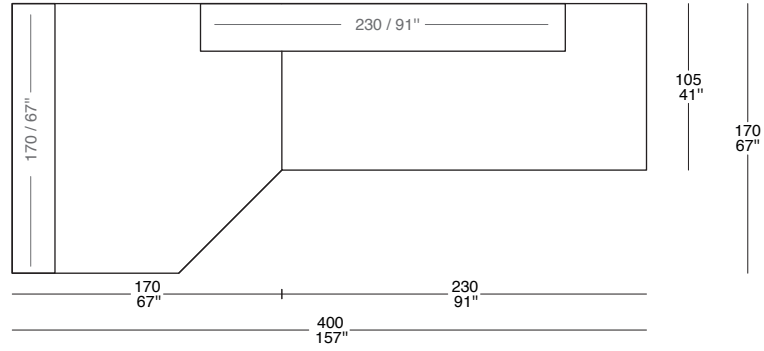

CUB 82

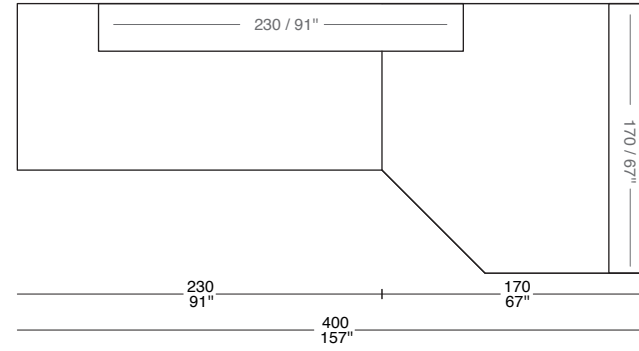

CUB 83

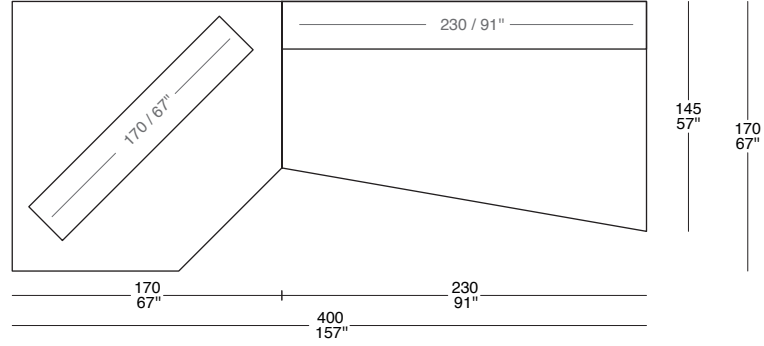

CUB 84

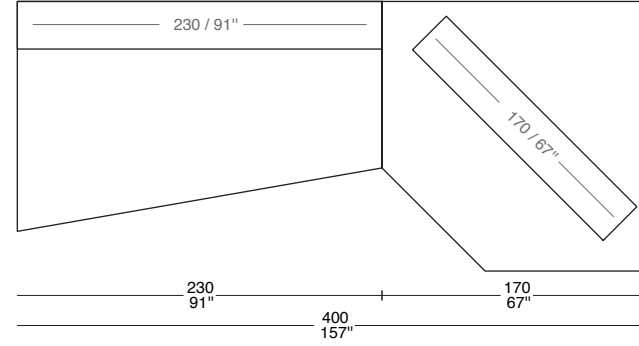

CUB 85

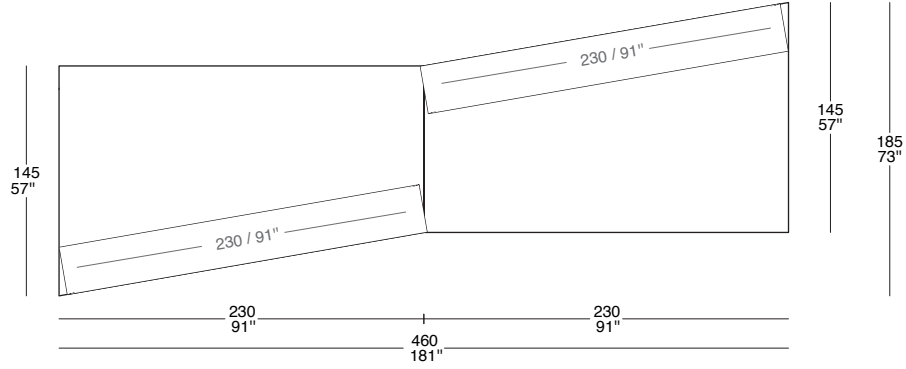

CUB 86

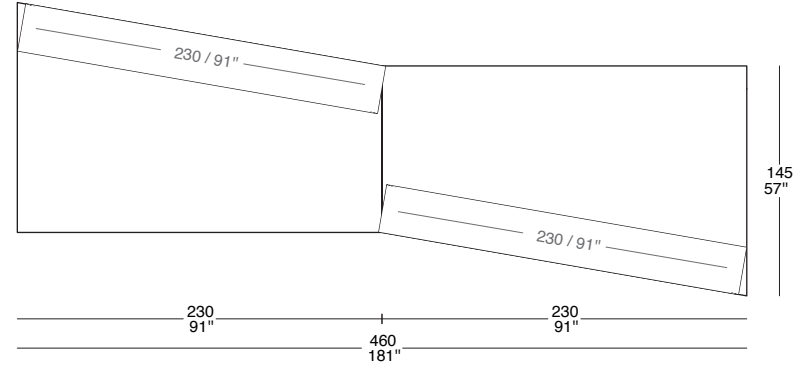

CUB 87

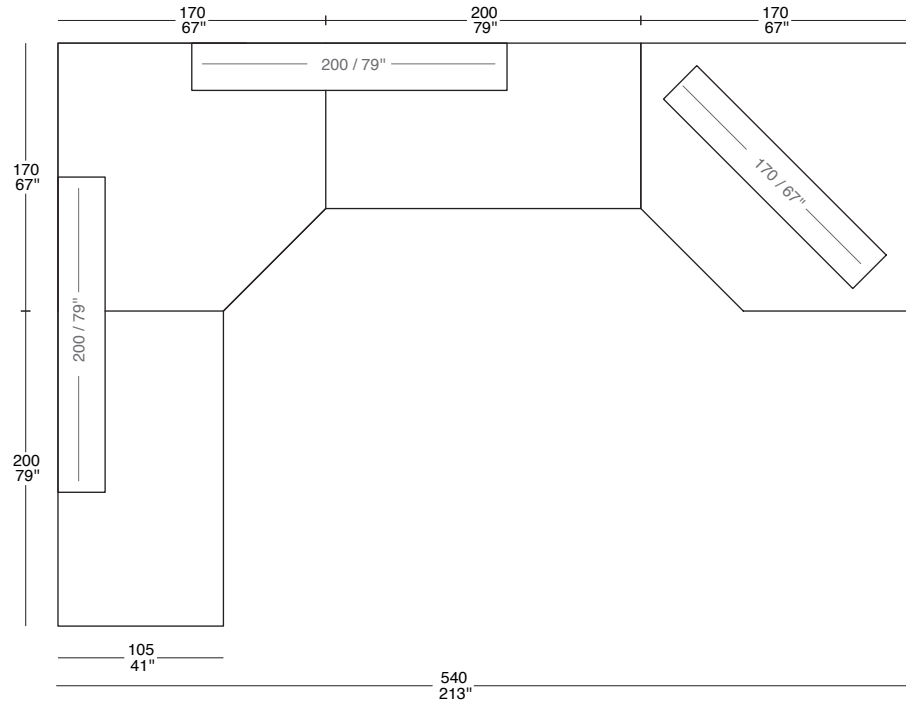

CUB 88

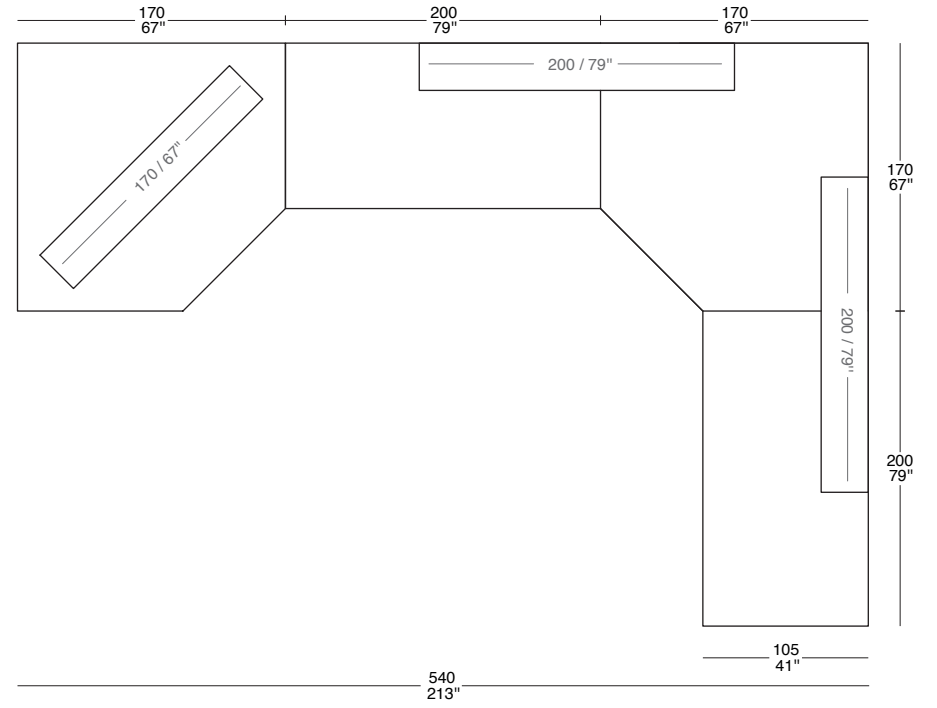

20 ►

CUB 89

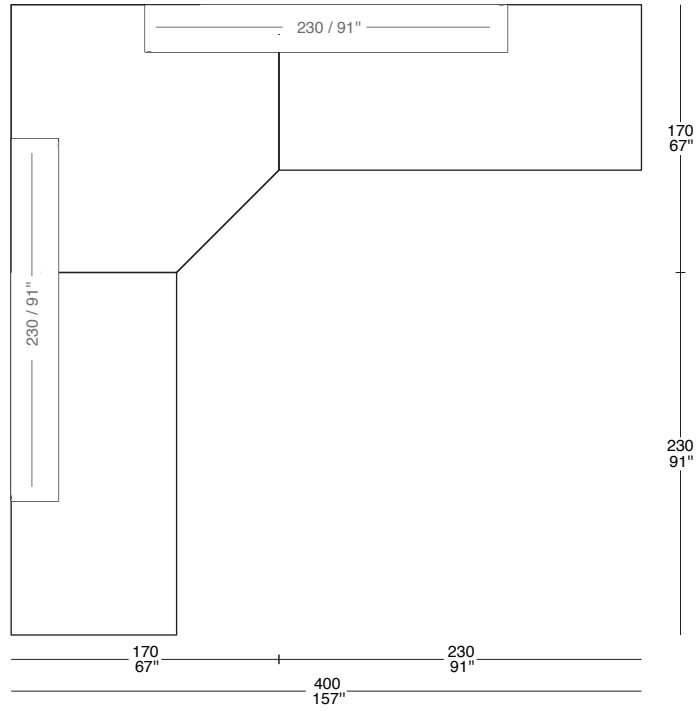

CUB 90

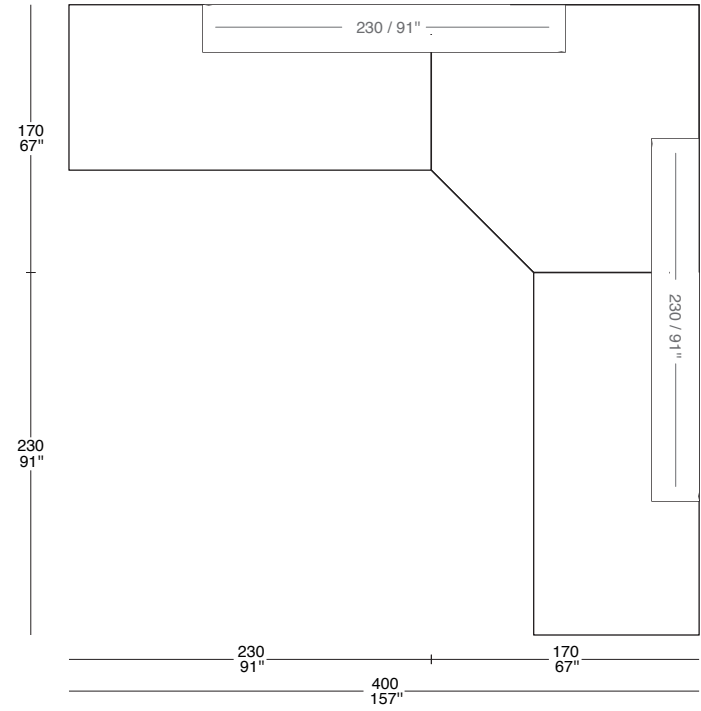

CUB 92

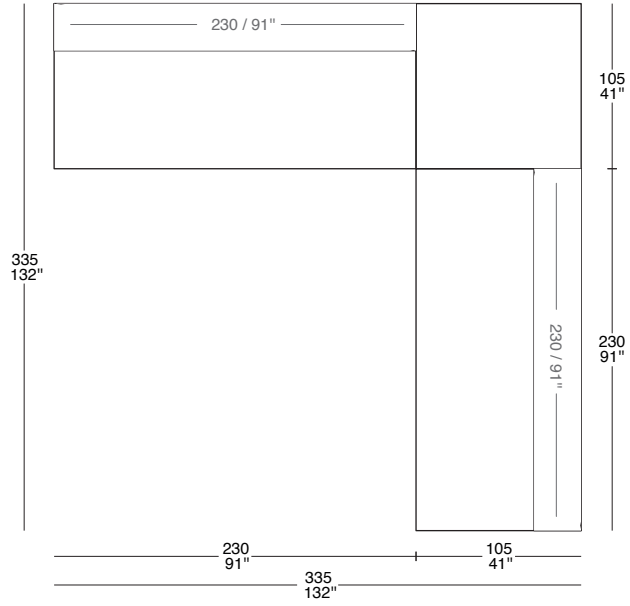

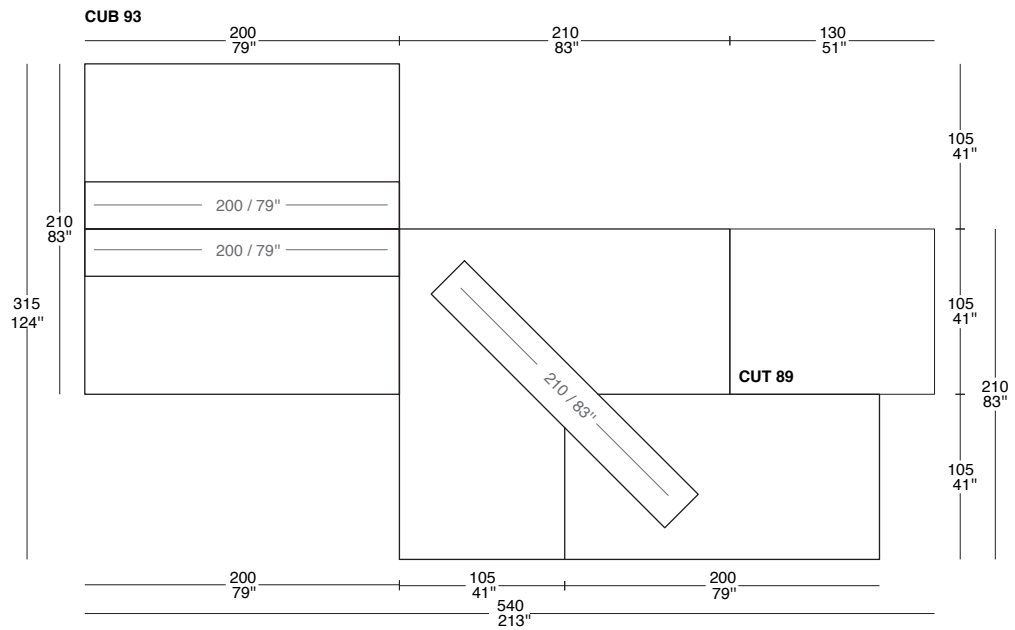

23 ▶

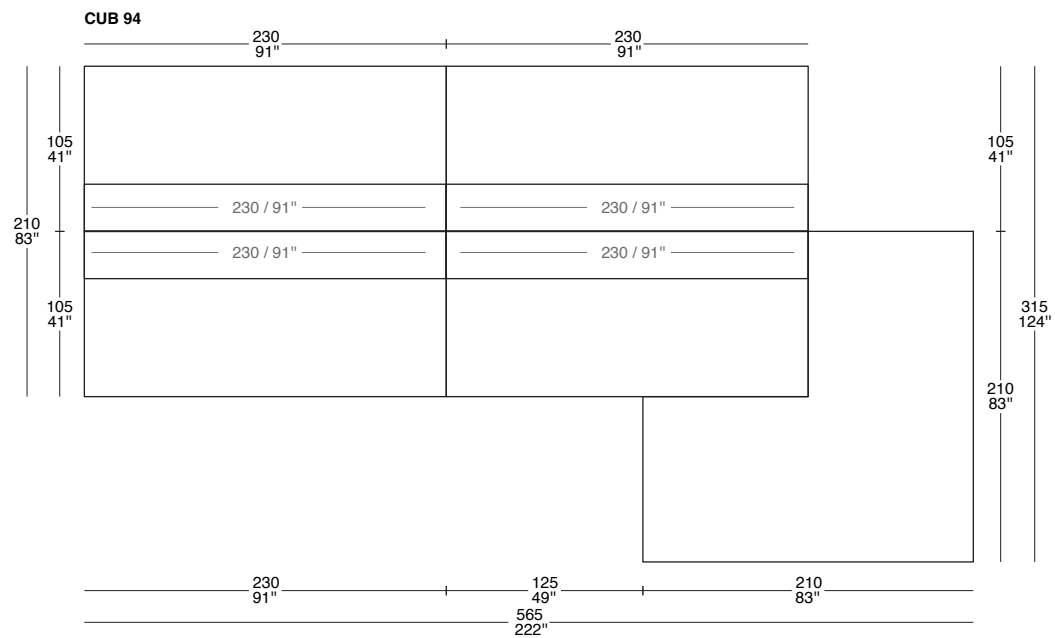

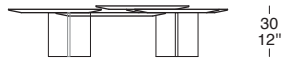

30
12"

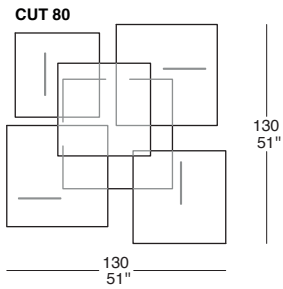

40
16"

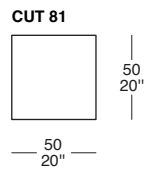

40
16"

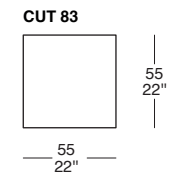

24 ▶



48
19"

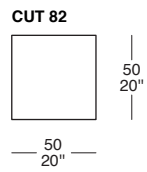

48
19"

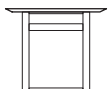
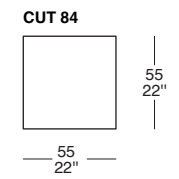

48
19"

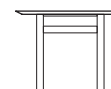
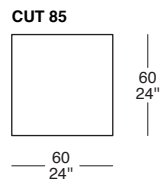
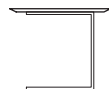

48
19"

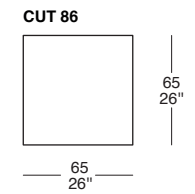

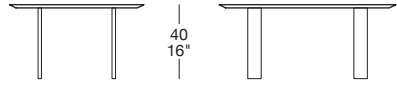

CUT 87

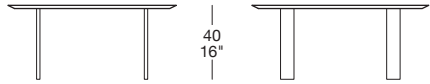
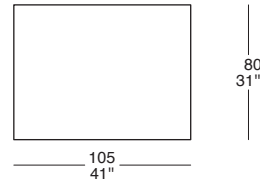

CUT 88

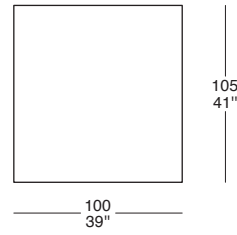

25 ►

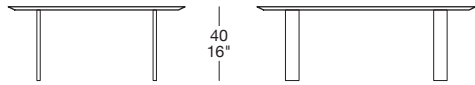

CUT 89

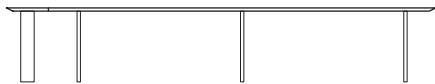
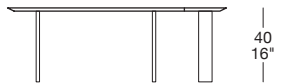
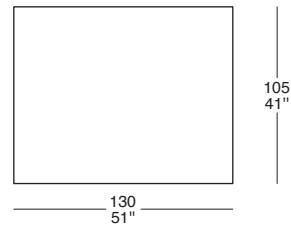

CUT 90

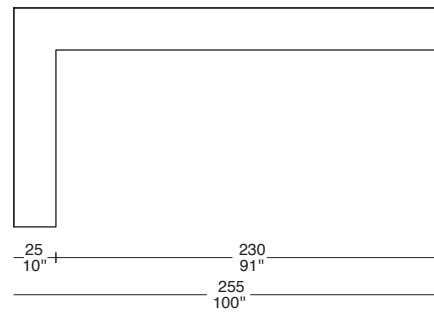

CUT 91

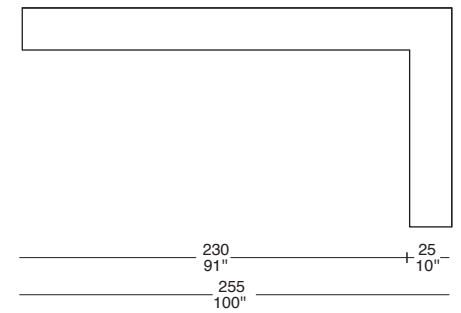

DELTA

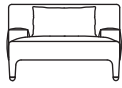
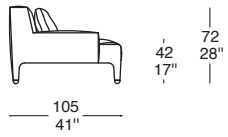

DEL 09

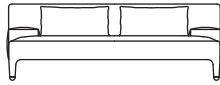
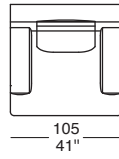

DEL 10

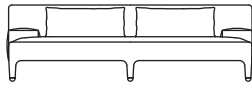
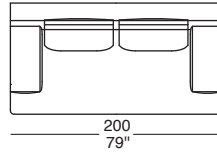

DEL 11

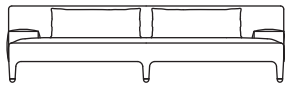
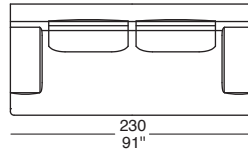

DEL 12

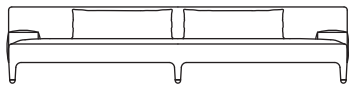
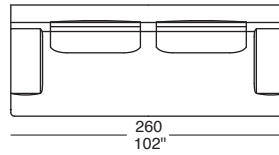

DEL 13

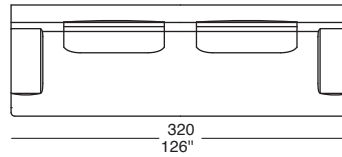

1 ▶

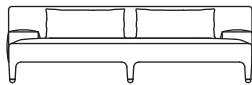
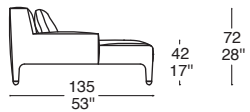

DEL 14

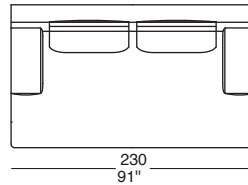

DELTA

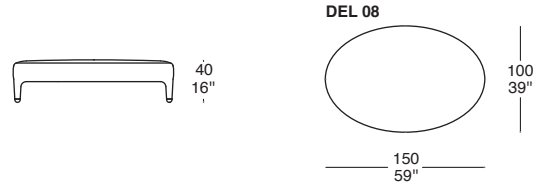
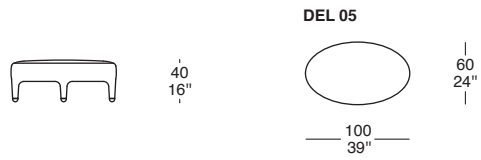

2 ▶

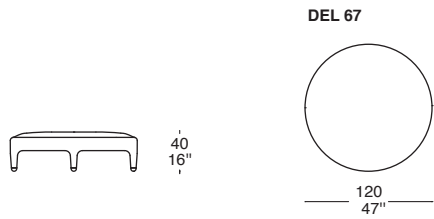
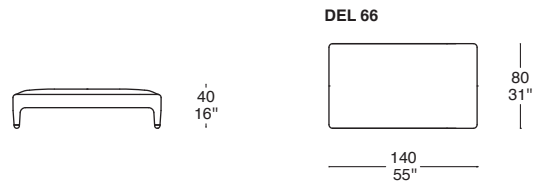
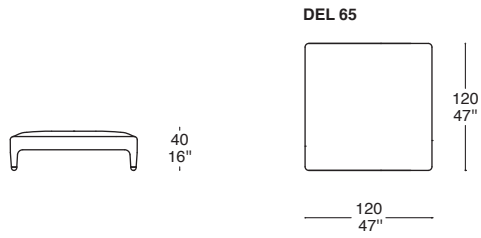

DELTA

DEL 69

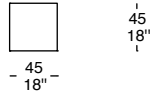

DEL 70

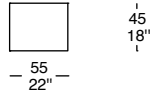

DEL 71

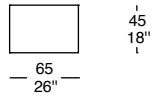

3 ▶

DEL 72

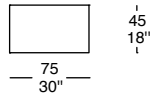

DEL 73

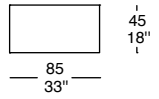

DEL 74

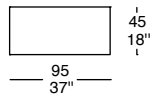

DELTA

DEL 19

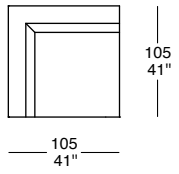

DEL 20

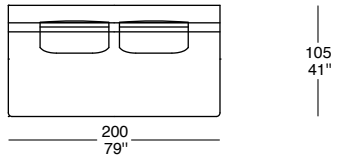

4 ►

DEL 21

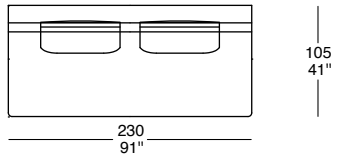

DEL 22

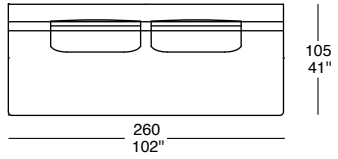

DELTA

DEL 23

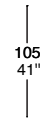
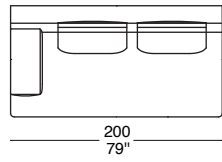

DEL 27

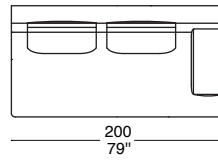

DEL 24

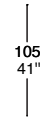
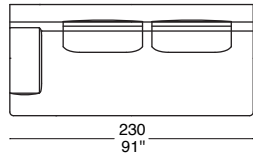

DEL 28

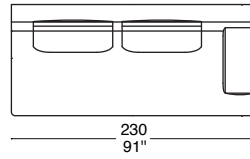

5 ▶

DEL 25

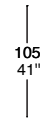
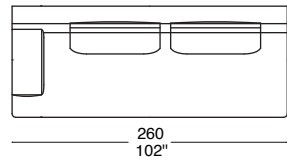

DEL 29

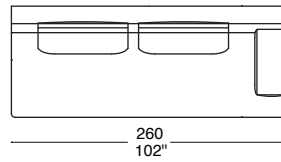

DEL 26

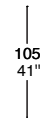
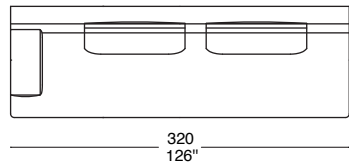

DEL 30

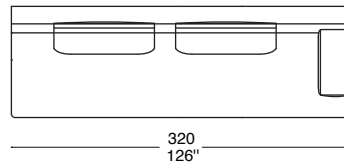

DELTA

DEL 31

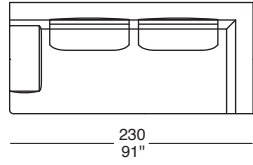

DEL 34

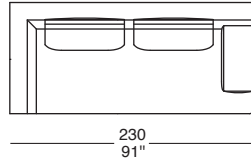

DEL 32

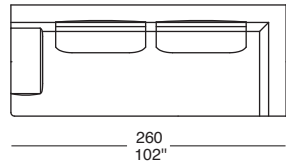

DEL 35

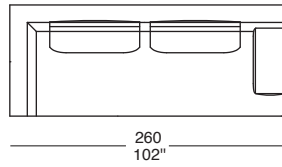

6 ▶

DEL 33

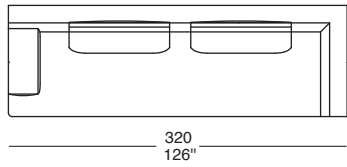

DEL 36

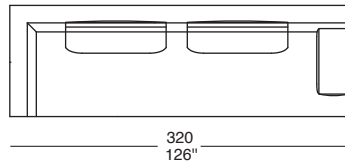

DELTA

DEL 37

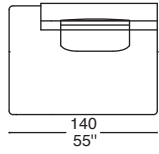

DEL 39

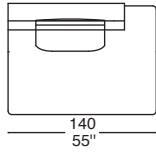

105
41"

DEL 38

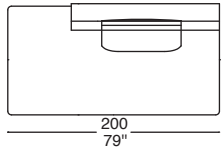

DEL 40

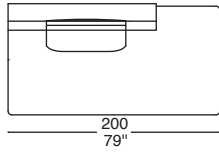

105
41"

DEL 41

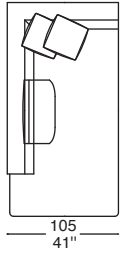

DEL 43

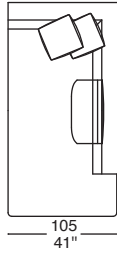

202
80"

DEL 42

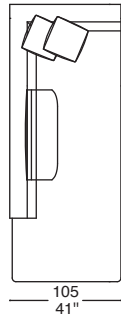

DEL 44

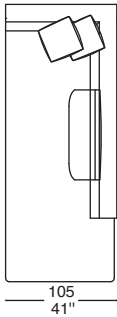

262
103"

DEL 45

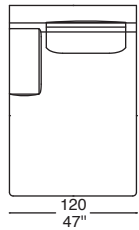

DEL 46

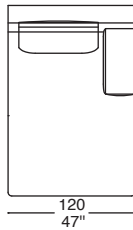

180
71"

DELTA

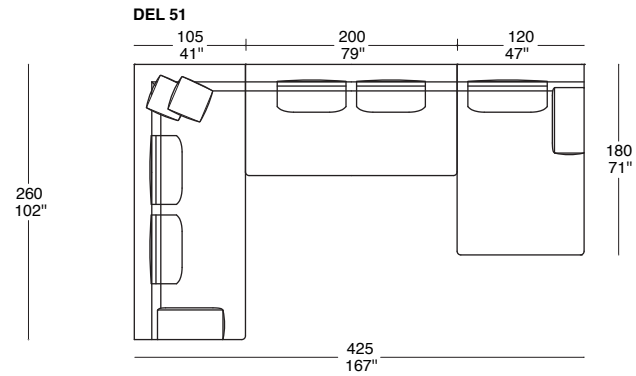
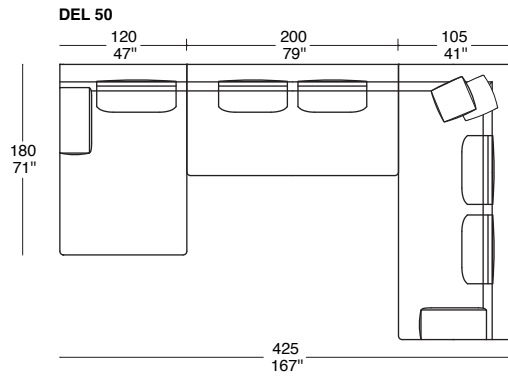
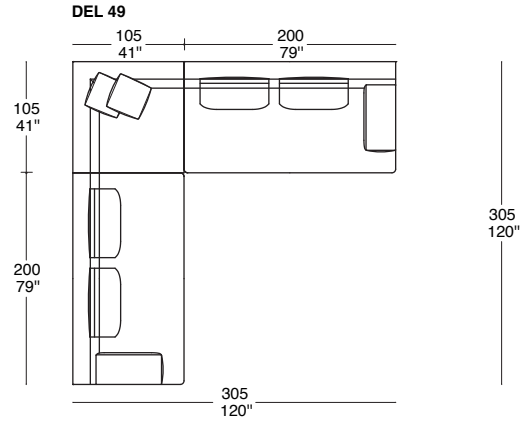
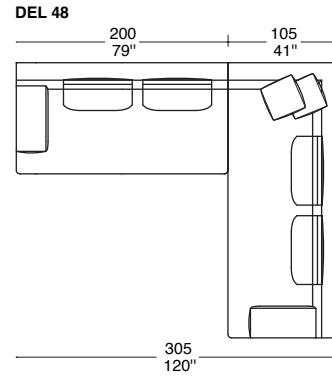
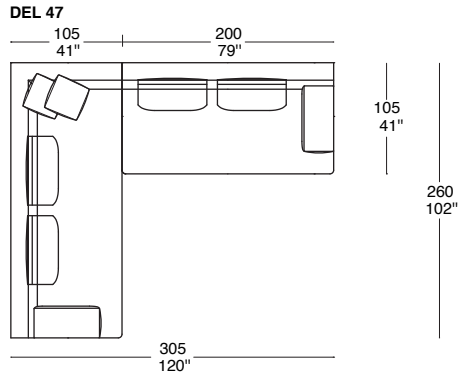

DELTA

DEL 52

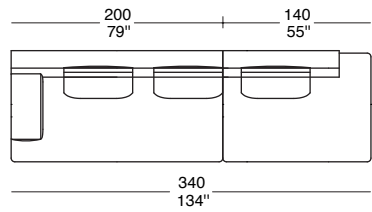

DEL 53

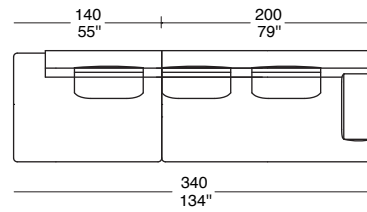

DEL 54

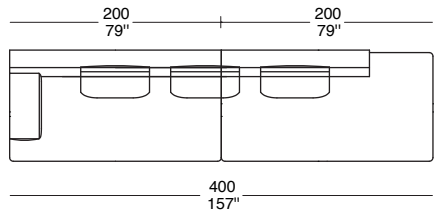

DEL 55

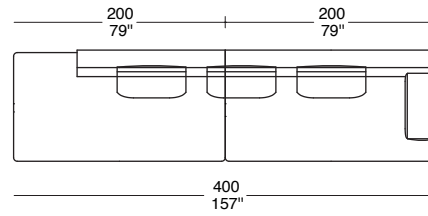

9 ▶

DEL 56

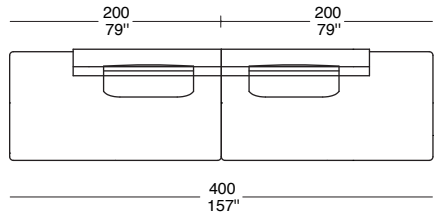

DEL 57

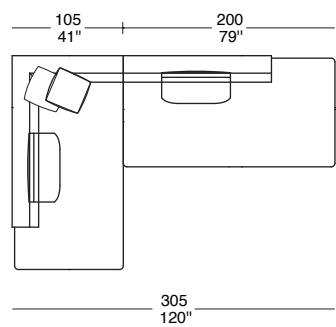

DEL 58

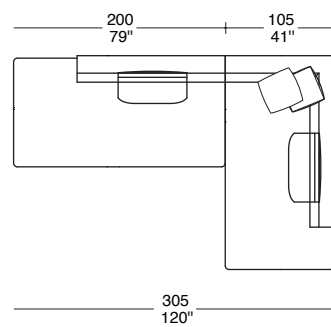

DELTA

DEL 59

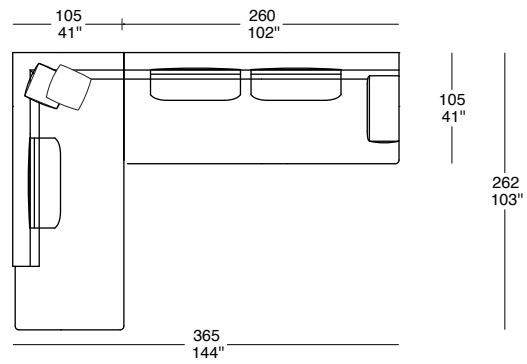

DEL 60

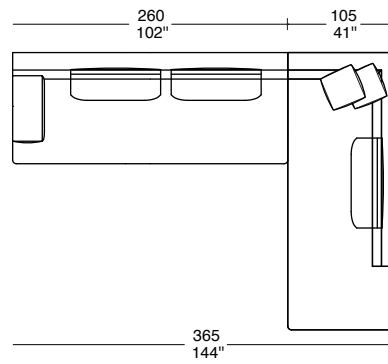

DEL 61

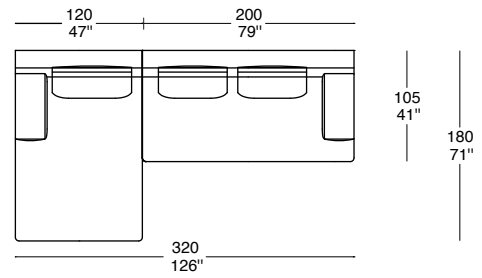

DEL 62

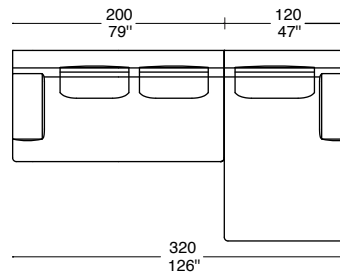

10 ►

DEL 63

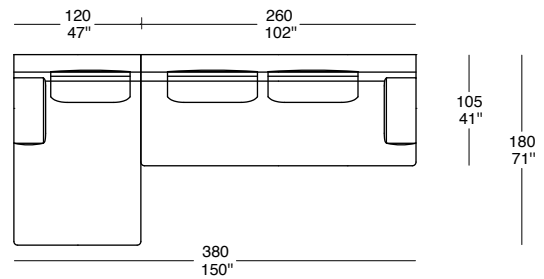

DEL 64

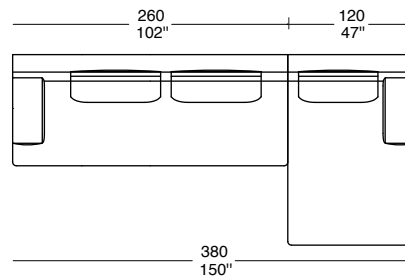

DELTA WOOD

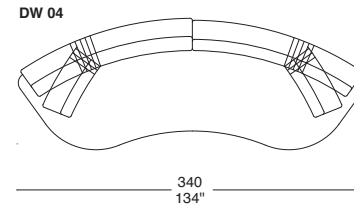
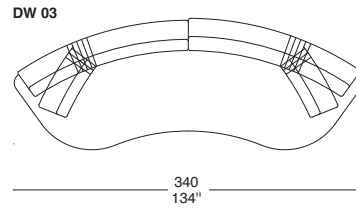
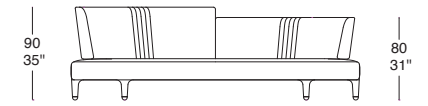
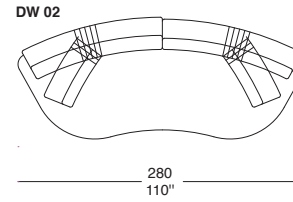
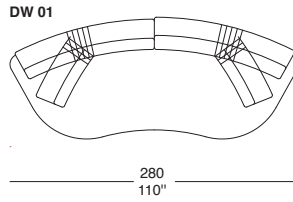
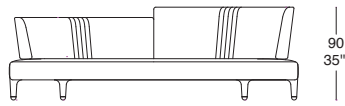
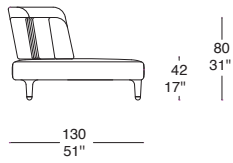

1 ▶

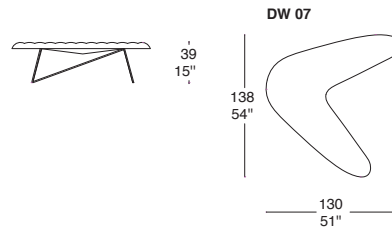
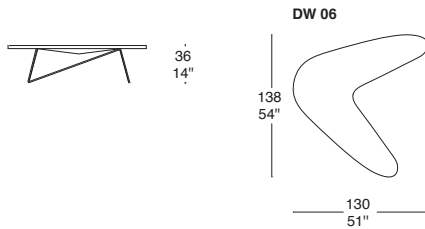
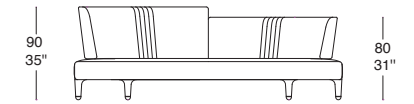
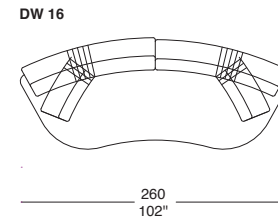
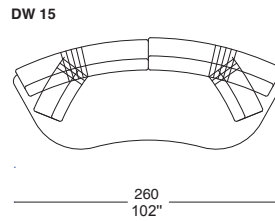
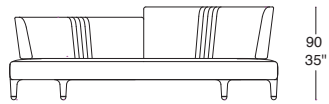
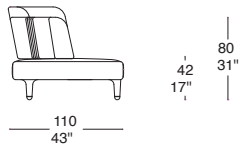

DELTA WOOD

DW 68

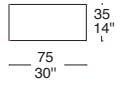

DW 69



DW 70



2 ▶

DW 71

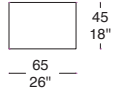

DW 72

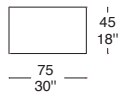

DW 73

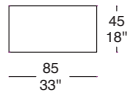

DW 74

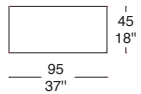

DELTA WOOD

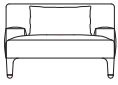
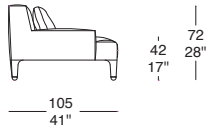

DW 09

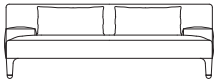
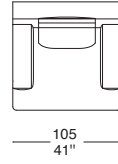

DW 10

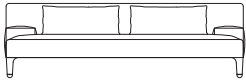
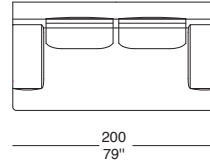

DW 11

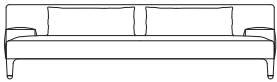
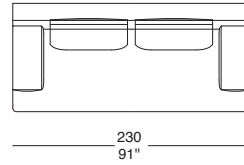

DW 12

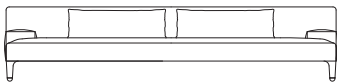
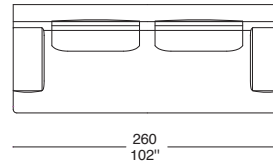

DW 13

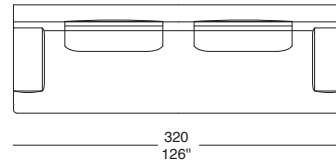

3 ▶

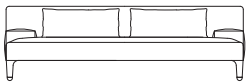
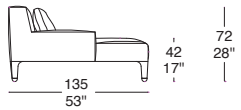

DW 14

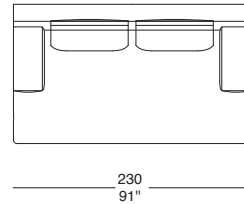

DELTA WOOD

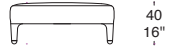

40
16"

DW 05



60
24"

100
39"

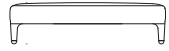

40
16"

DW 08

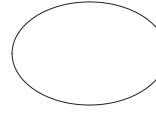

100
39"

150
59"

4 ►



40
16"

DW 65

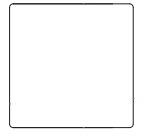

120
47"

120
47"



40
16"

DW 66

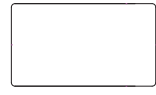

80
31"

140
55"

DW 67



40
16"

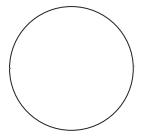

120
47"

DELTA WOOD

DW 69



DW 70



DW 71



5 ▶

DW 72



DW 73



DW 74



DELTA WOOD

DW 19

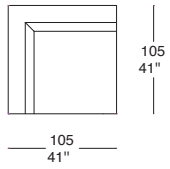

DW 20

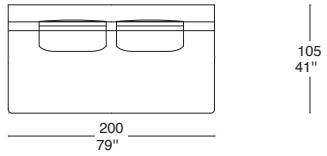

6 ▶

DW 21

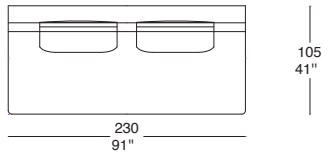

DW 22

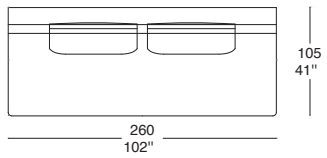

DELTA WOOD

DW 23

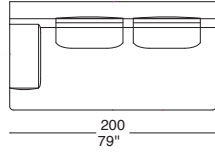

105
41"

DW 27

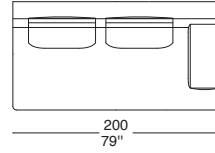

DW 24

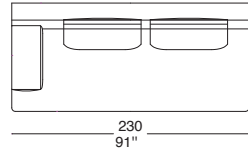

105
41"

DW 28

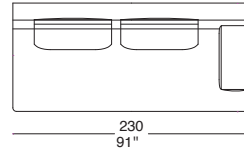

7 ▶

DW 25

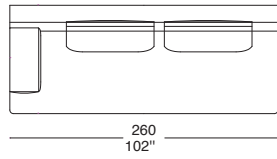

105
41"

DW 29

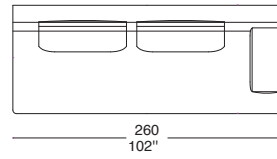

DW 26

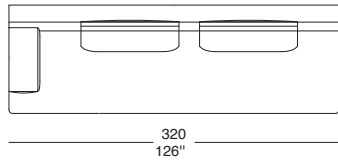

105
41"

DW 30

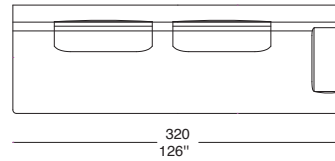

DELTA WOOD

DW 31

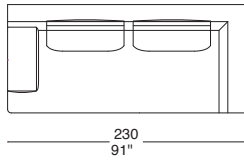

DW 34

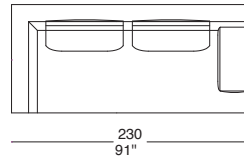

105
41"

DW 32

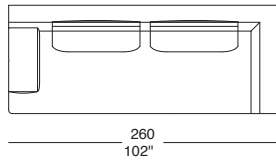

DW 35

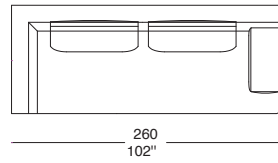

105
41"

8 ▶

DW 33

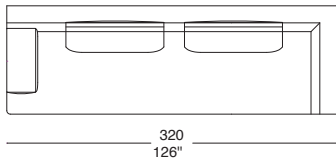

DW 36

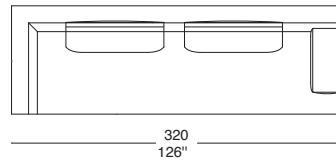

105
41"

DELTA WOOD

DW 37

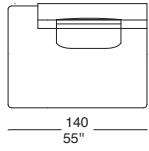

105
41"

DW 39

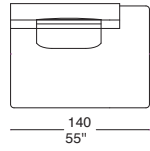

DW 38

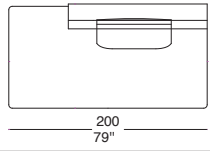

105
41"

DW 40

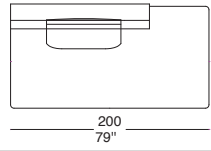

DW 41

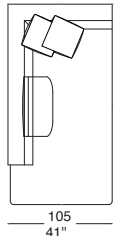

202
80"

DW 43

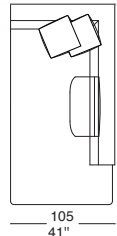

DW 42

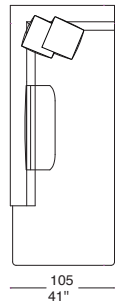

262
103"

DW 44

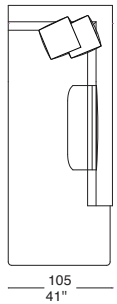

DW 45

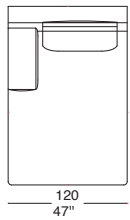

180
71"

DW 46

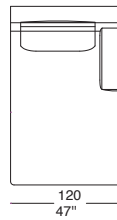

DELTA WOOD

DW 47

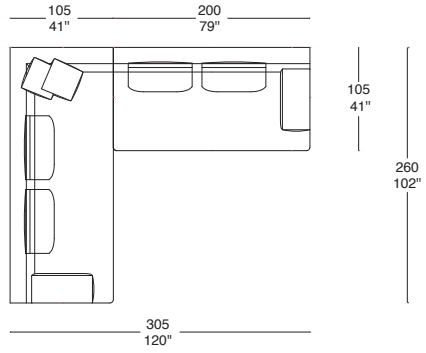

DW 48

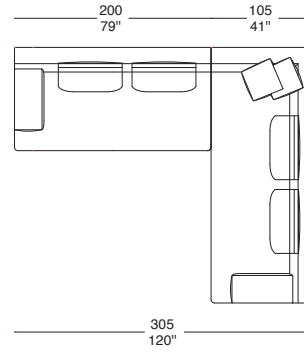

DW 49

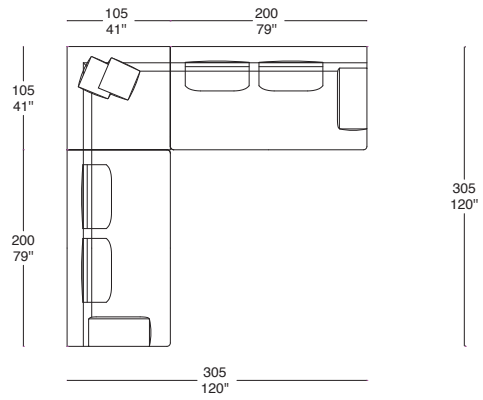

DW 50

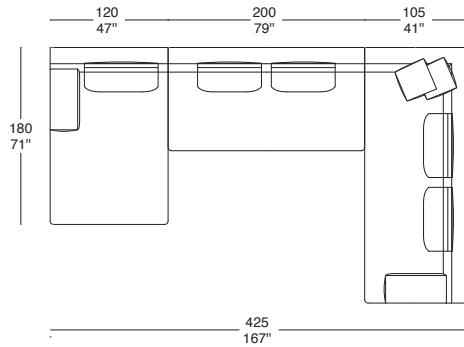

DW 51

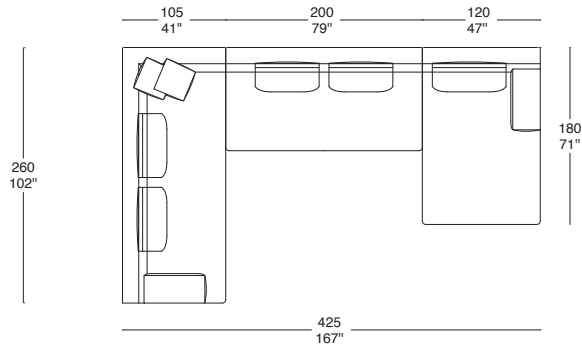

DELTA WOOD

DW 52

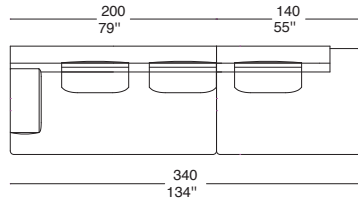

105
41"

DW 53

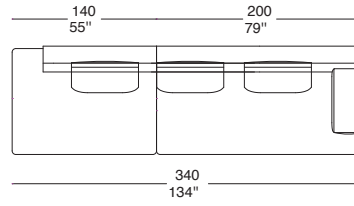

DW 54

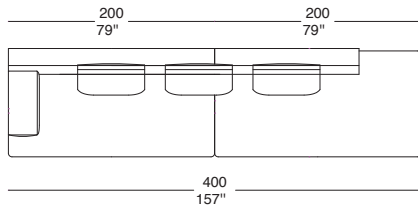

105
41"

DW 55

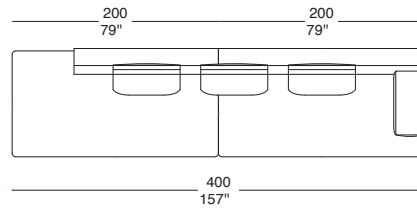

11 ▶

DW 56

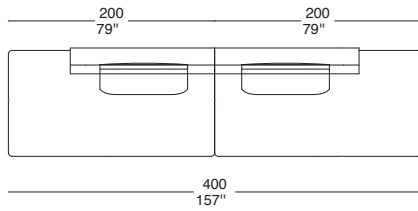

105
41"

DW 57

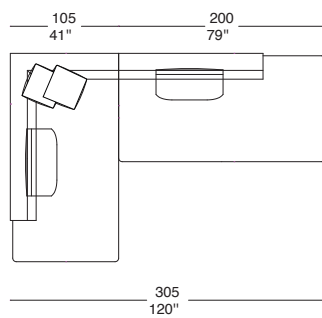

105
41"

202
80"

DW 58

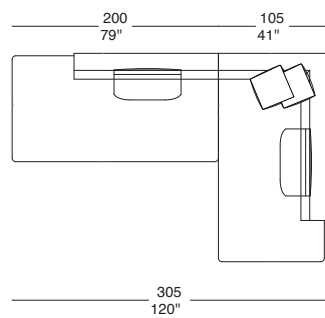

105
41"

202
80"

DELTA WOOD

DW 59

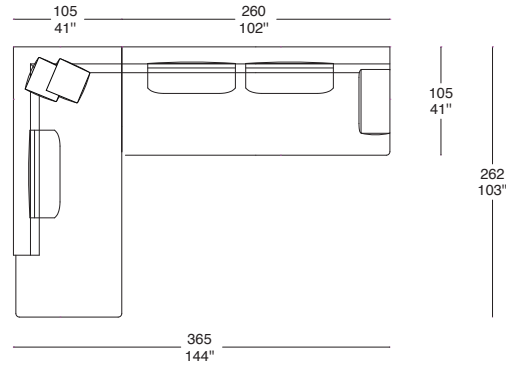

DW 60

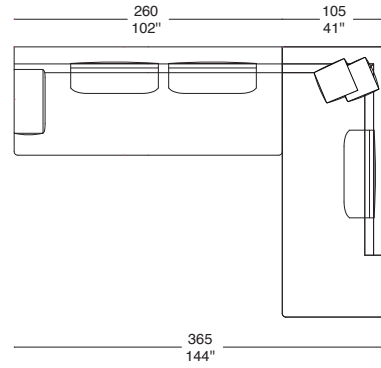

DW 61

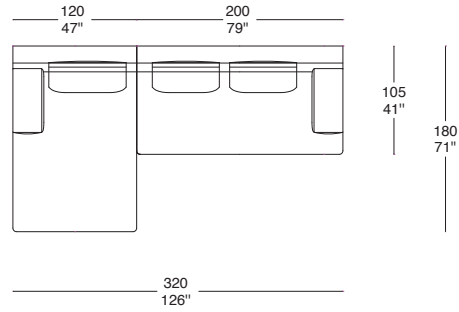

DW 62

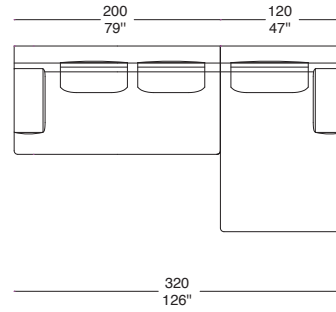

12 ▶

DW 63

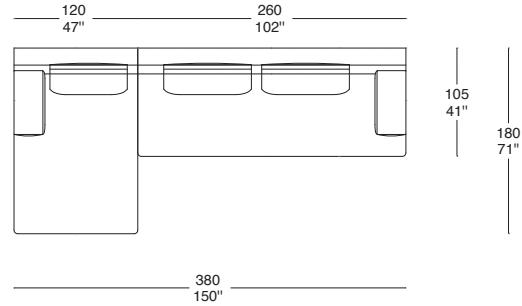

DW 64

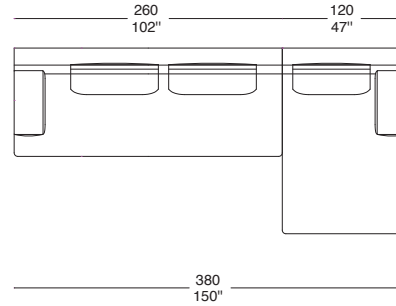

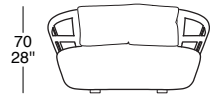
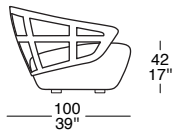

FLA 01

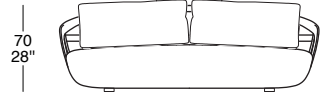
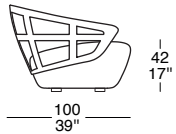
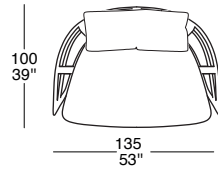

FLA 02

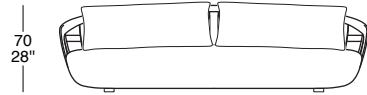
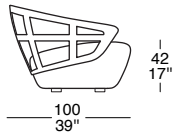
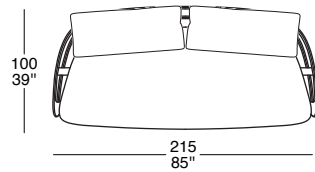

FLA 03

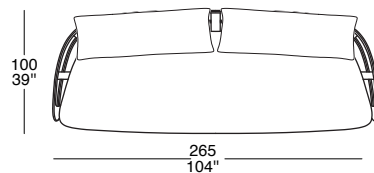

1 ▶

CUSCINI / CUSHIONS

FLA 04

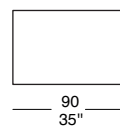

FLA 05

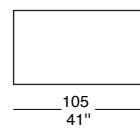

FLA 06

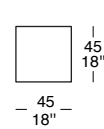

FLA 07

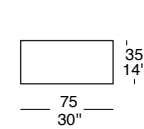

POUFF

FLA 10

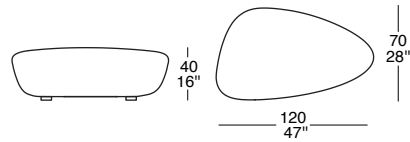

TAVOLINO / LOW TABLE

FLA 11

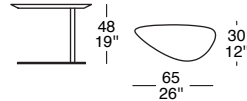

FLA 12

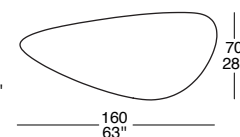

FLA 13

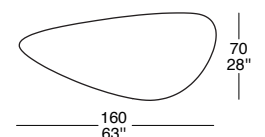

FLOWER

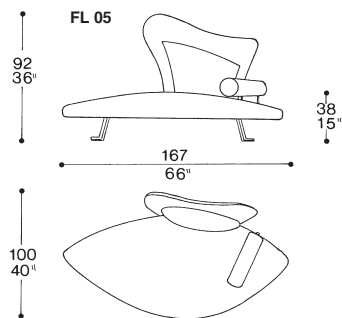
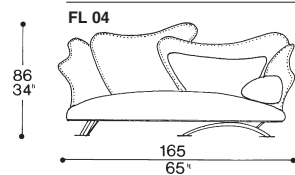
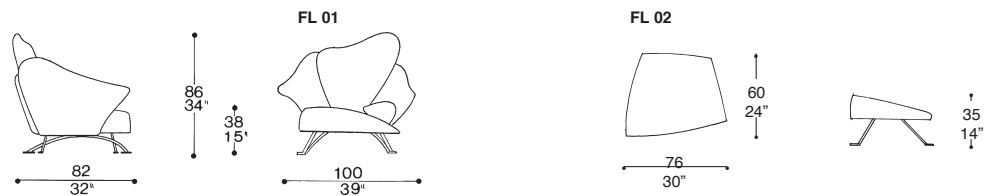

1 ►

FLOWER IMBOTTITA

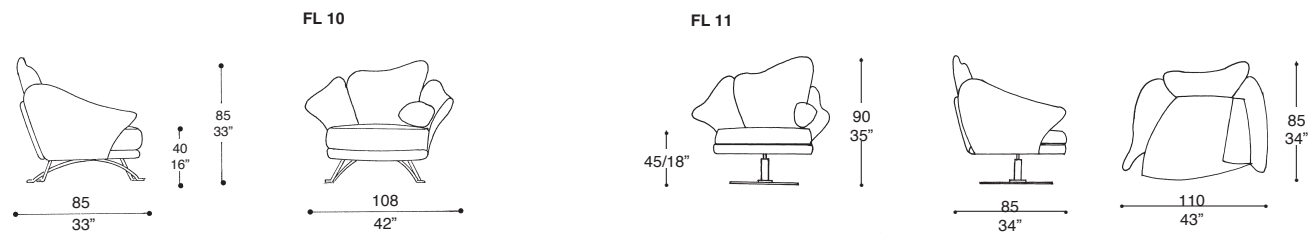

FLY

FLY 12

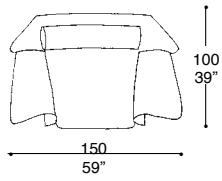

FLY 10

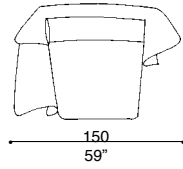

FLY 11

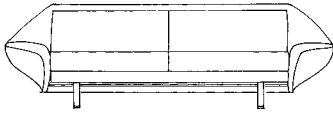
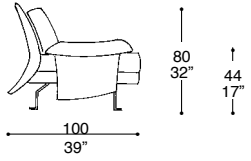
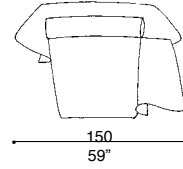

FLY 01

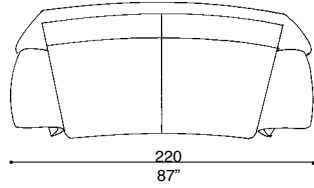

FLY 02

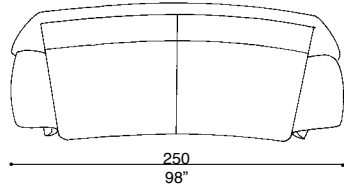

FLY 03

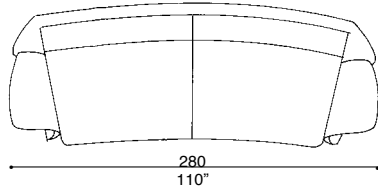

FLY 40

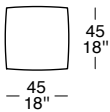

FLY

FLY 36

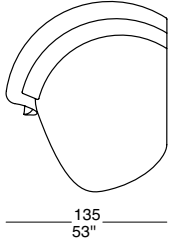

FLY 37

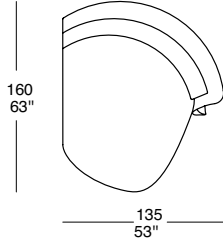

160
63"

FLY 38

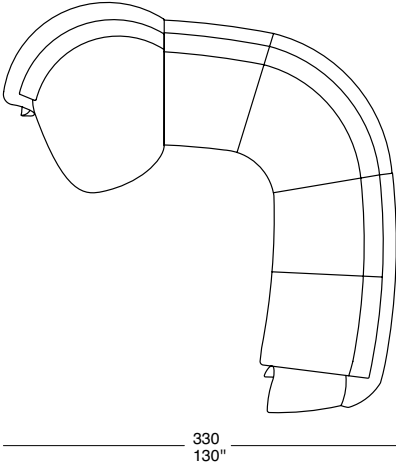

FLY 39

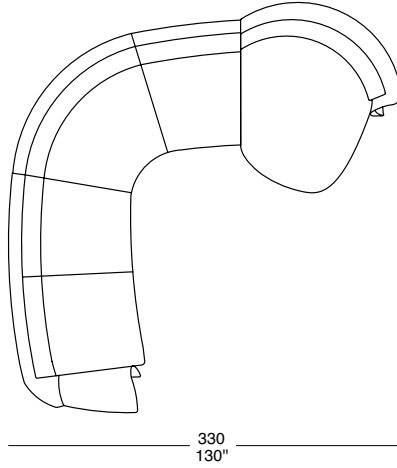

345
136"

2 ▶

FLY

FLY 04

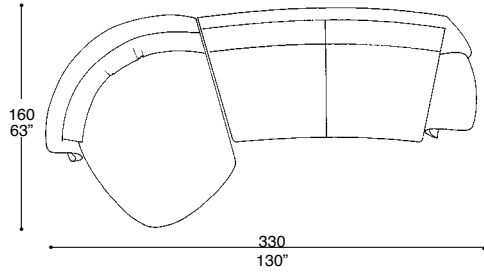

FLY 05

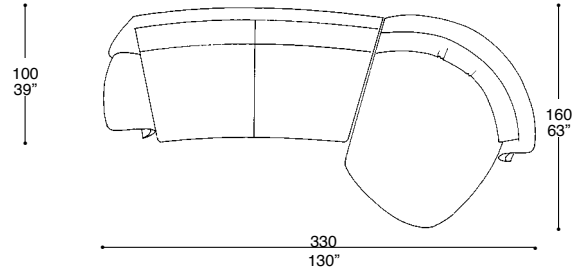

FLY 06

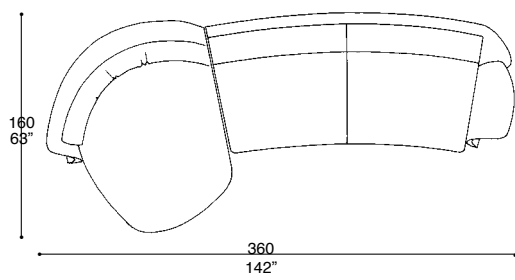

FLY 07

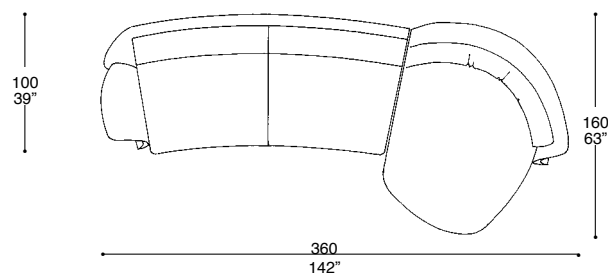

FLY 08

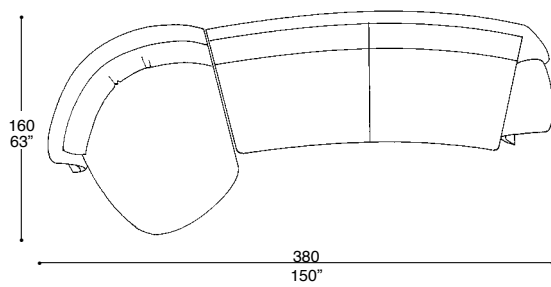

FLY 09

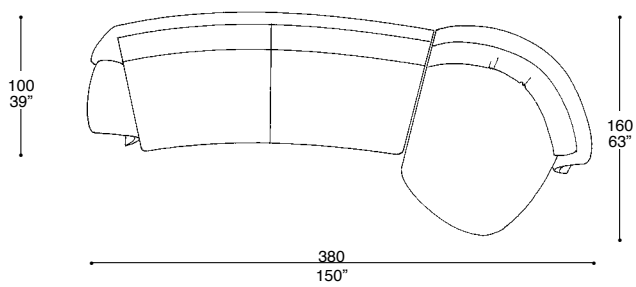

FLY

FLY 13

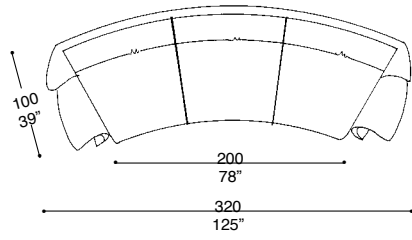

FLY 14

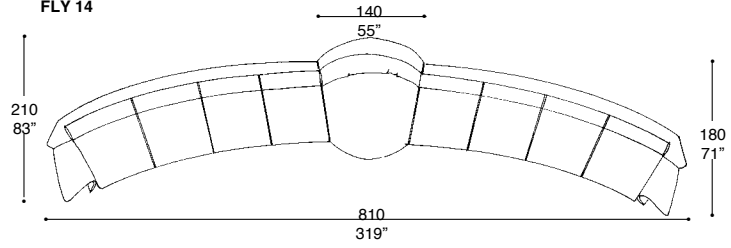

4 ▶

FLY 15

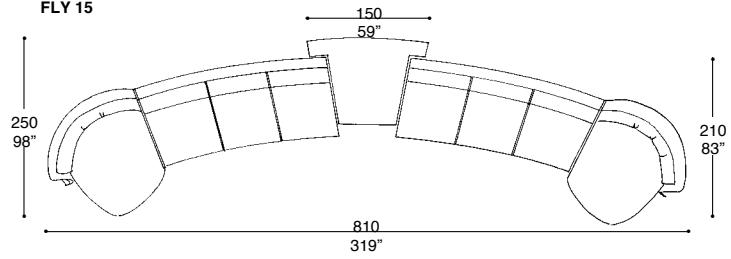

FLY

FLY 16

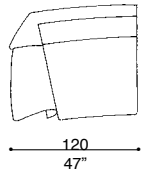

FLY 17

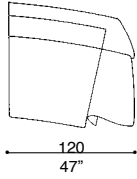

FLY 18

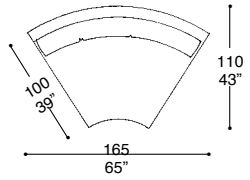

FLY 34

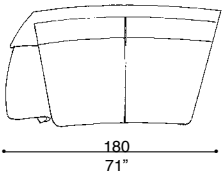

FLY 35

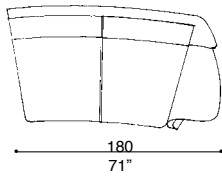

FLY 19

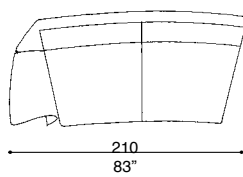

FLY 20

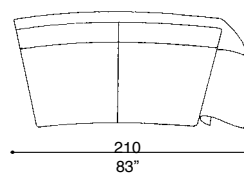

5 ▶

FLY 21

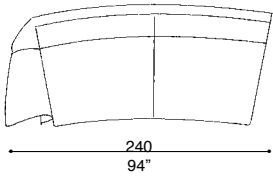

FLY 22

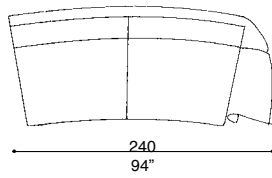

FLY 23

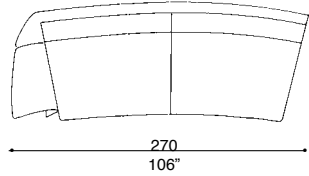

FLY 24

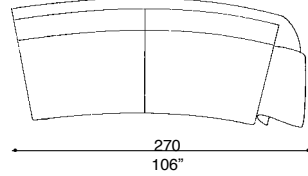

FLY

FLY 25

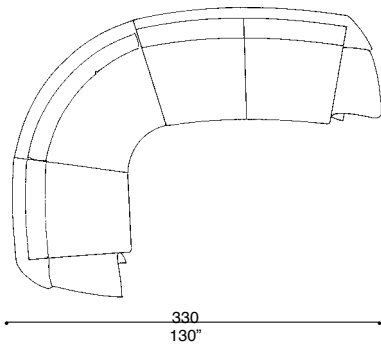

FLY 26

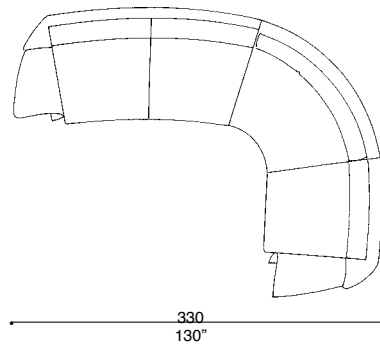

FLY 27

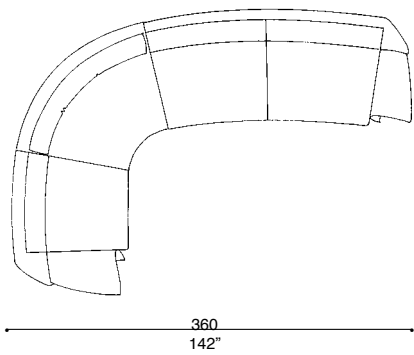

FLY 28

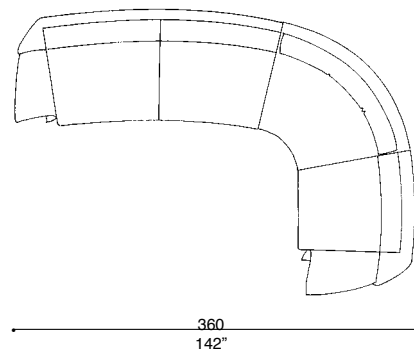

6 ▶

FLY 29

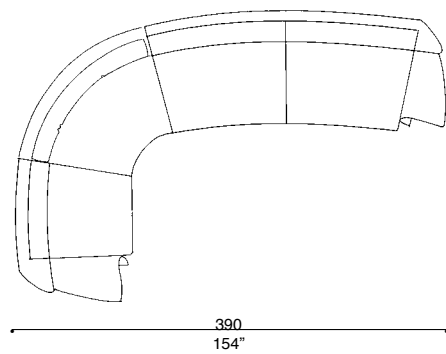

FLY 30

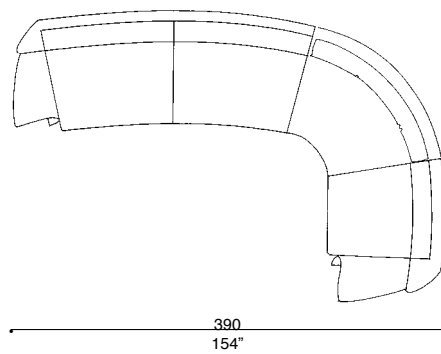

FLY

FLY 31

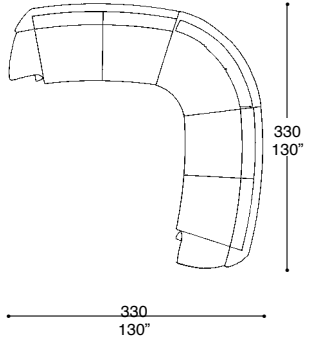

7 ▶

FLY 32

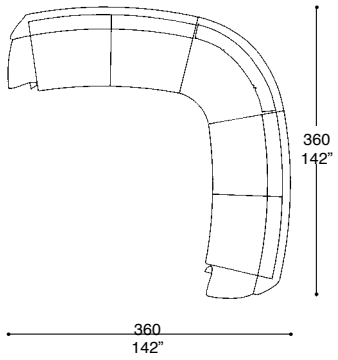

FLY 33

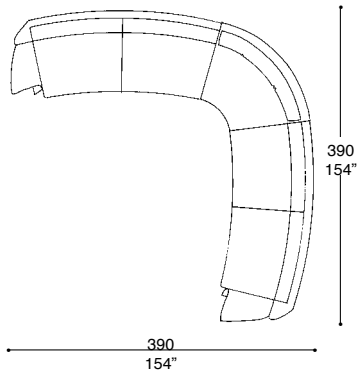

GALAXY

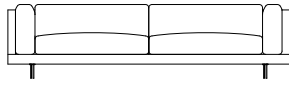
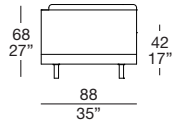

GA 00

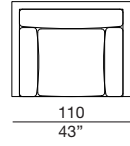

GA 01

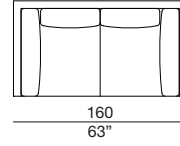

GA 02

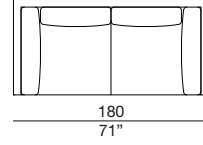

GA 03

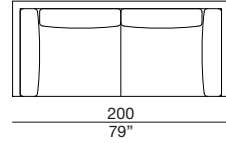

GA 04

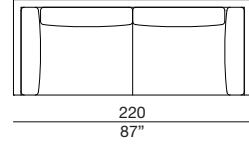

GA 05

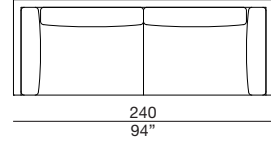

GA 06

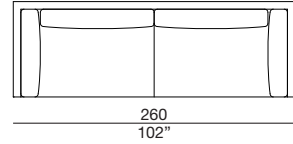

GA 07

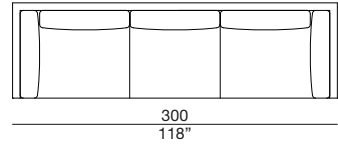

GALAXY

GA 08

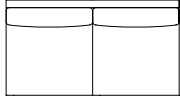

160
63"

GA 09

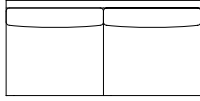

180
71"

GA 10

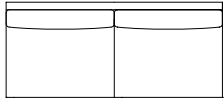

200
79"

GA 11

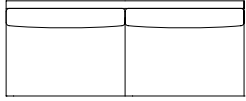

220
87"

GA 12

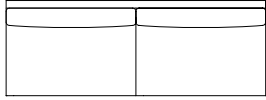

240
94"

GA 13

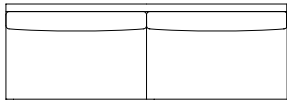

260
102"

GA 14

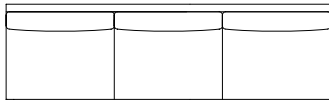

300
118"

2 ▶

GALAXY

GA 15

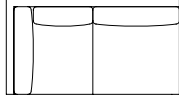

160
63"

GA 22

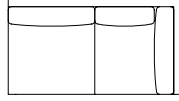

160
63"

GA 16

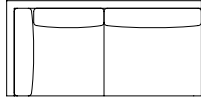

180
71"

GA 23

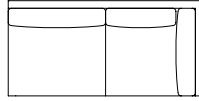

180
71"

GA 17

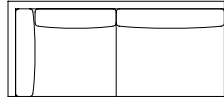

200
79"

GA 24

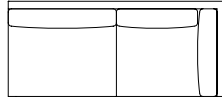

200
79"

GA 18

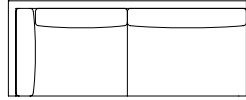

220
87"

GA 25

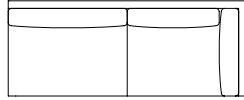

220
87"

GA 19

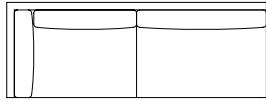

240
94"

GA 26

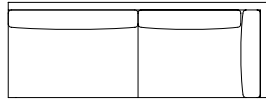

240
94"

GA 20

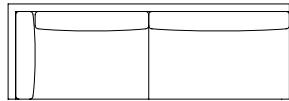

260
102"

GA 27

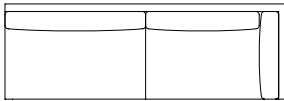

260
102"

GA 21

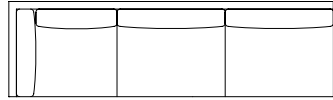

300
118"

GA 28

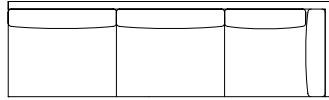

300
118"

GALAXY

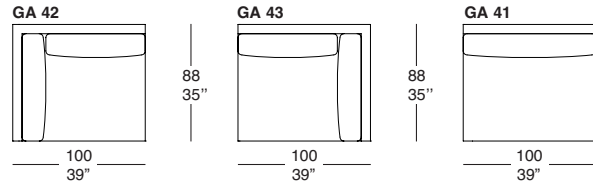
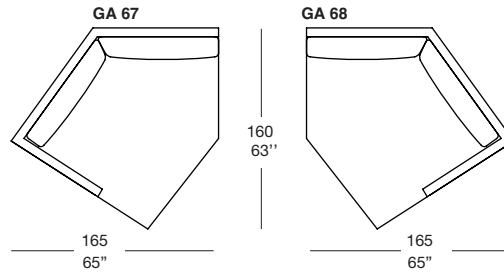
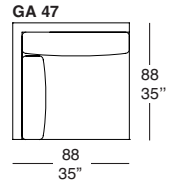

4 ▶

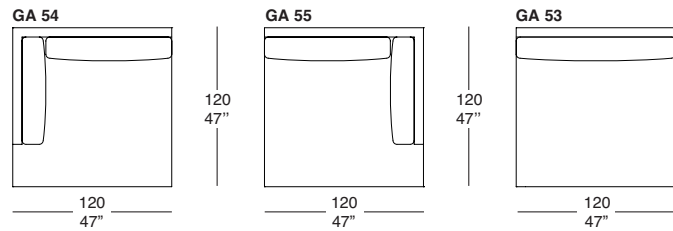
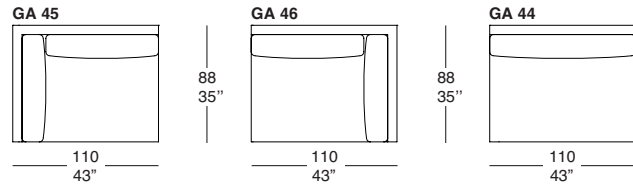

GALAXY

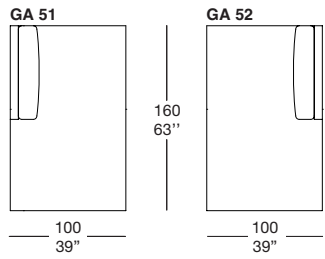
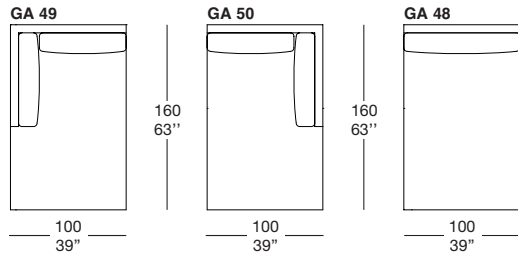

5 ▶

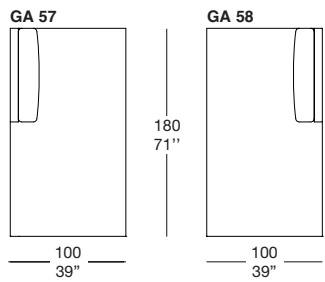
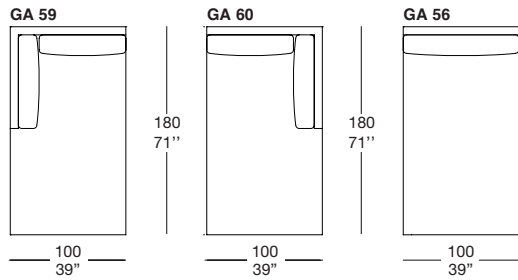

GALAXY

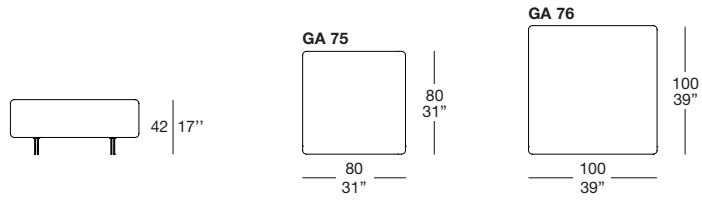

6 ▶

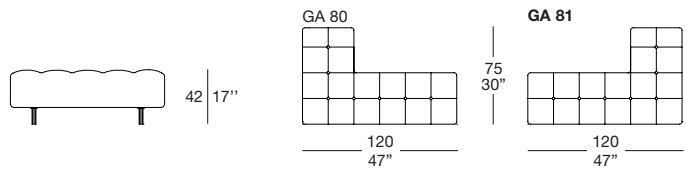
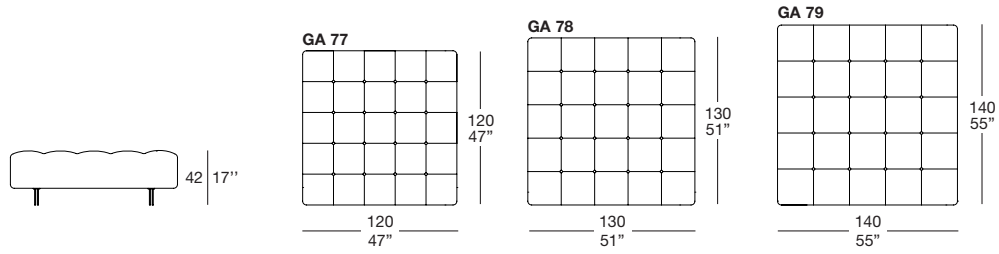

GALAXY

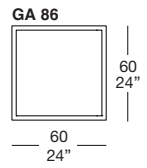
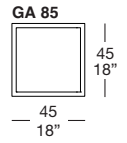
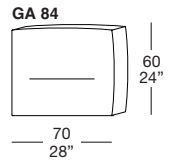

7 ▶

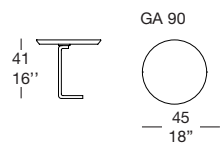
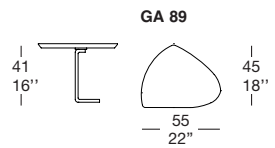
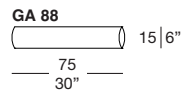
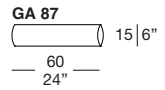

GALAXY

GA 91

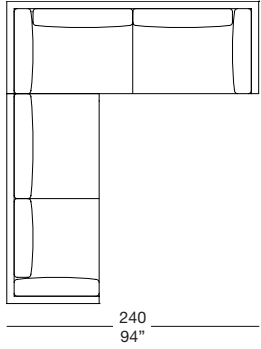

GA 92

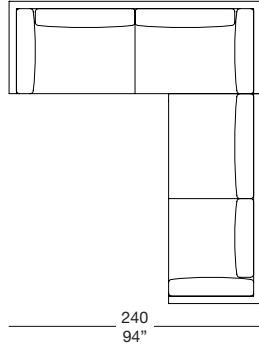

288
113"

240
94"

240
94"

GA 93

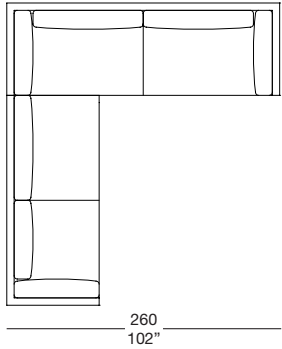

GA 94

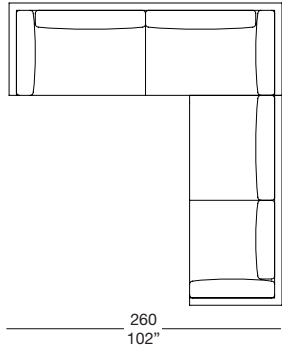

288
113"

260
102"

260
102"

GA 95

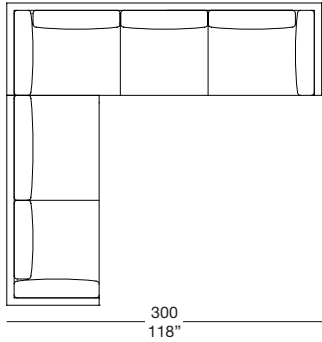

GA 96

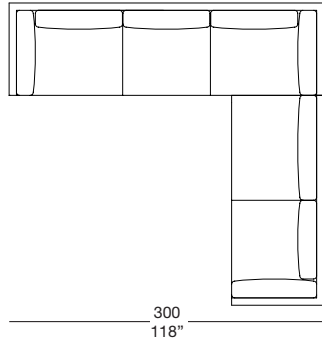

288
113"

300
118"

300
118"

GALAXY

GA 97

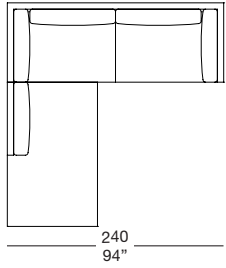

GA 98

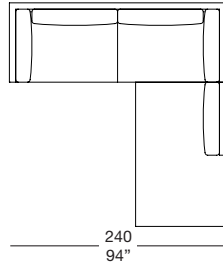

GA 99

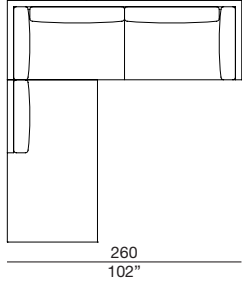

GA 100

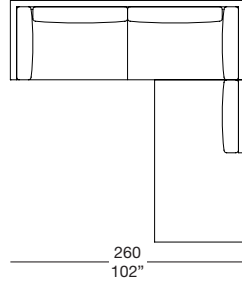

GA 101

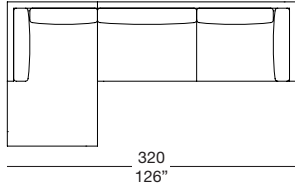

GA 102

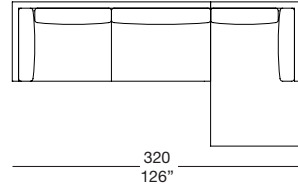

GA 103

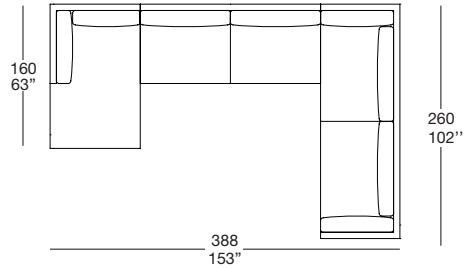

GA 104

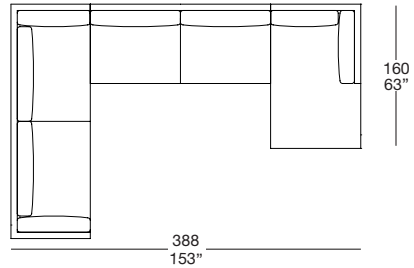

GALAXY

GA 105

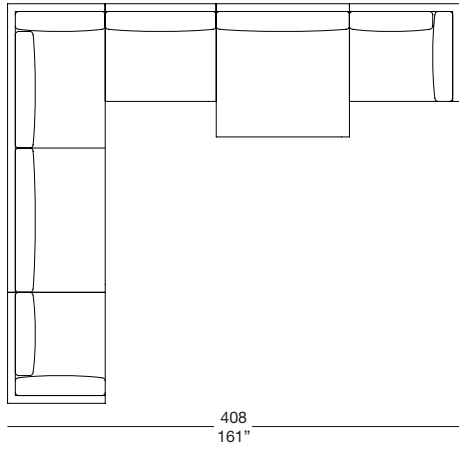

GA 106

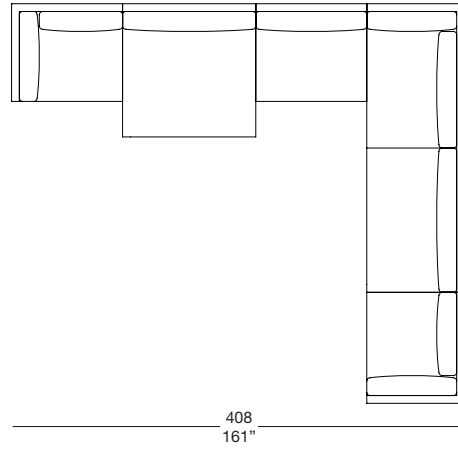

10 ►

GA 107

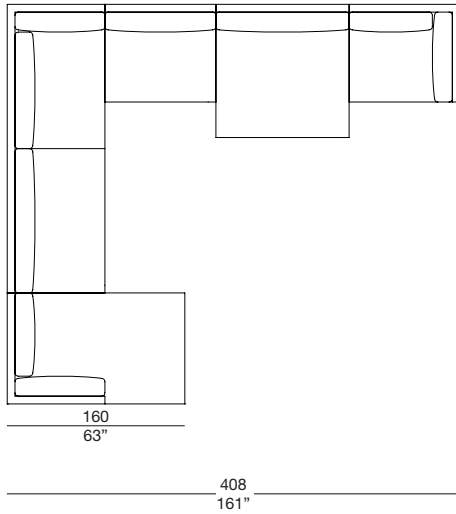

GA 108

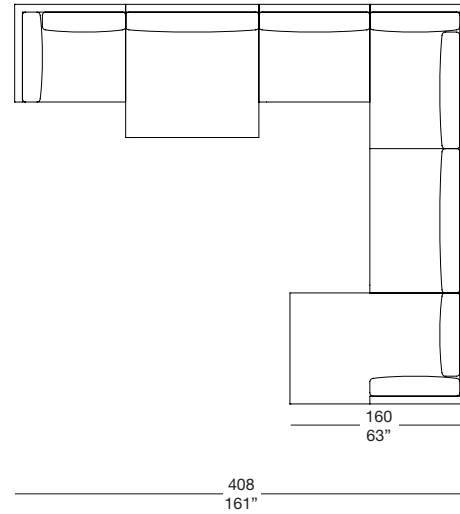

GALAXY

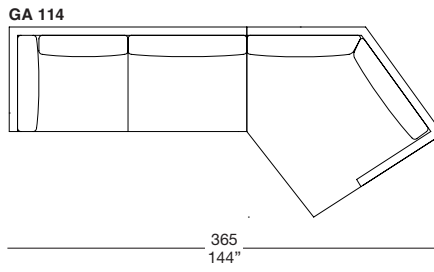
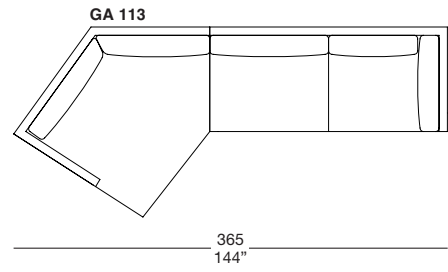

GLOBE

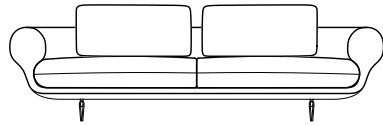
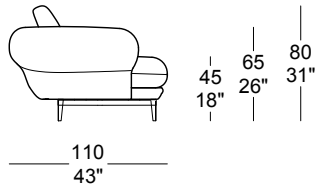

GLO 01

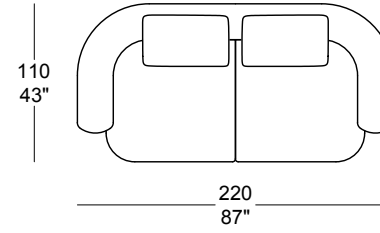

GLO 02

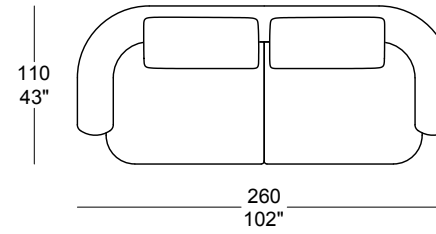

1 ▶

GLO 04

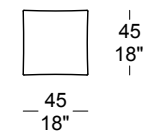

GLO 05

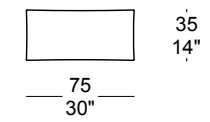

MARKUS

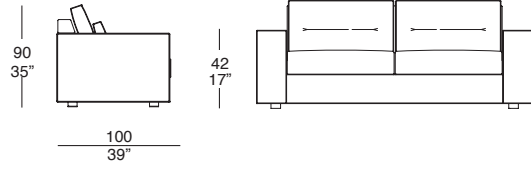

MA30

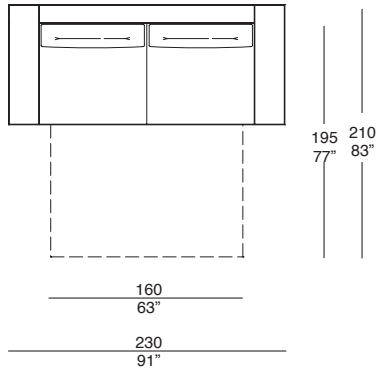

1 ▶

MA31

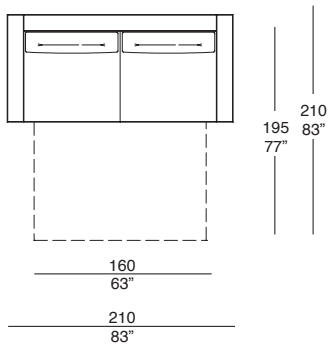

MERCURY LINE

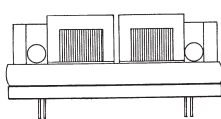
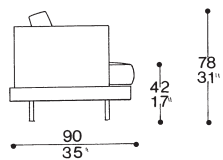

ML 01

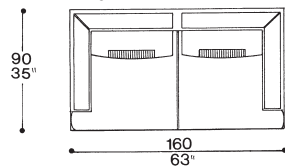

ML 02

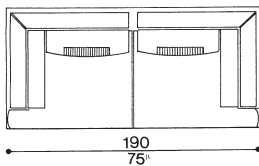

ML 03

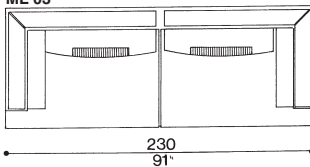

ML 04

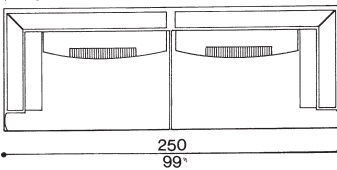

ML 05

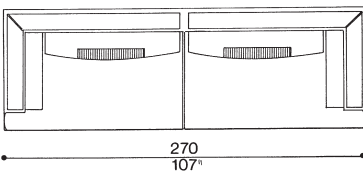

MERCURY LINE

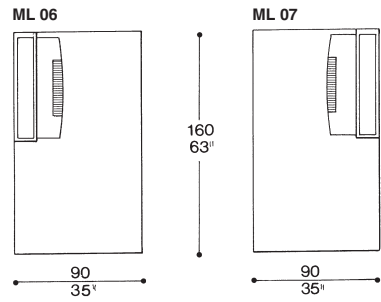

2 ▶

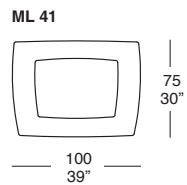
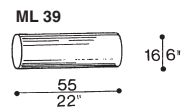
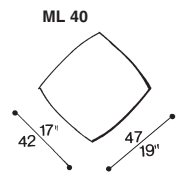
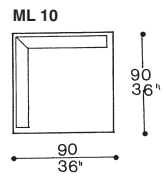
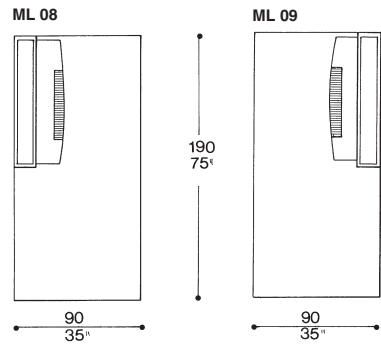

MERCURY LINE

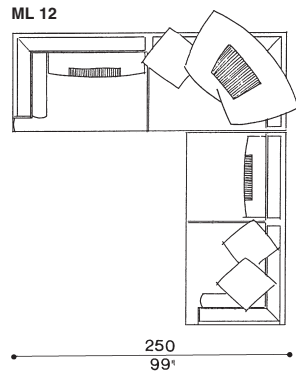
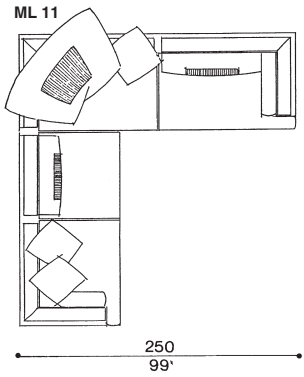

3 ▶

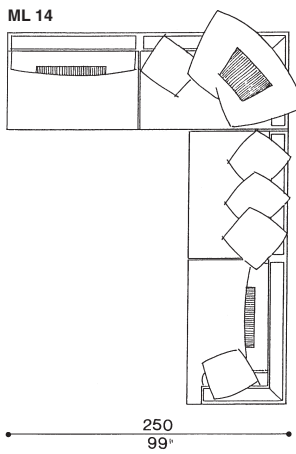
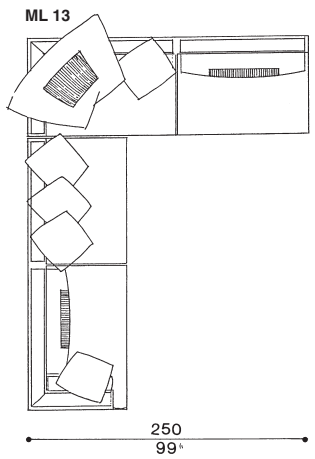

MERCURY LINE

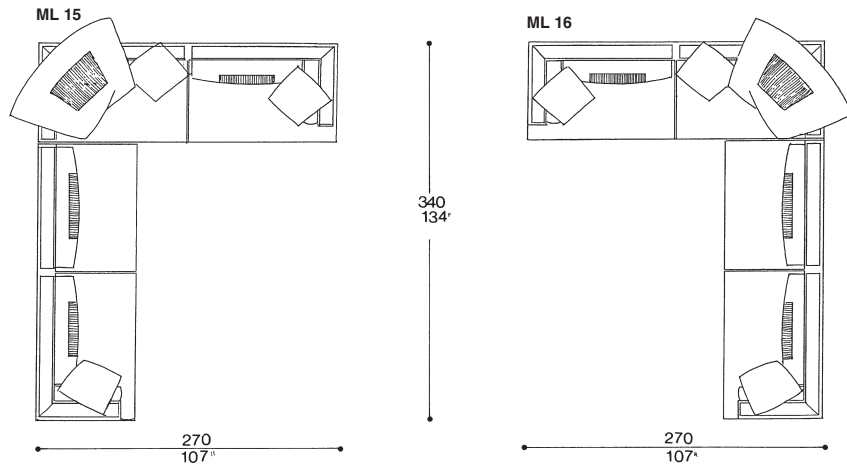

4 ▶

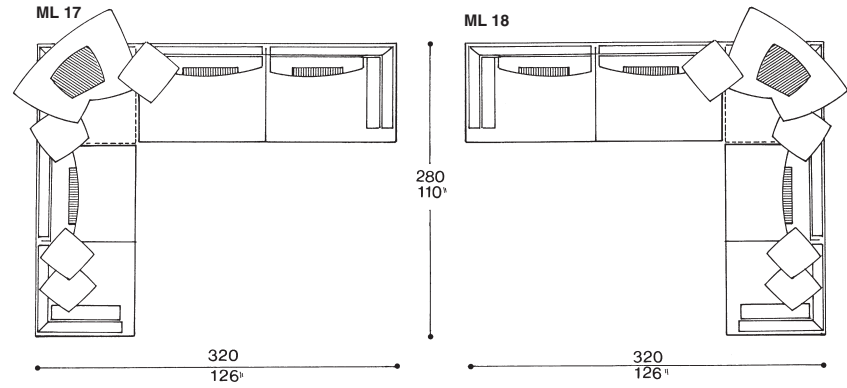

MERCURY LINE

ML 19

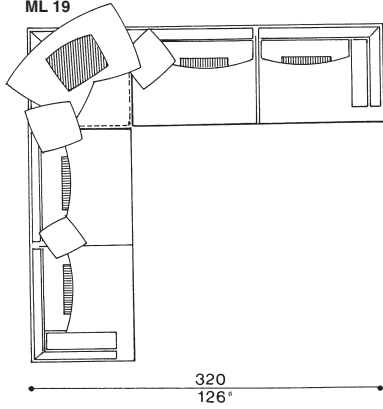

320
126"

ML 20

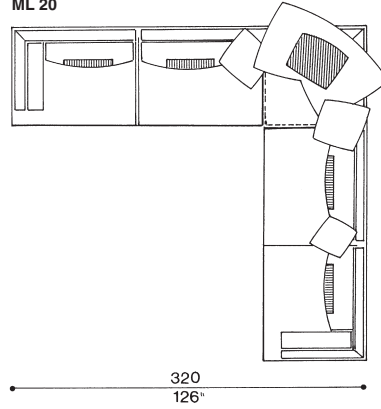

320
126"

ML 21

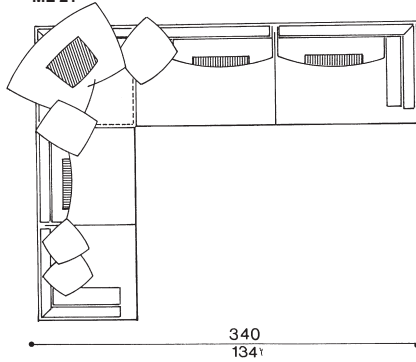

340
134"

ML 22

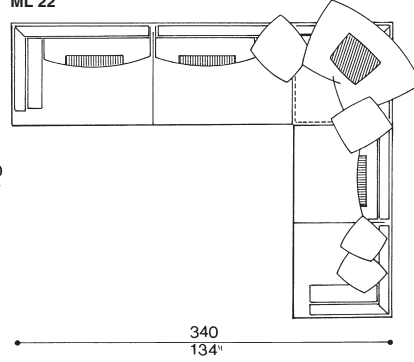

340
134"

ML 23

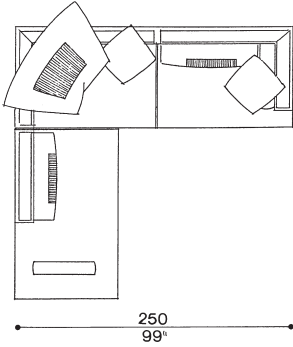

250
99"

250
99"

ML 24

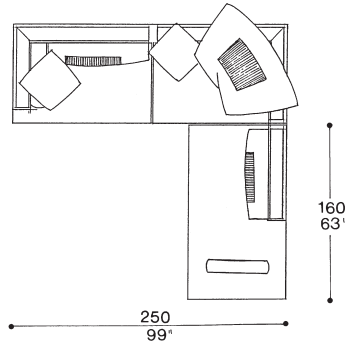

250
99"

160
63"

MERCURY LINE

ML 25

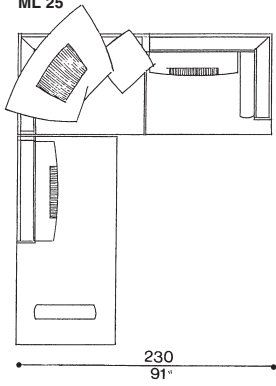

ML 26

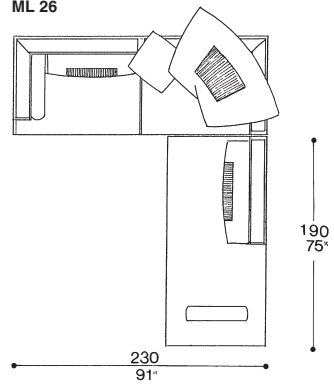

ML 27

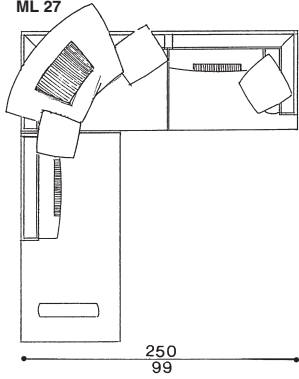

ML 28

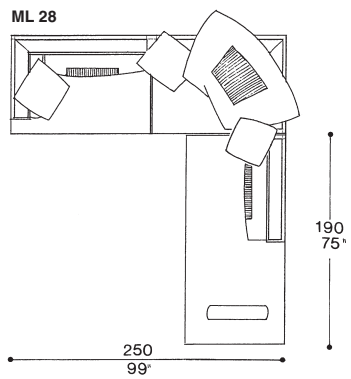

ML 29

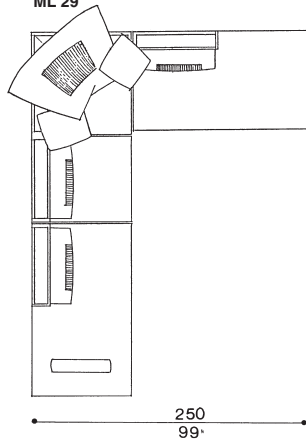

ML 30

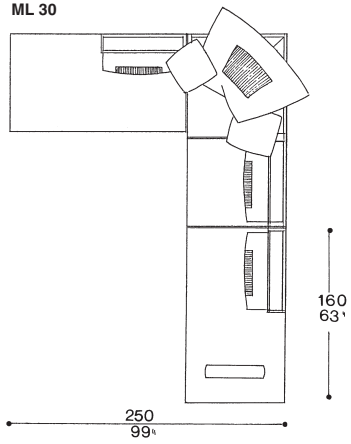

MERCURY LINE

ML 31

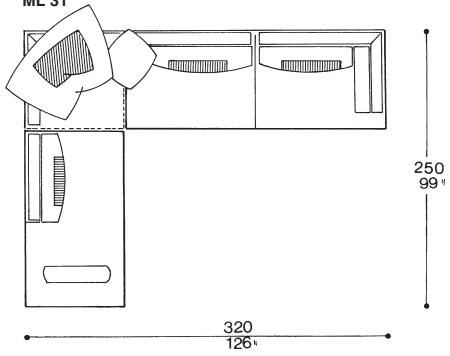

ML 32

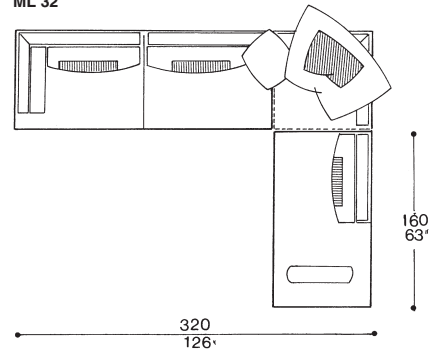

ML 33

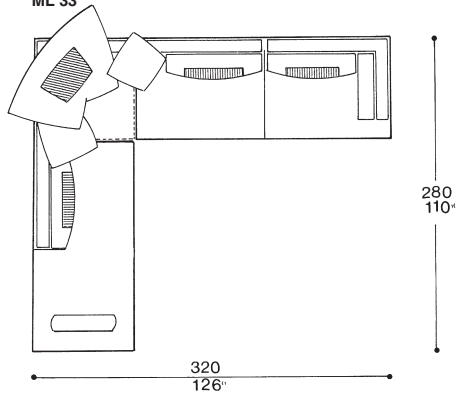

ML 34

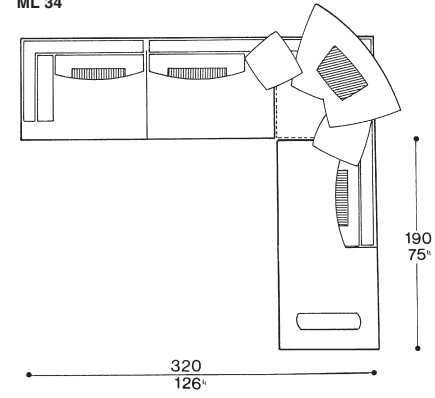

7 ▶

ML 35

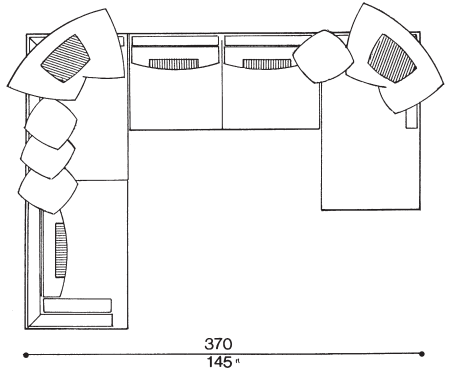

ML 36

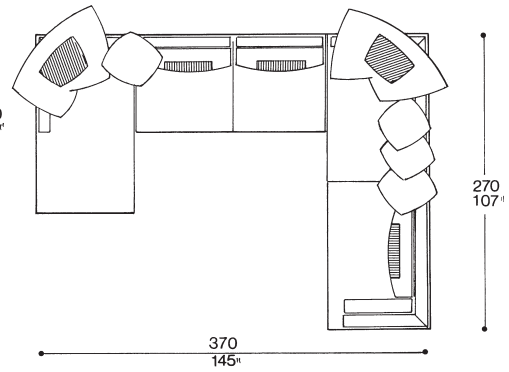

MERCURY LINE

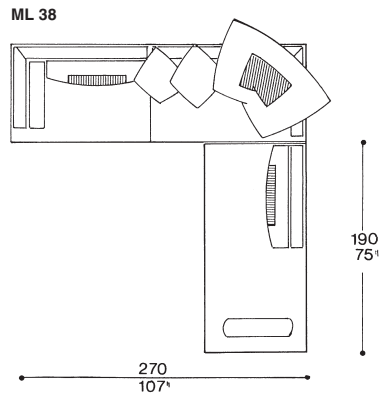
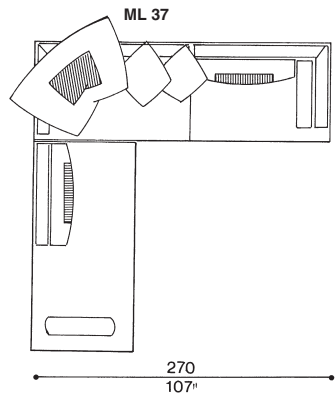

8 ▶

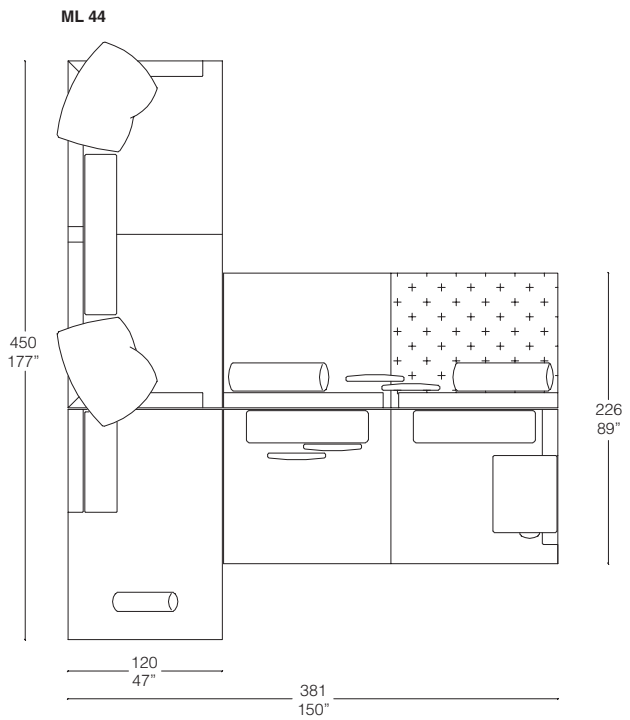

MERCURY SOFT

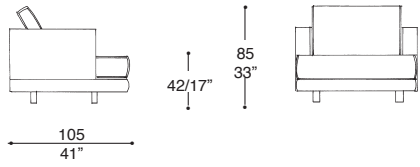

MS 01

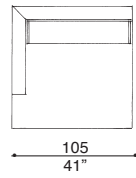

MS 02

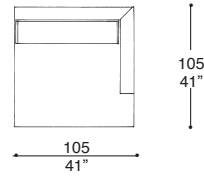

MS 03

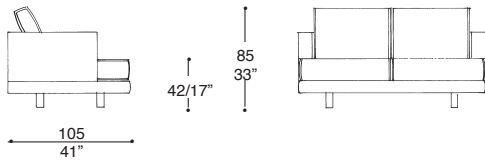
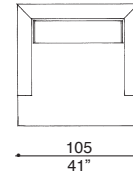

MS 04

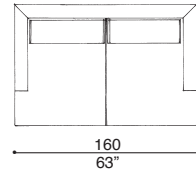

MS 05

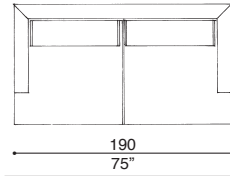

MS 06

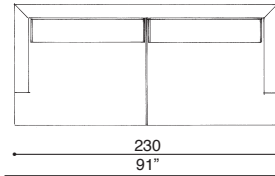

MS 07

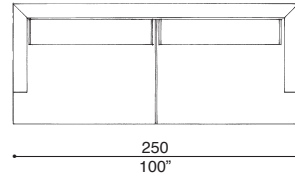

MS 08

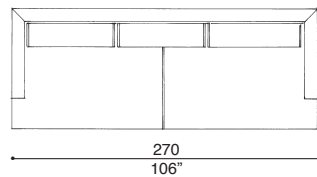

MERCURY SOFT

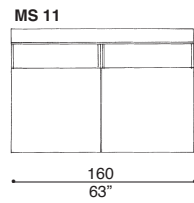
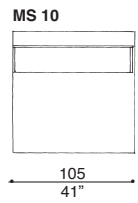
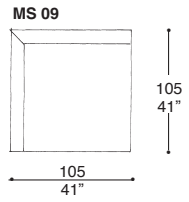

2 ▶

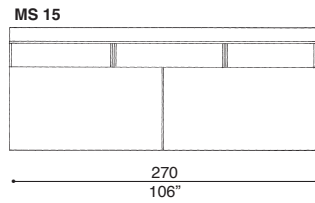
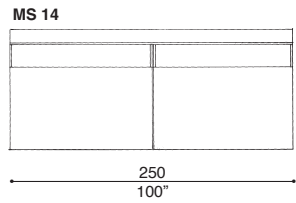
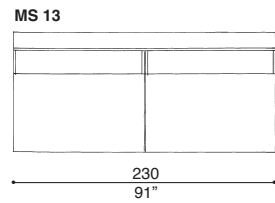
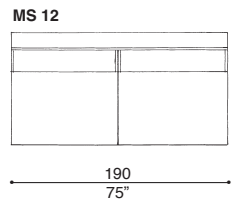

MERCURY SOFT

MS 16

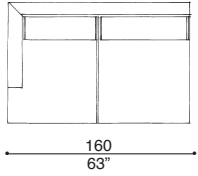

MS 21

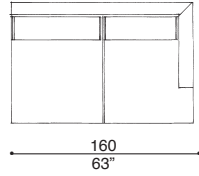

MS 17

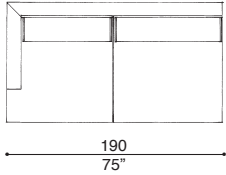

MS 22

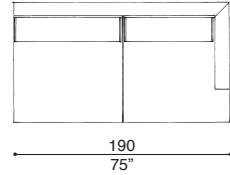

MS 18

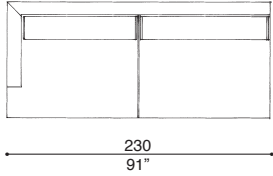

MS 23

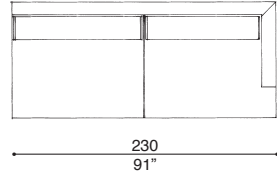

MS 19

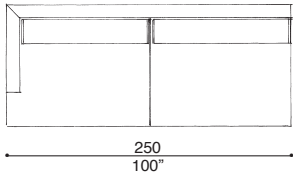

MS 24

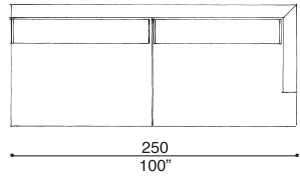

MS 20

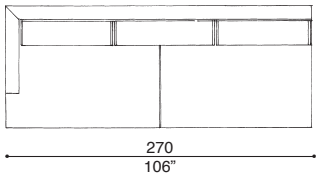

MS 25

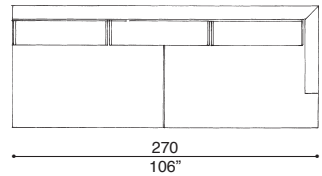

MERCURY SOFT

MS 26

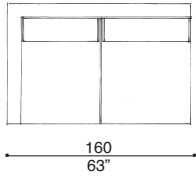

MS 31

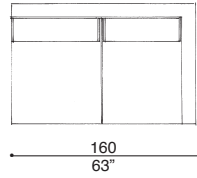

MS 27

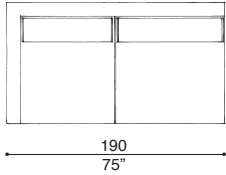

MS 32

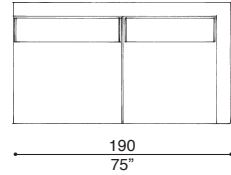

MS 28

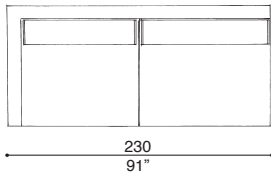

MS 33

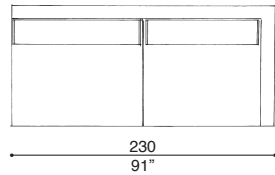

MS 29

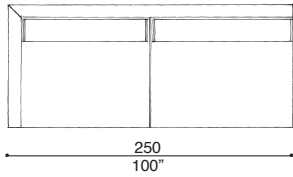

MS 34

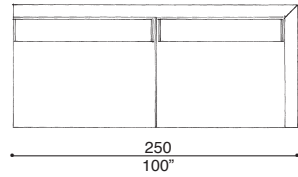

MS 30

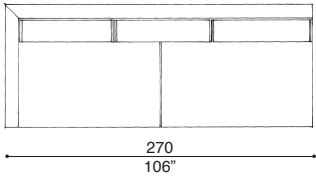

MS 35

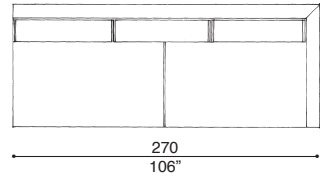

MERCURY SOFT

MS 36

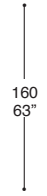
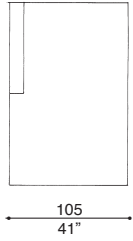

MS 37

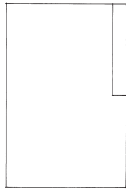

MS 38

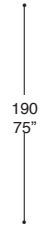
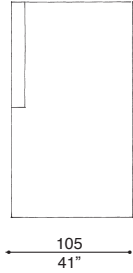

MS 39



5 ▶

MS 40

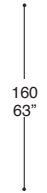
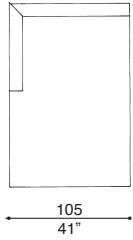

MS 41

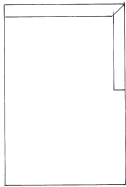

MS 42

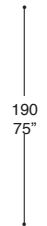
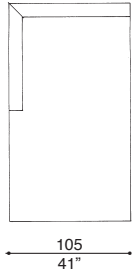

MS 43

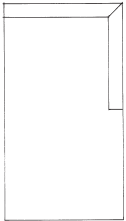

MERCURY SOFT

MS 44

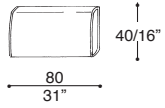

MS 45

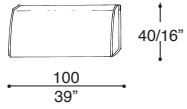

MS 46

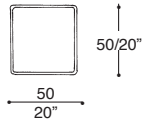

MS 47

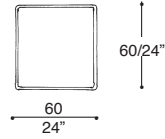

MS 48

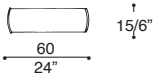

6 ▶

MS 49

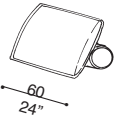

MS 50

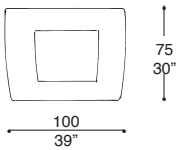

MS 85

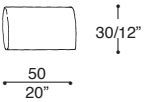

MS 86

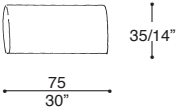

MERCURY SOFT

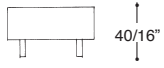

MS 53 "A"

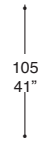

MS 54 "B"

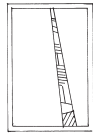

MS 55 "C"

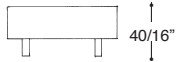

MS 56 "A"

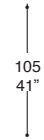
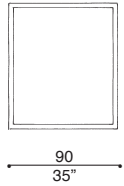

MS 57 "B"

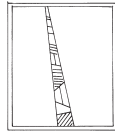

MS 58 "C"

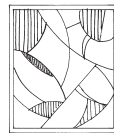

7 ▶

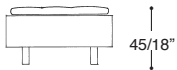

MS 59

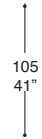
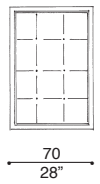

MS 60

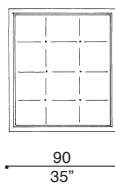

MS 61

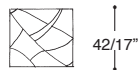
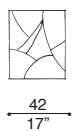

MERCURY SOFT

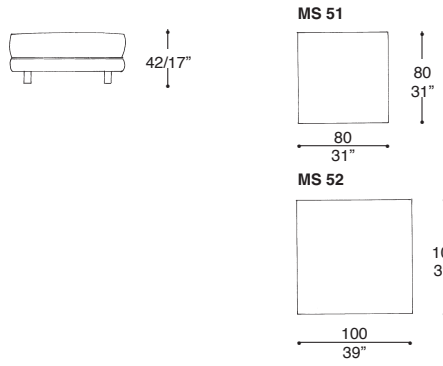

8 ▶

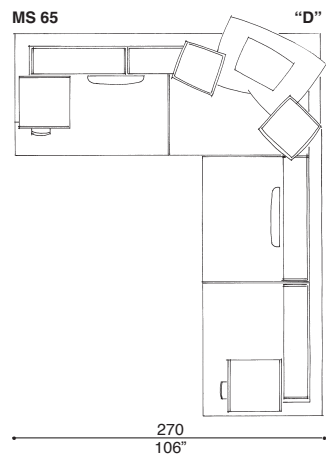
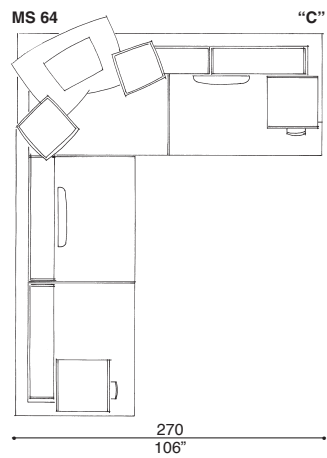
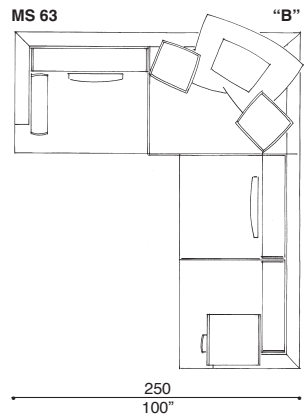
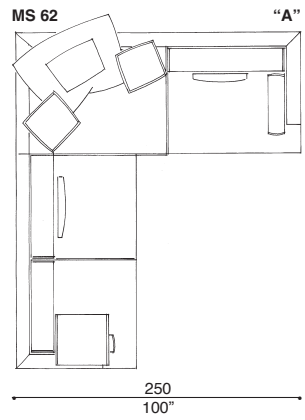

MERCURY SOFT

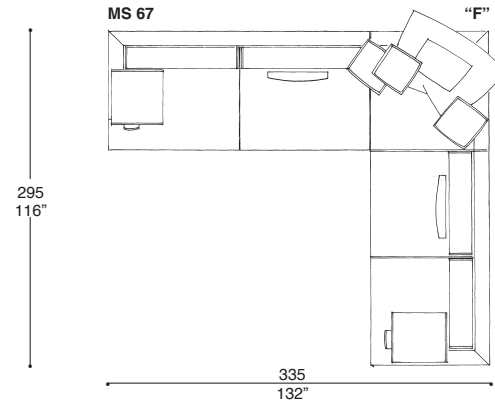
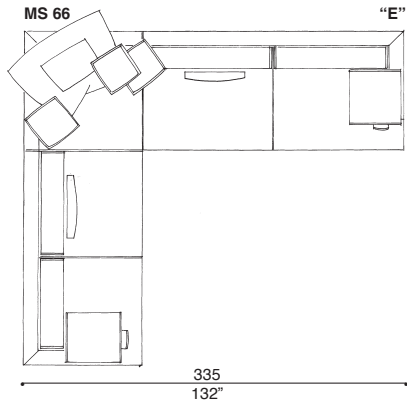

295
116"

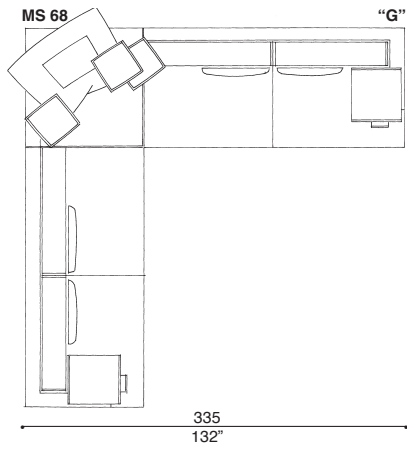

335
132"

9 ▶

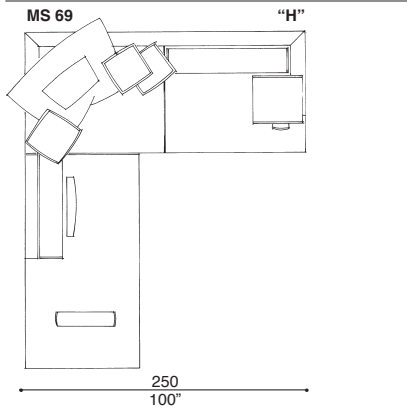

295
116"

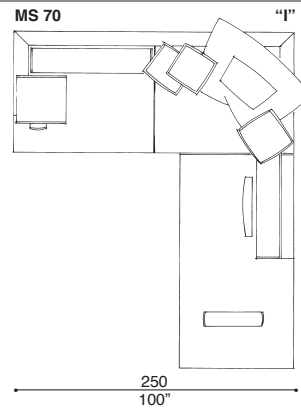

MERCURY SOFT

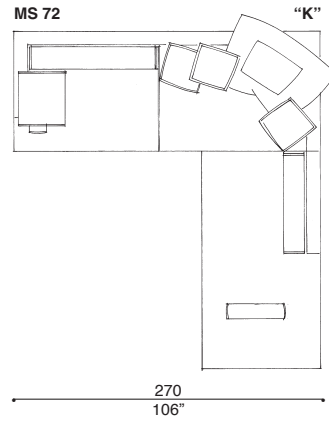
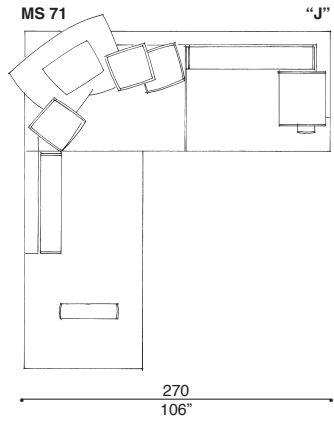

10 ►

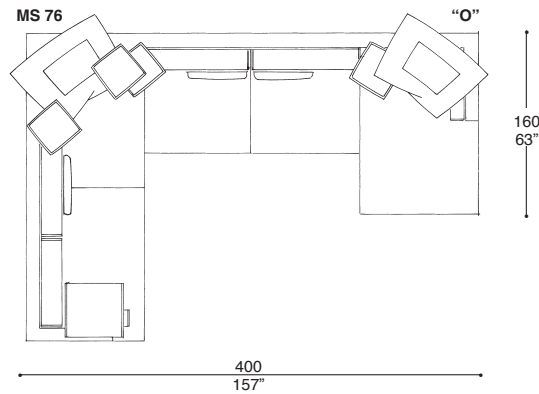
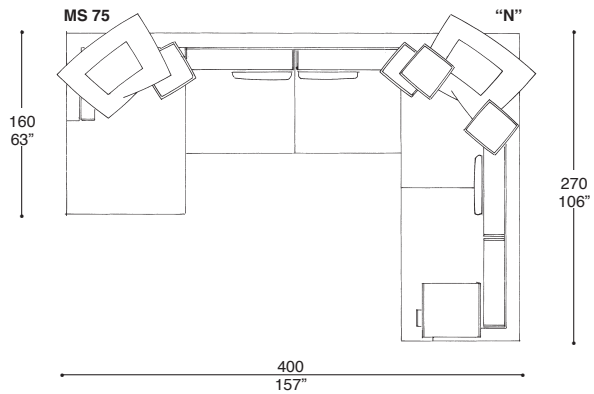
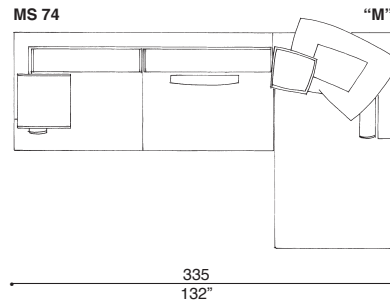
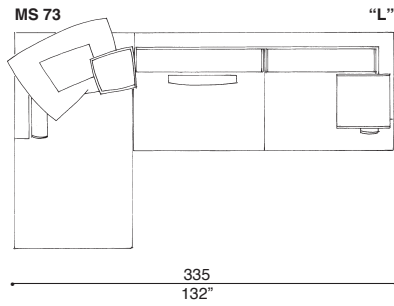

MERCURY SOFT

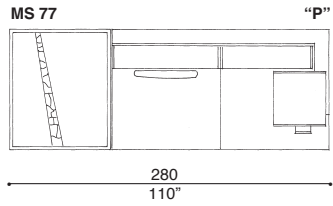

105
41"

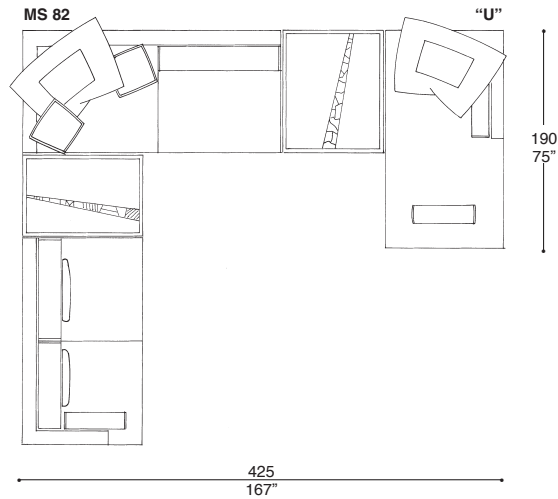
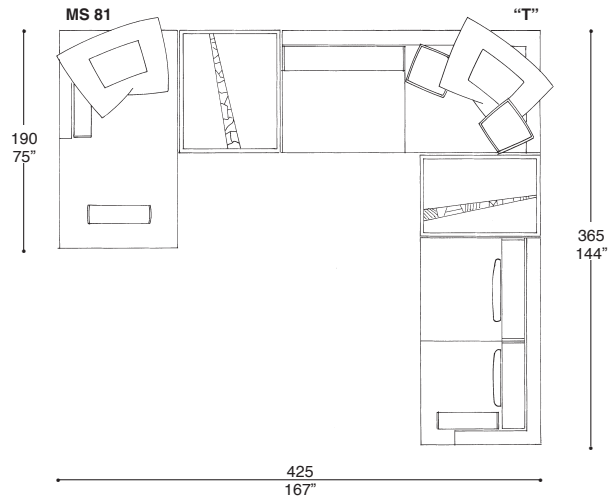
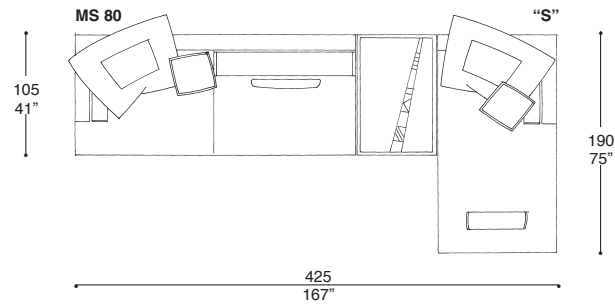
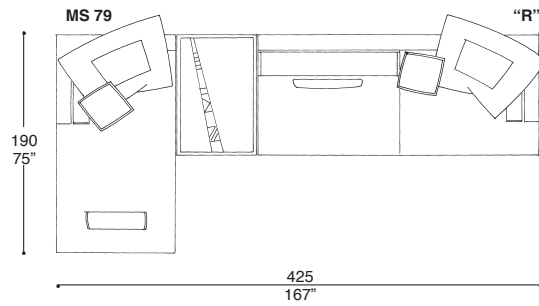
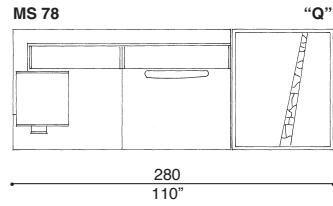

MERCURY SOFT

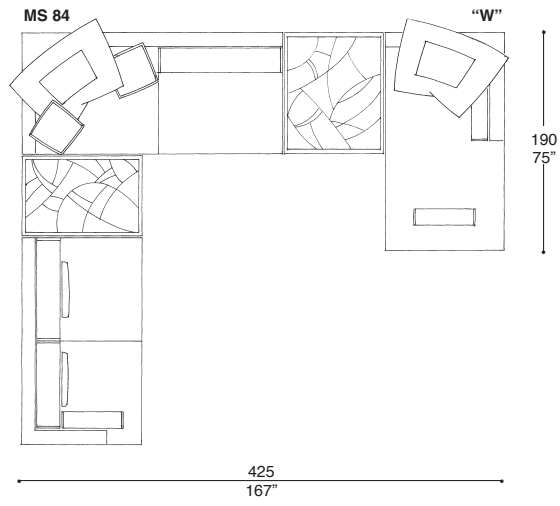
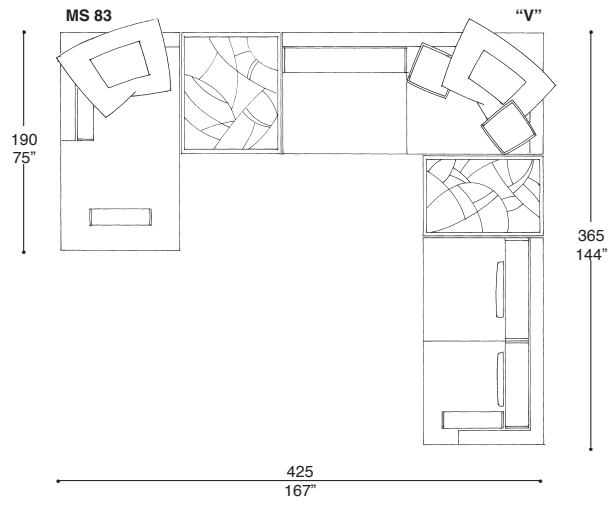

12 ▶

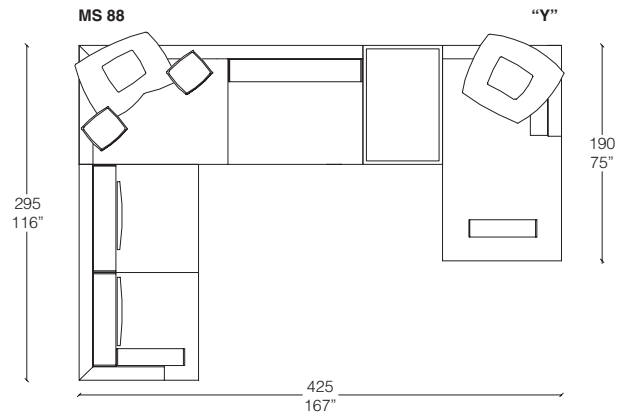
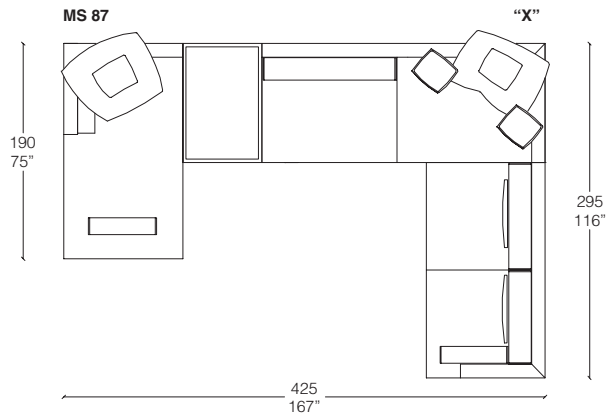

MERCURY SOFT

MS89 "AA"

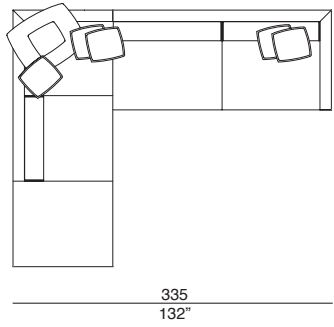

MS90 "BB"

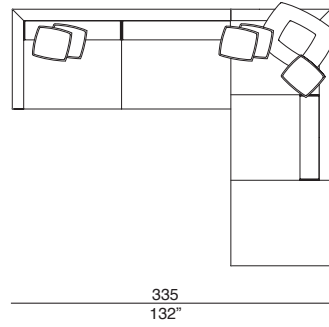

270
106"

13 ▶

MS91 "CC"

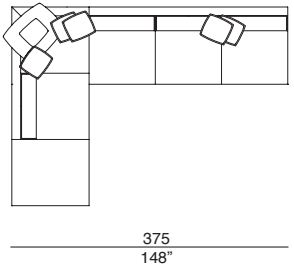

MS92 "DD"

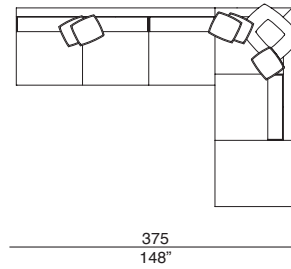

270
106"

MS93 "EE"

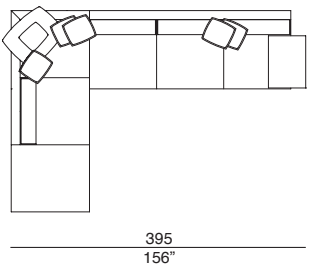

MS94 "FF"

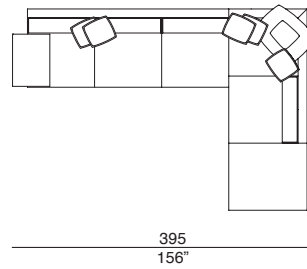

270
106"

MERCURY SOFT

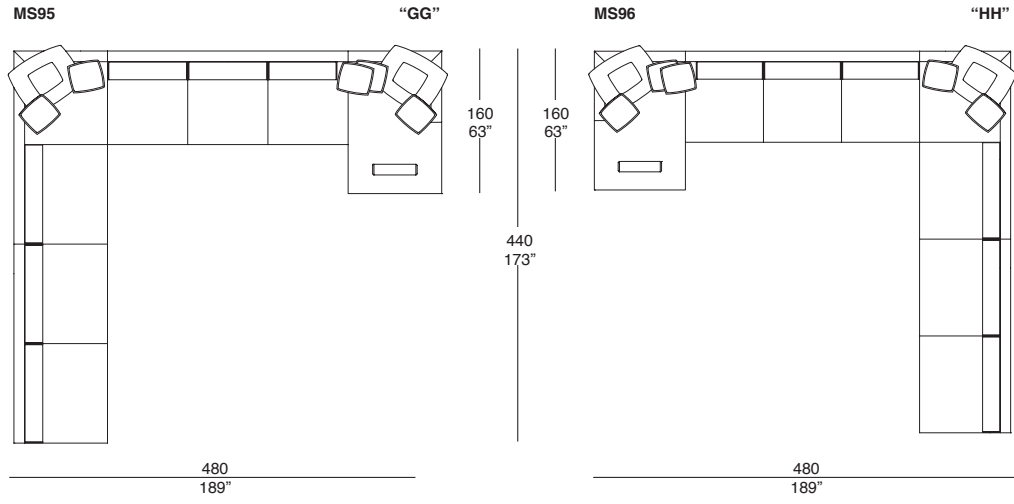

MET

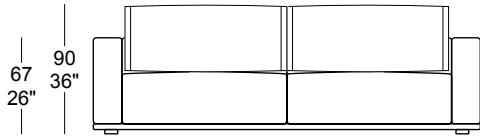
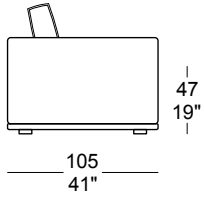

MET 01

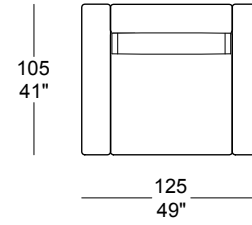

MET 02

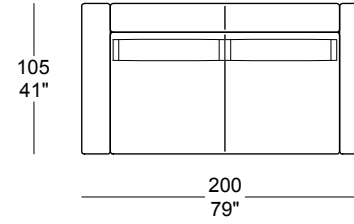

MET 03

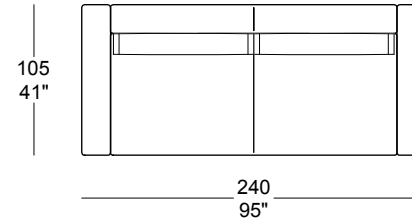

MET 04

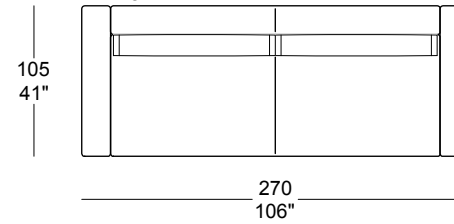

MET

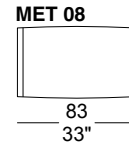
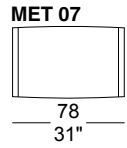
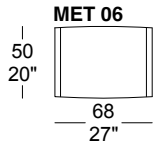
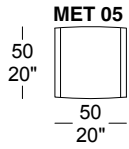

2 ▶

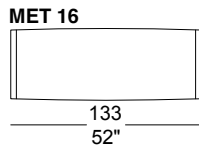
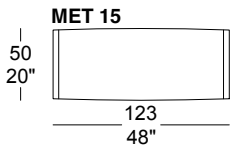
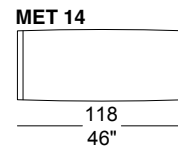
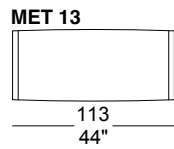
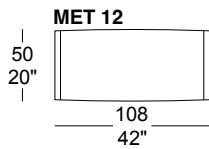
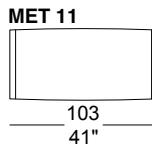
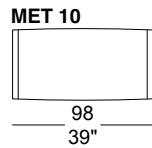
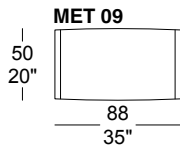

MET

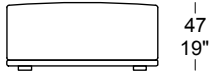

MET 22

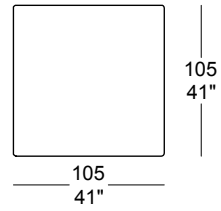

MET 23

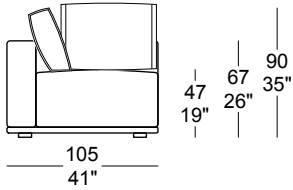
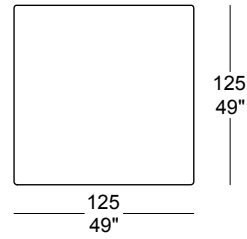

MET 24

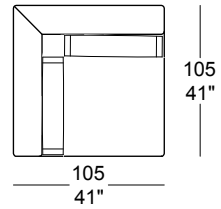

MET 95

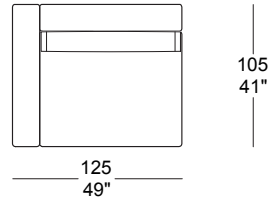

MET 96

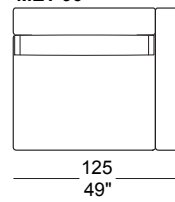

MET

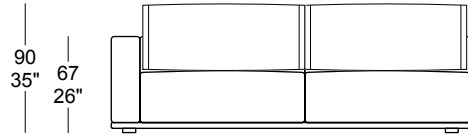
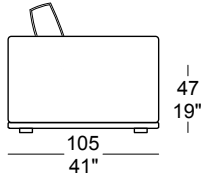

MET 25

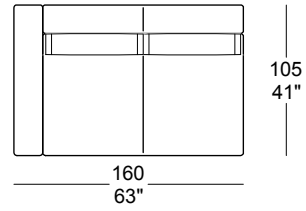

MET 29

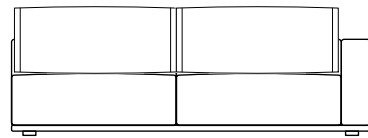
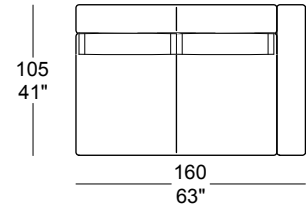

MET 26

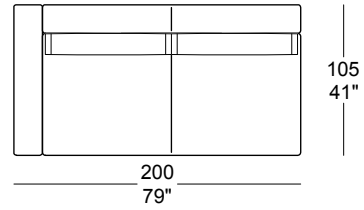

MET 30

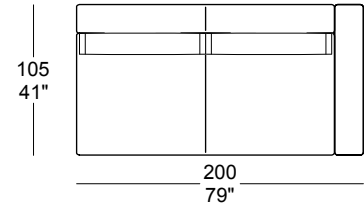

4 ▶

MET 27

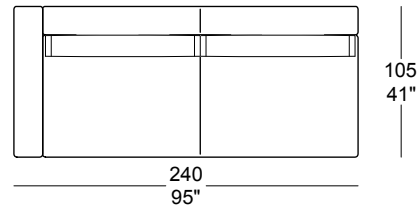

MET 31

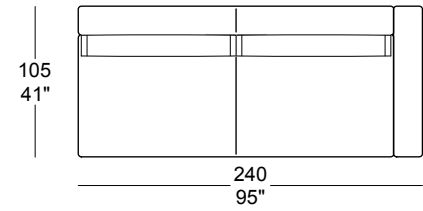

MET 28

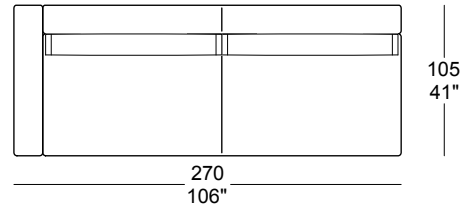

MET 32

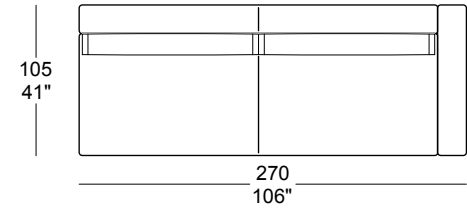

MET

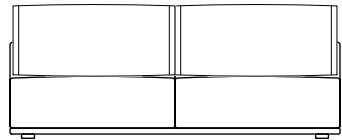
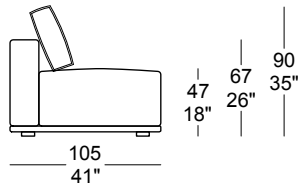

5 ▶

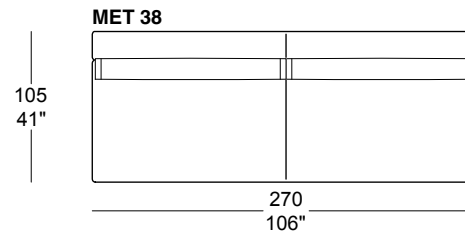
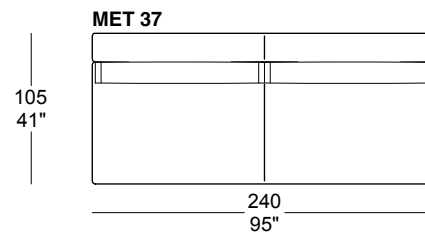
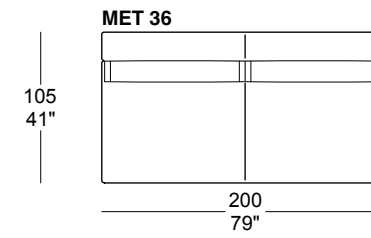
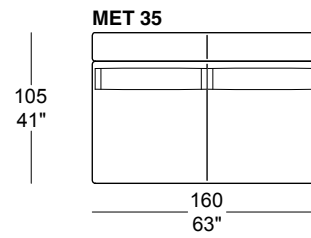
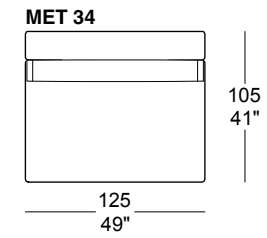
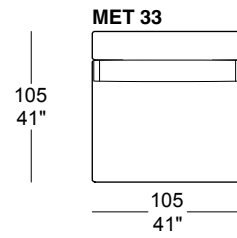

MET

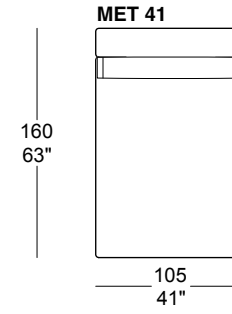
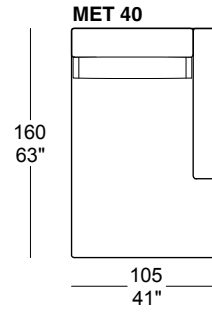
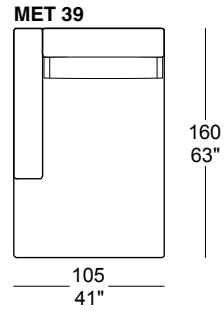
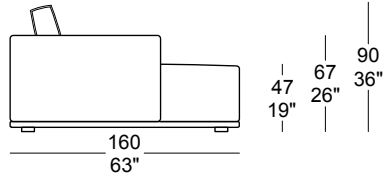

6 ▶

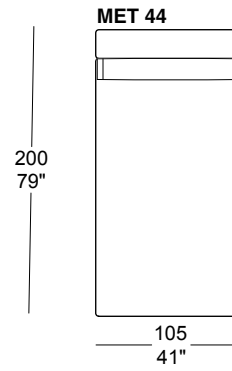
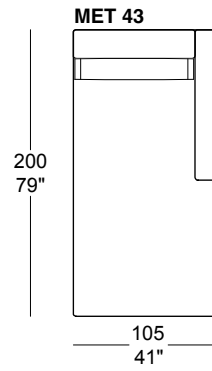
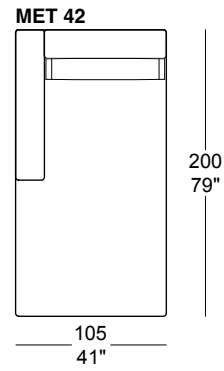
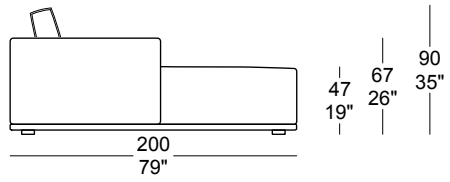

MET

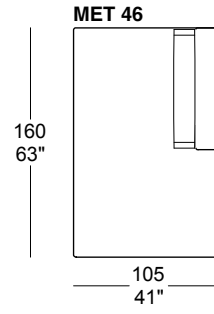
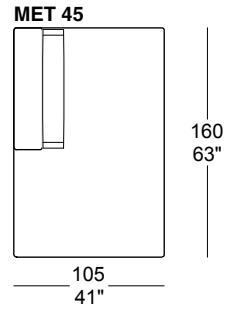
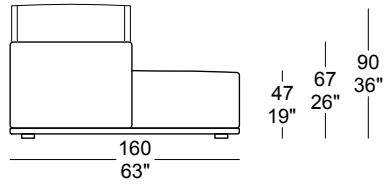

7 ▶

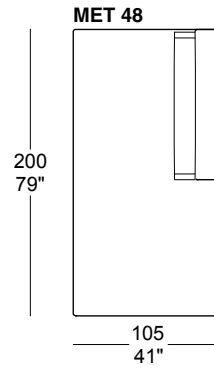
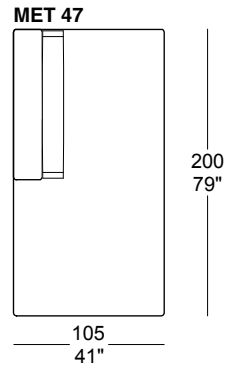
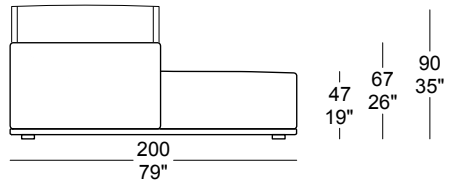

MET

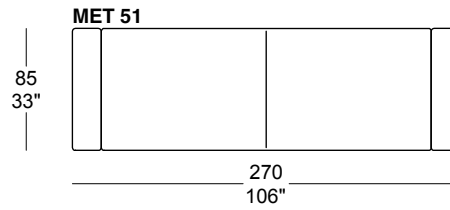
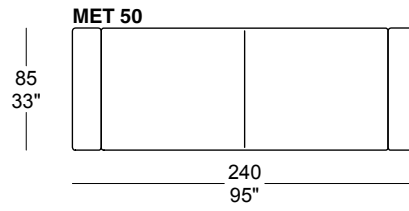
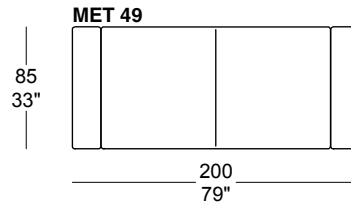
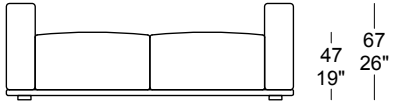

MET

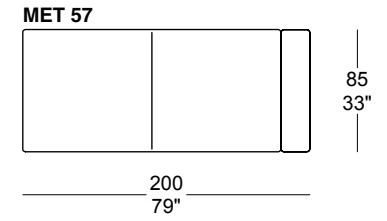
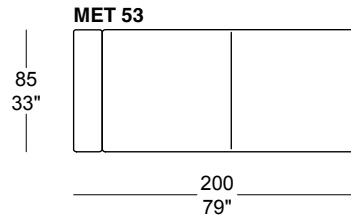
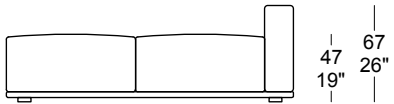
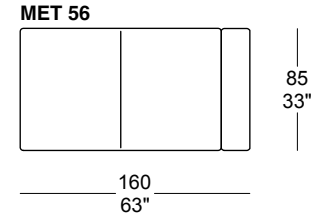
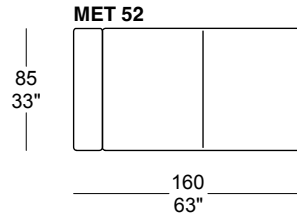
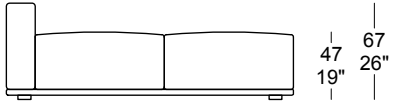

9 ▶

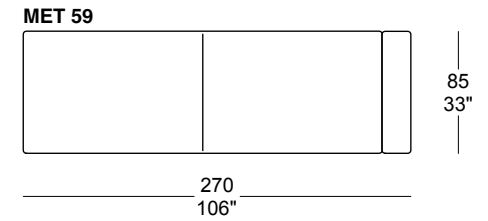
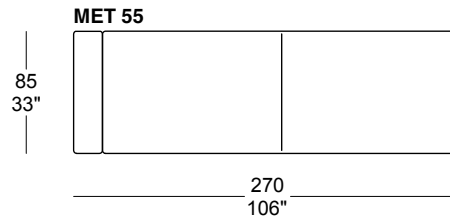
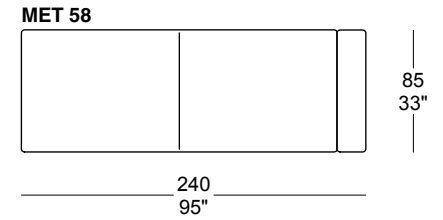
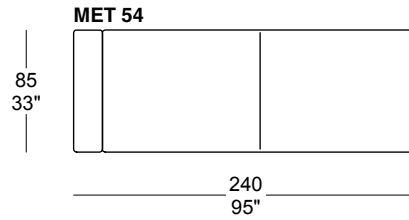

MET

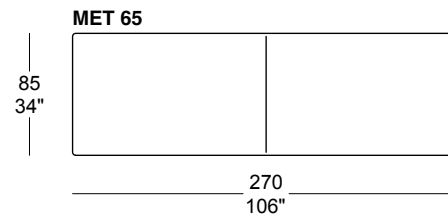
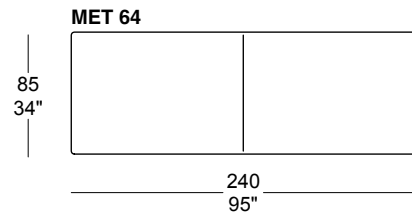
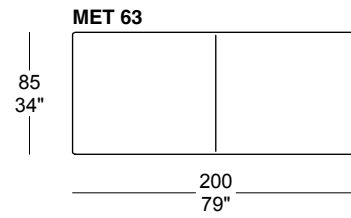
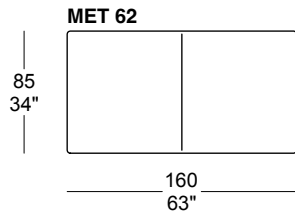
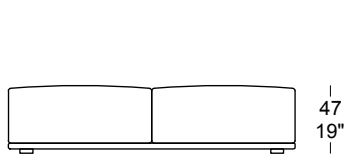
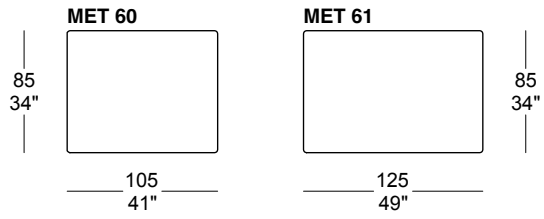

MET

MET 66

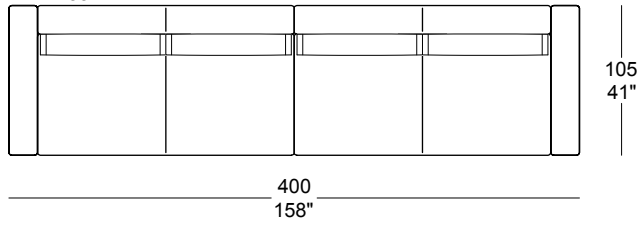

MET 67

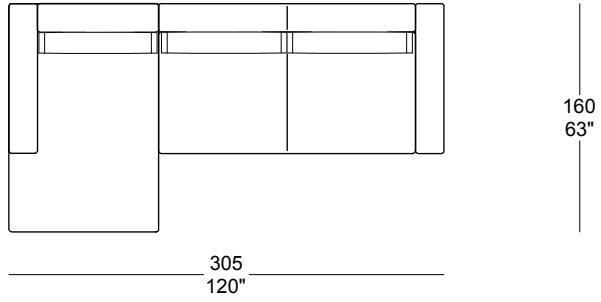

MET 68

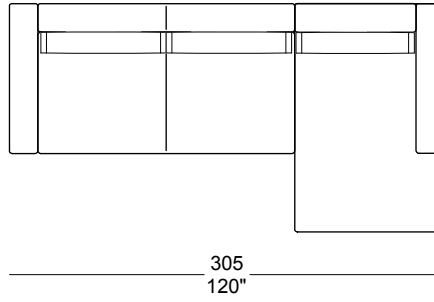

MET 69

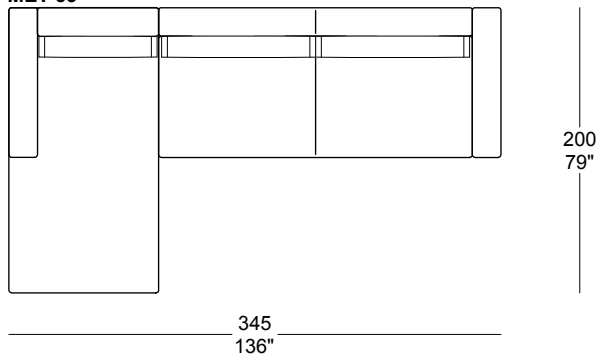

MET 70

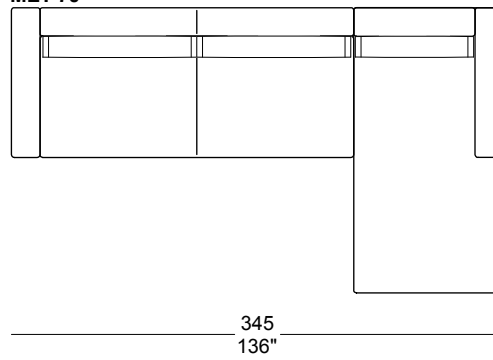

MET

MET 71

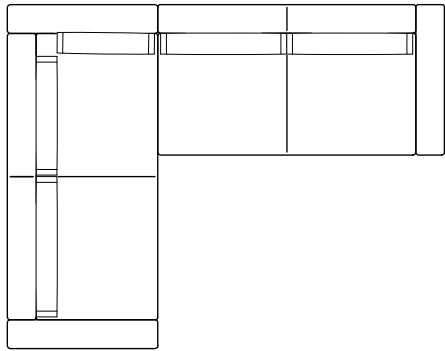

240
95"

305
120"

MET 72

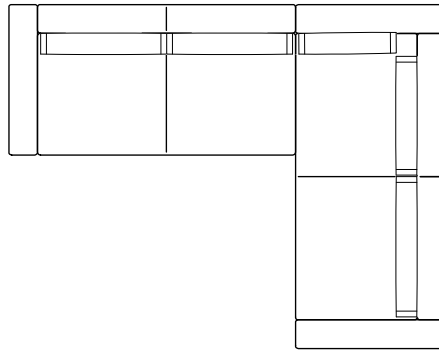

305
120"

12 ▶

MET 73

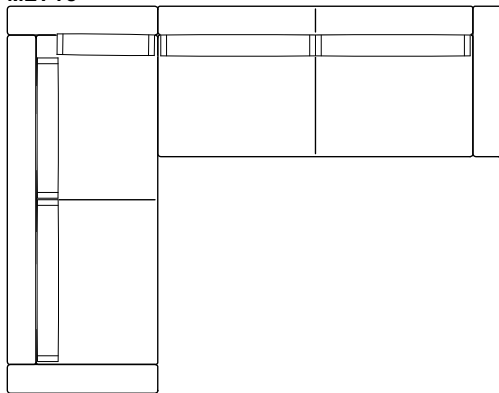

270
106"

345
136"

MET 74

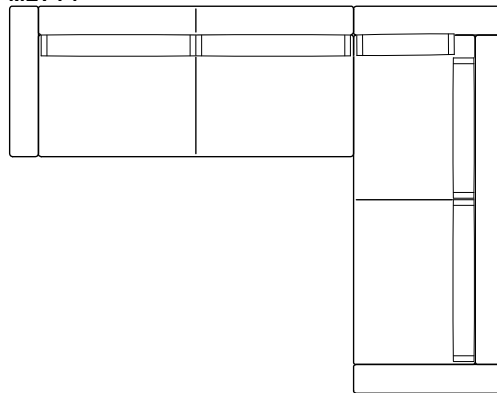

345
136"

MET

MET 75

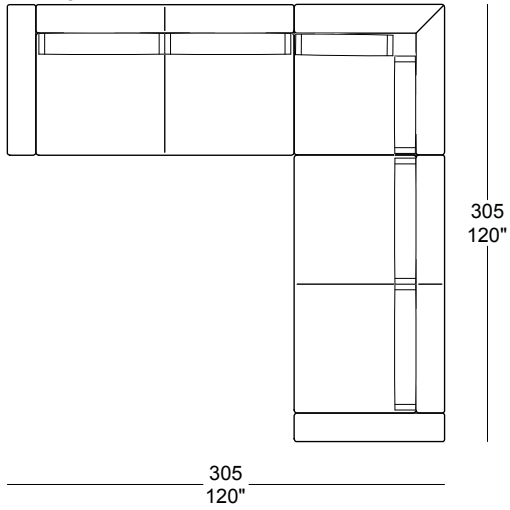

MET 76

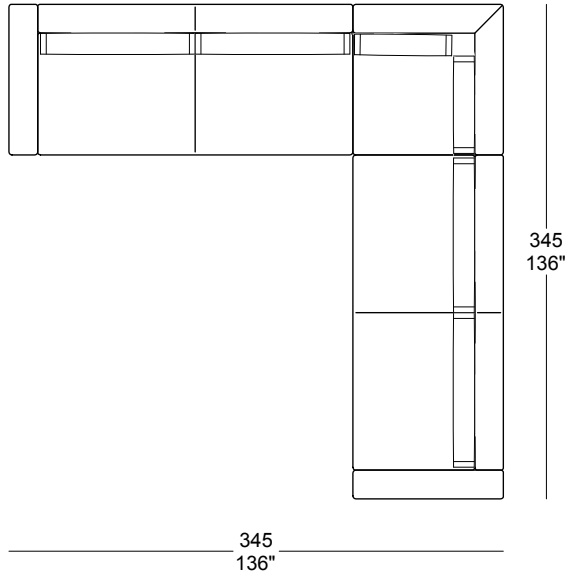

MET 77

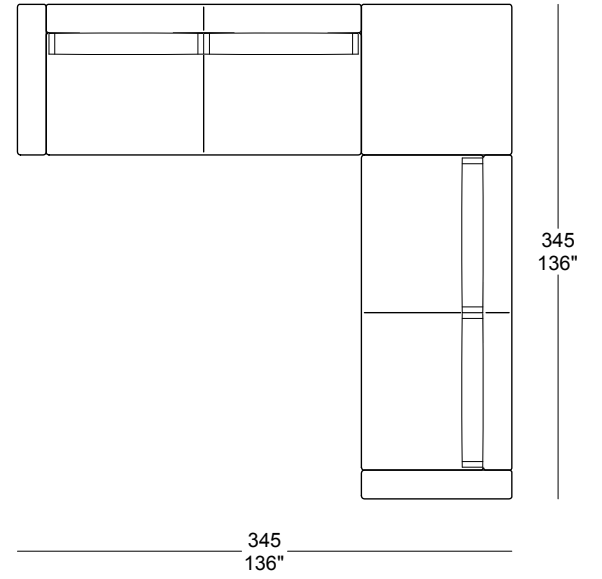

13 ▶

MET 78

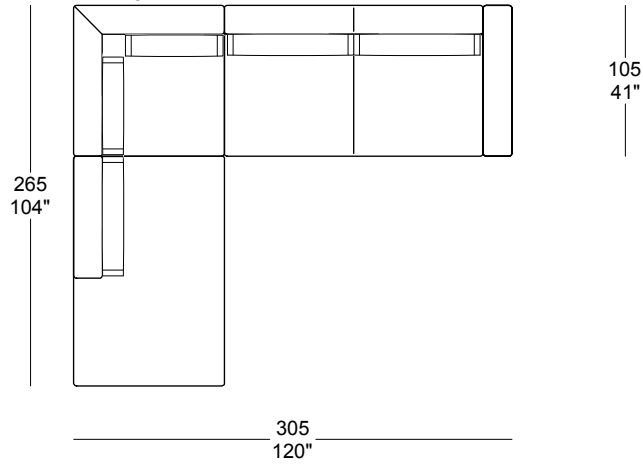

MET 79

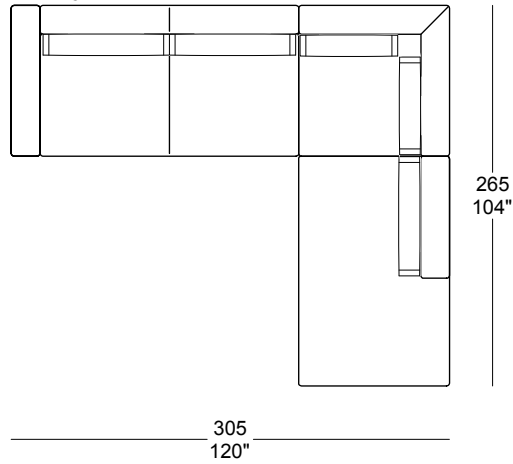

MET

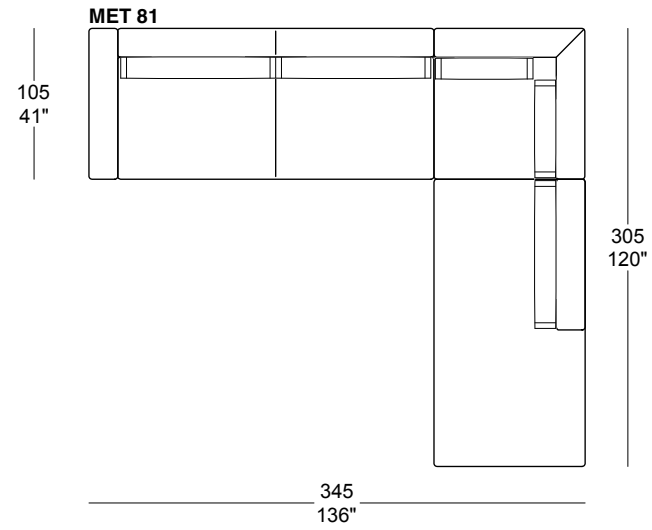
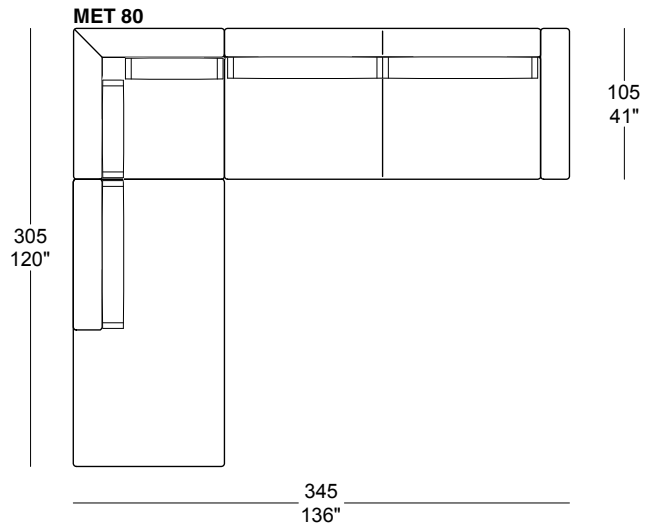

14 ►

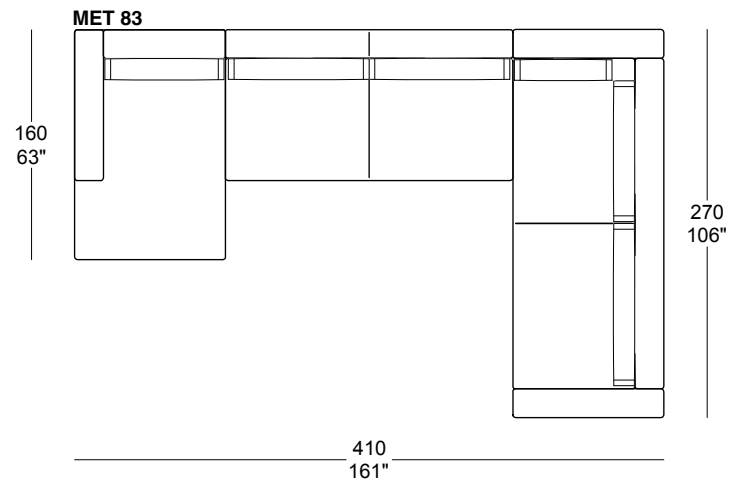
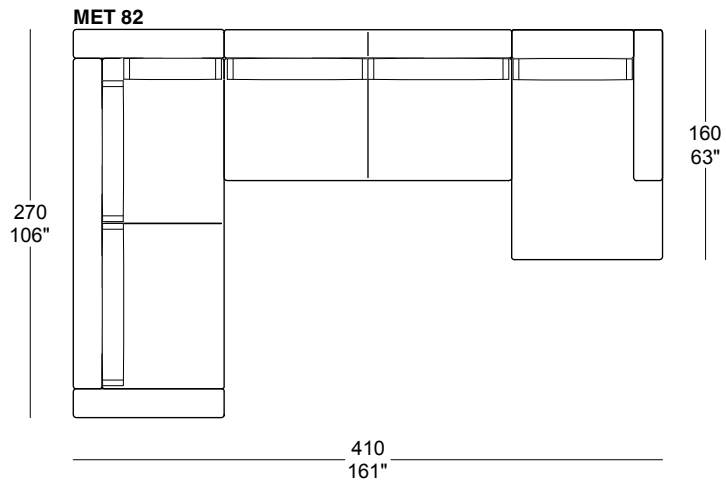

MET

MET 84

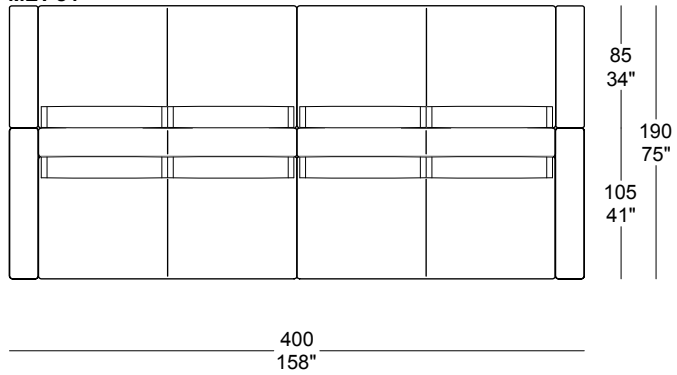

15 ►

MET 85

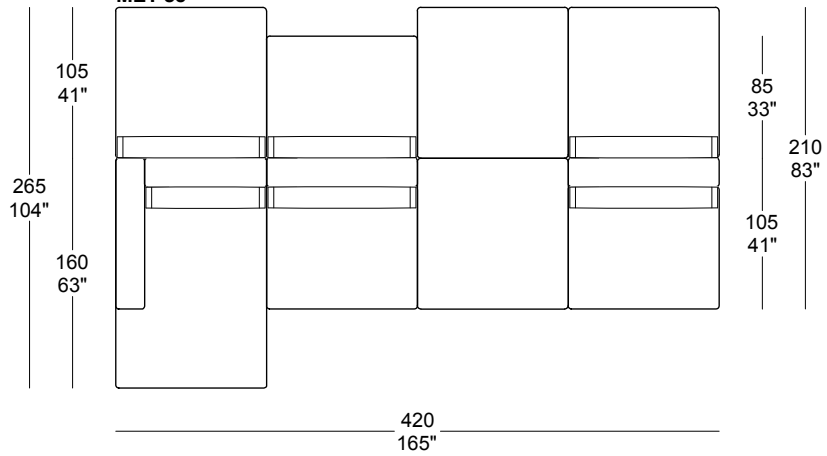

MET 86

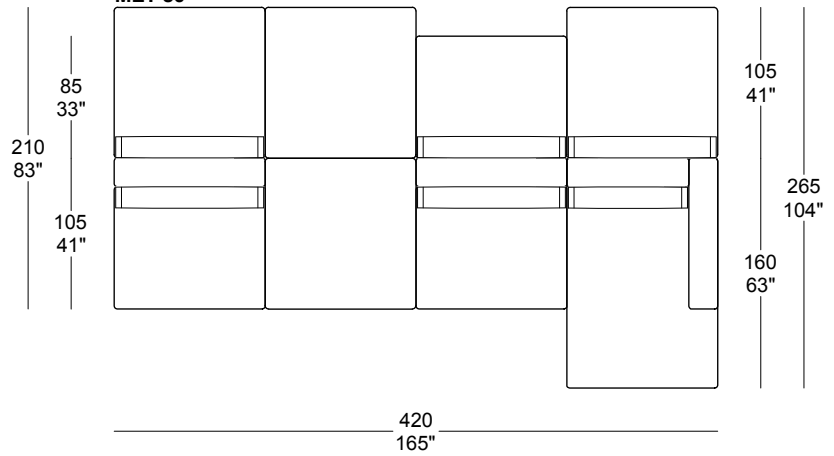

MET

MET 87

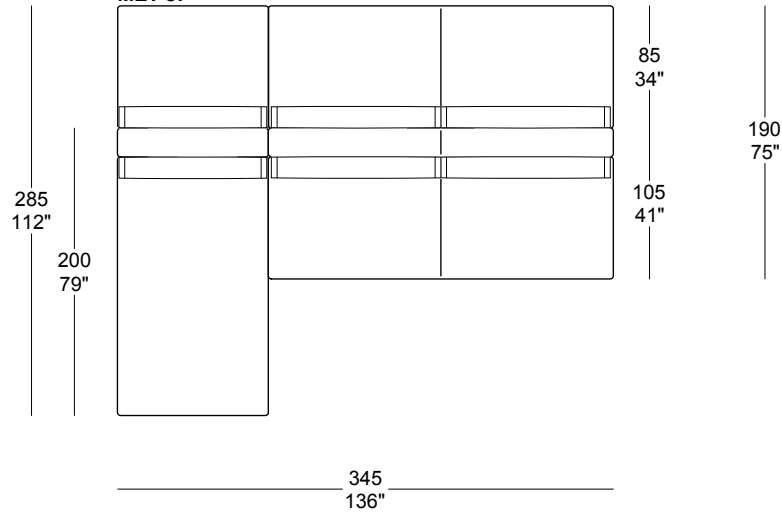

MET 88

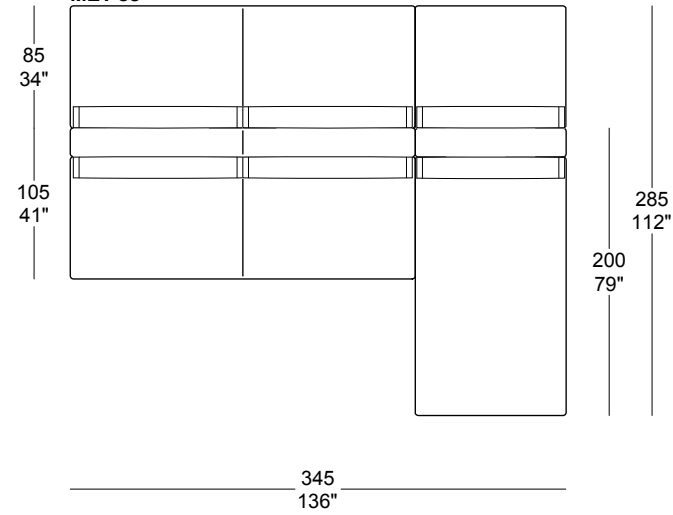

16 ▶

MET 89

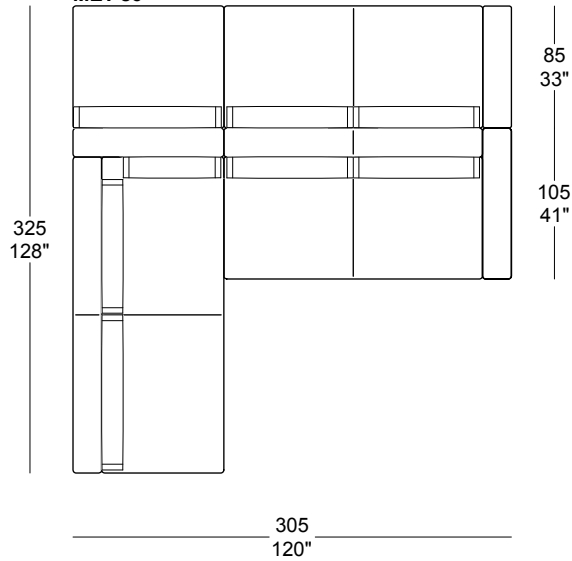

MET 90

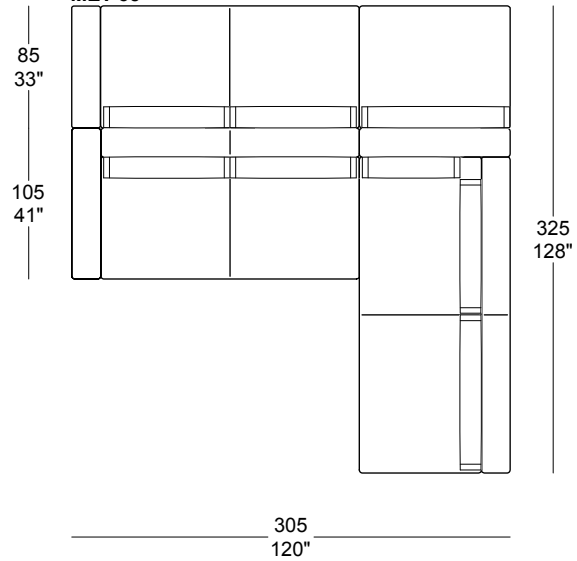

MET

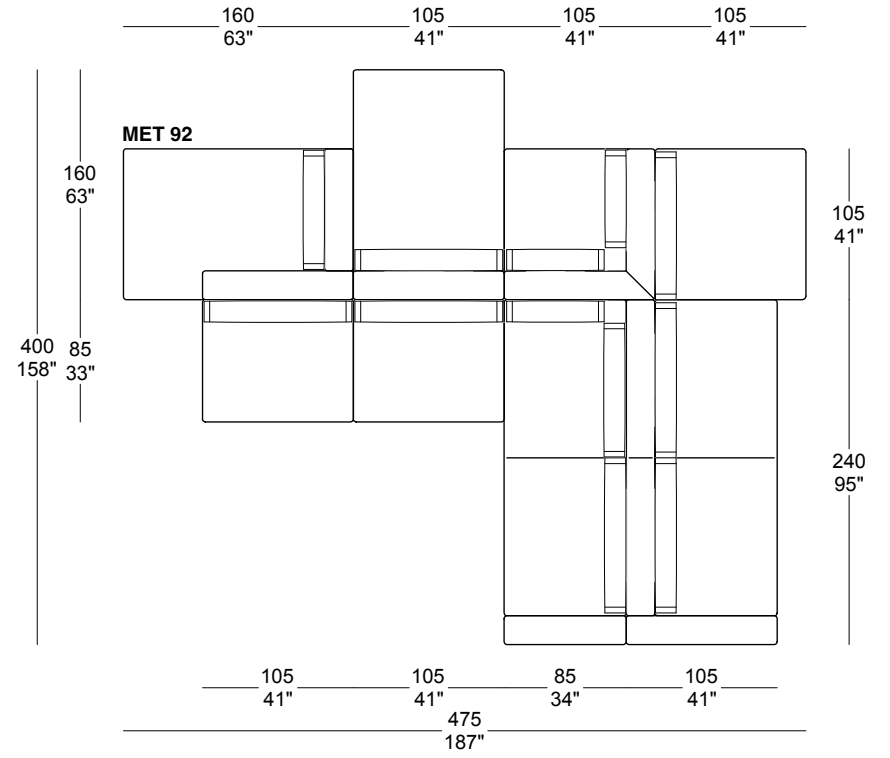
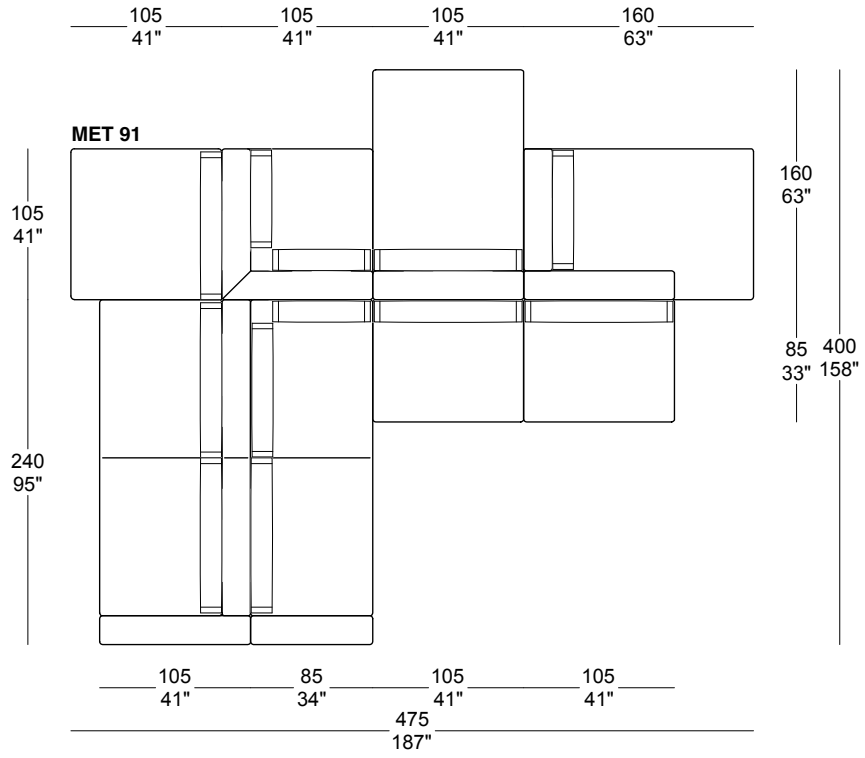

MET

MET 93

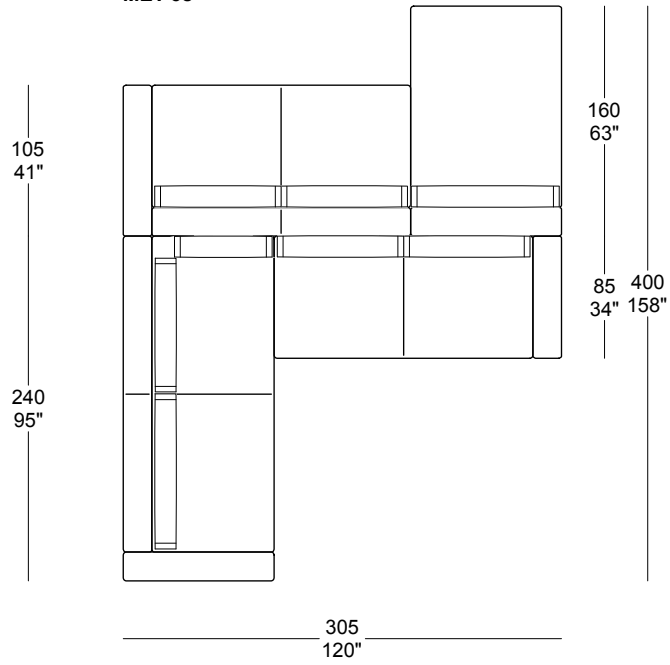

MET 94

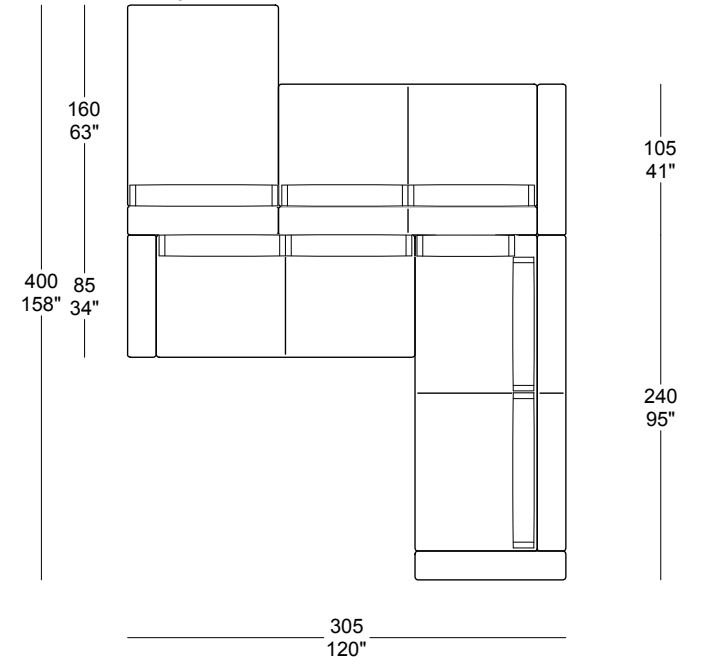



100
39"

70
28"
42
16"

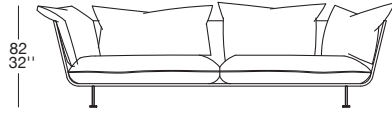

82
32"

MOO 01

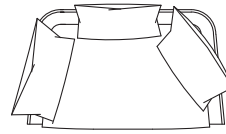

160
63"

MOO 02

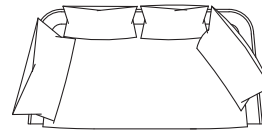

190
75"

MOO 03

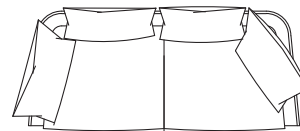

220
87"

MOO 04

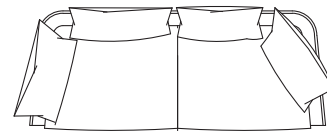

240
94"

MOO 05

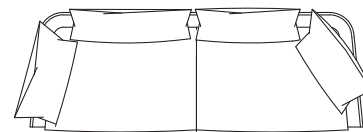

270
106"

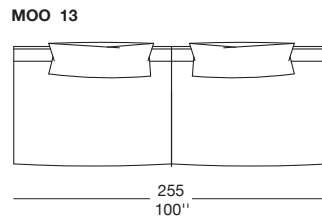
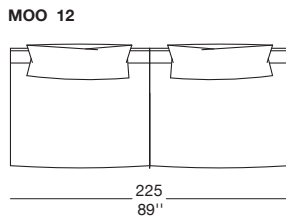
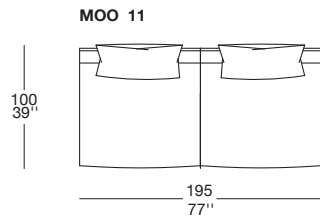
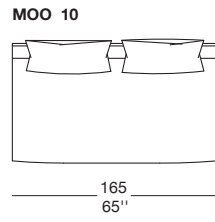
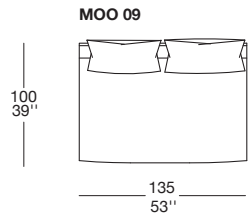
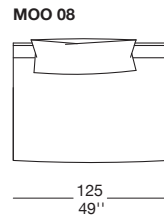
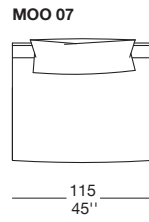
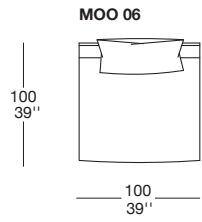

MOO 14

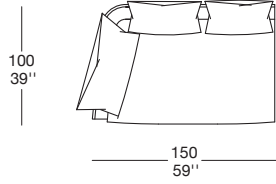

MOO 19

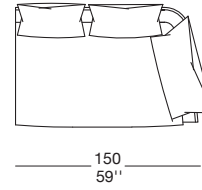

MOO 15

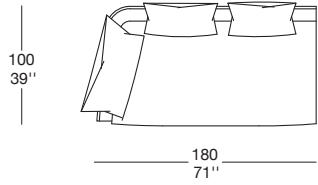

MOO 20

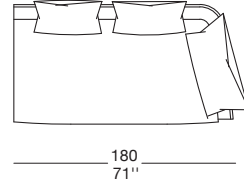

MOO 16

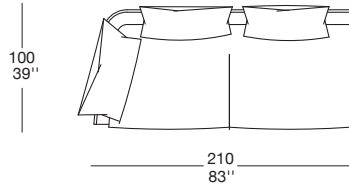

MOO 21

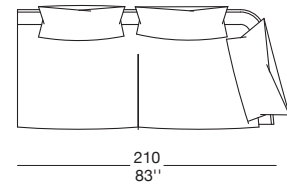

MOO 17

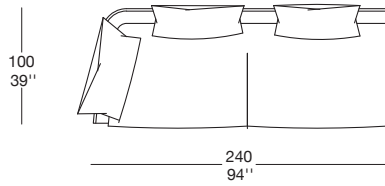

MOO 22

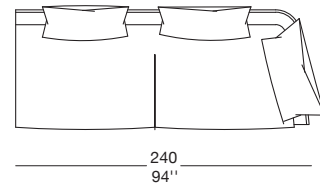

MOO 18

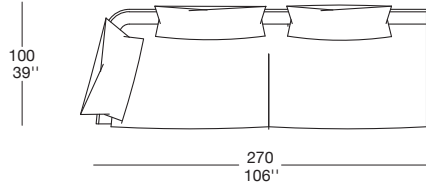

MOO 23

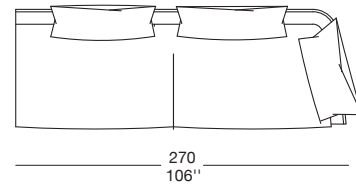

MOO 24

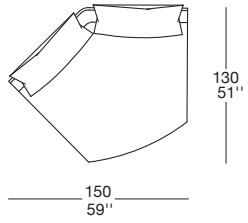

MOO 25

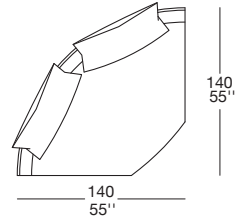

MOO 26

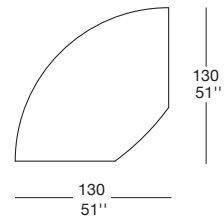

MOO 27

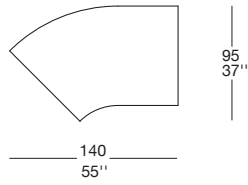

MOO 28

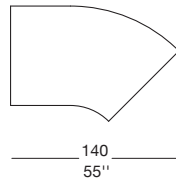

7 ▶

MOO 29

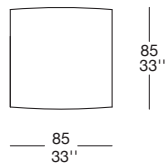

MOO 30

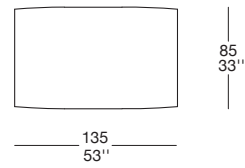

MOO 31

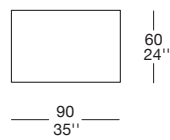

MOO 32

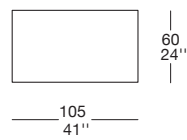

MOO 33

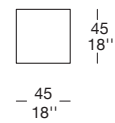

MOO 34

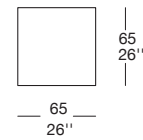

MOO 35

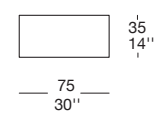

MOO 36

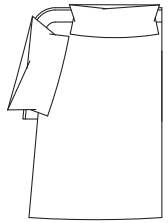

115
45"

MOO 37



115
45"

180
71"

MOO 42

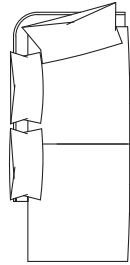

100
39"

MOO 43

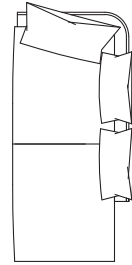

100
39"

210
83"

MOO 38

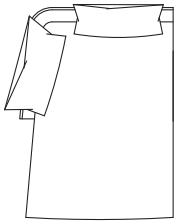

130
51"

MOO 39

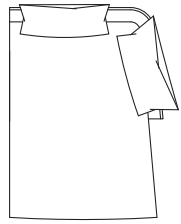

130
51"

180
71"

MOO 44

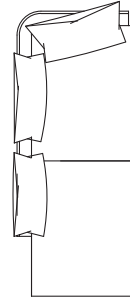

100
39"

MOO 45

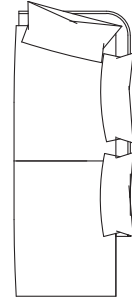

100
39"

240
94"

MOO 40

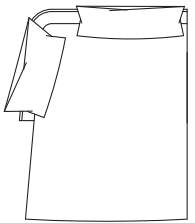

140
55"

MOO 41

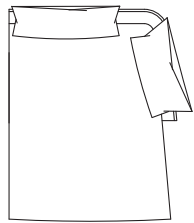

140
55"

180
71"

MOO 46

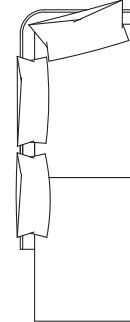

100
39"

MOO 47

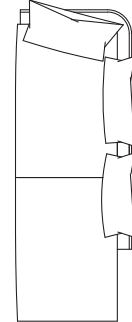

100
39"

260
102"

MOO 48

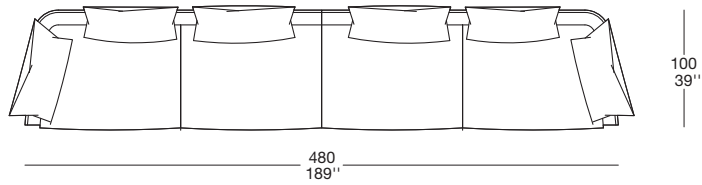

MOO 49

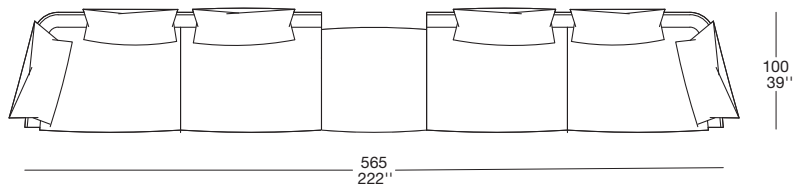

11 ►

MOO 50

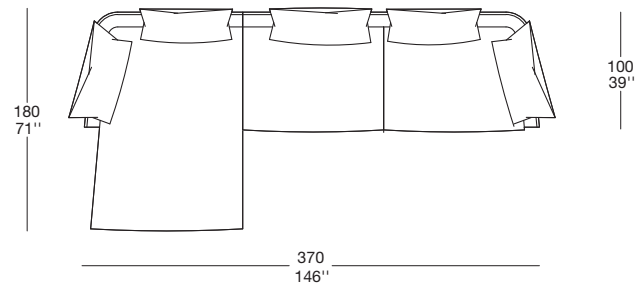

MOO 51

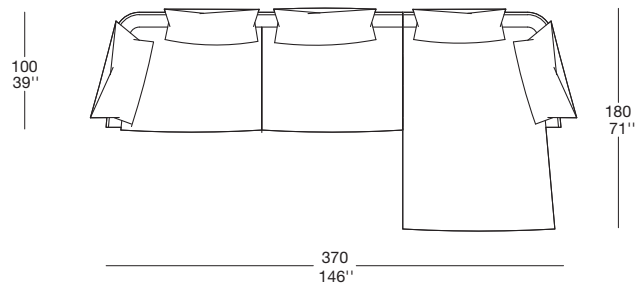

MOO 52

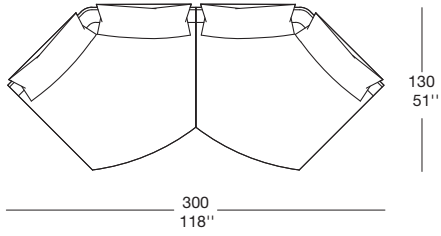

MOO 53

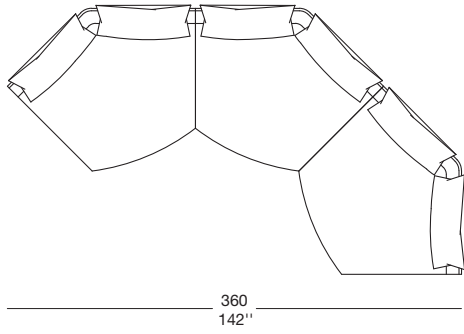

MOO 54

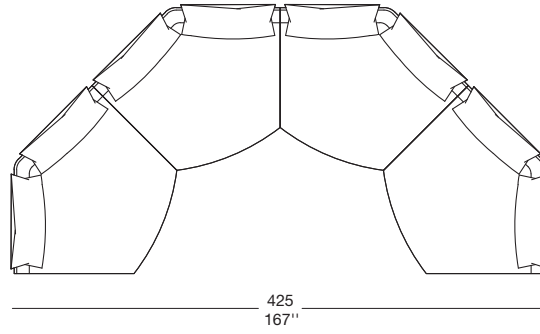

MOO 55

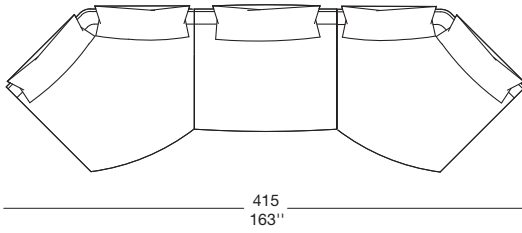

MOO 56

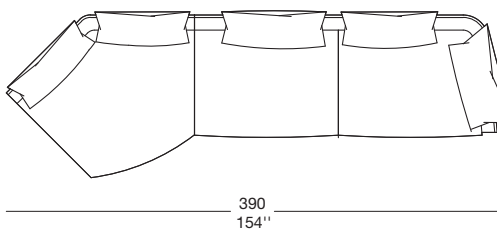

MOO 57

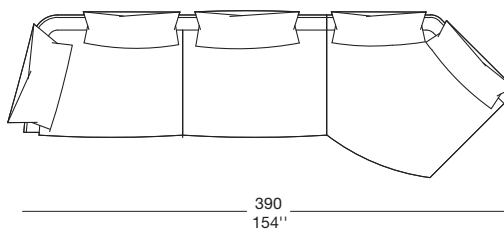

MOO 58

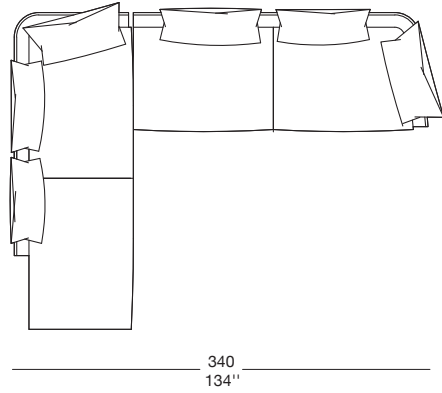

MOO 59

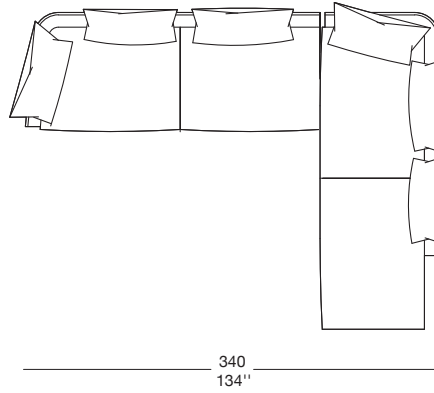

260
102"

340
134"

340
134"

15 ►

MOO 60

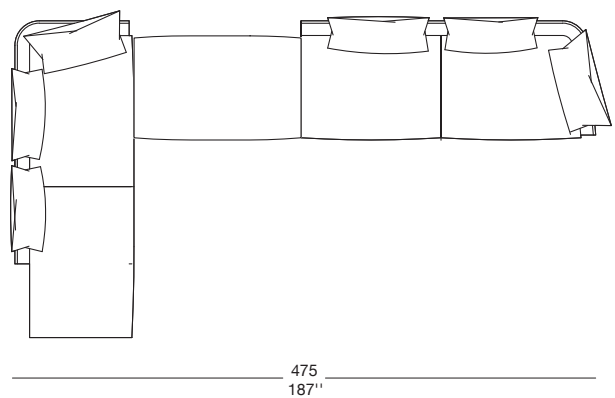

MOO 61

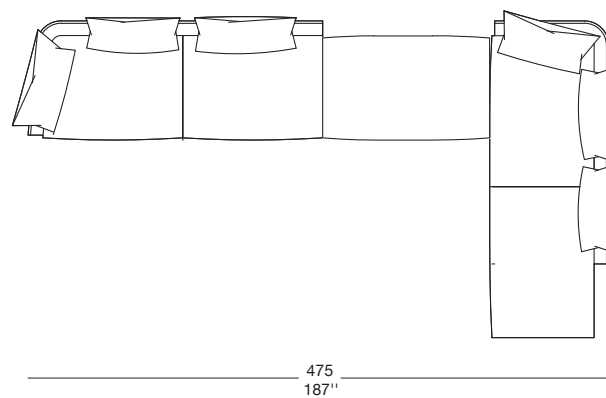

260
102"

475
187"

475
187"

MOO 62

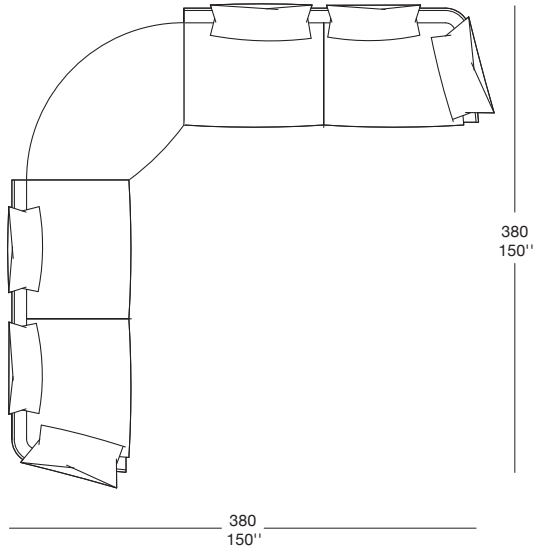

MOO 63

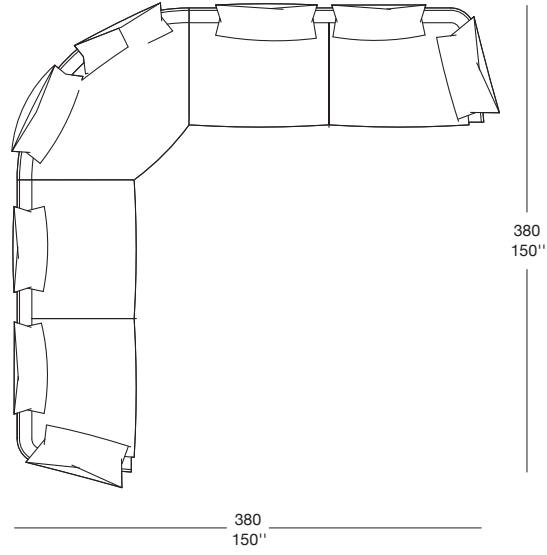

MOO 64

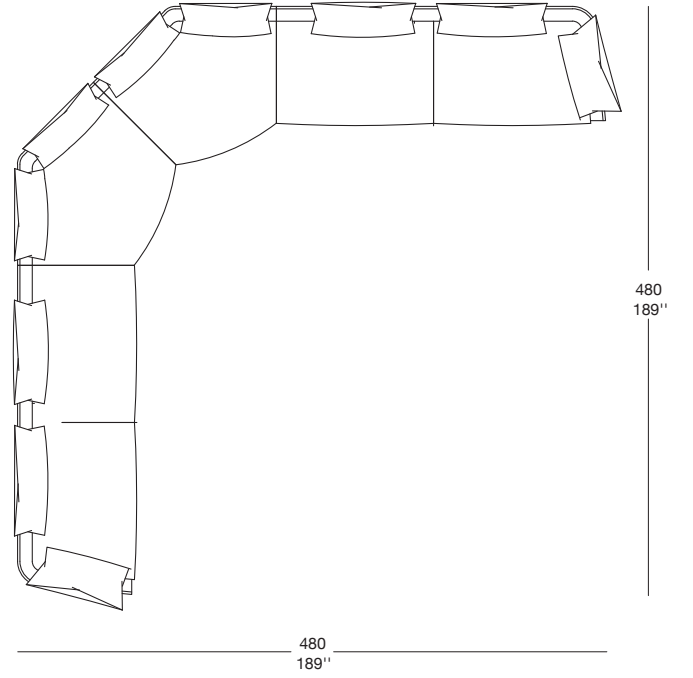

MOO 65

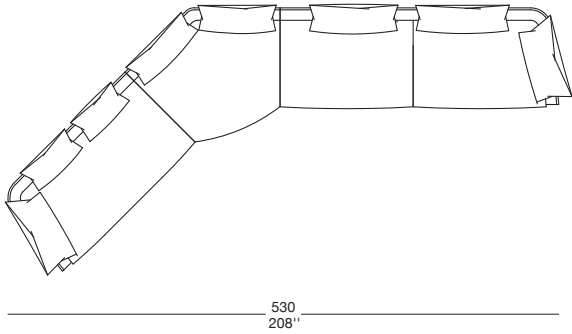

MOO 66

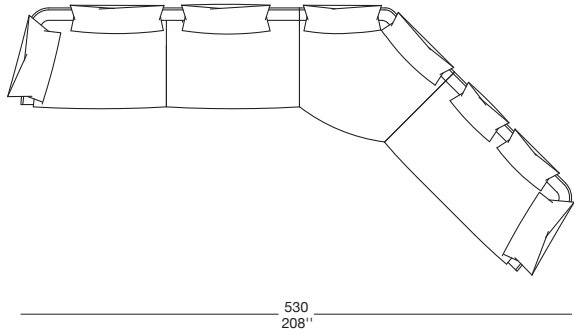

MOO 67

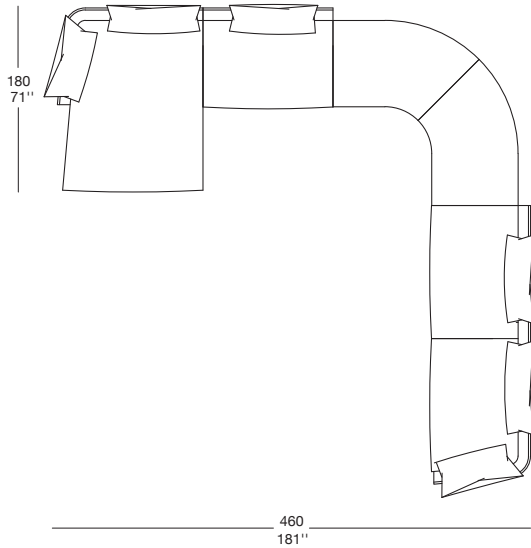

MOO 68

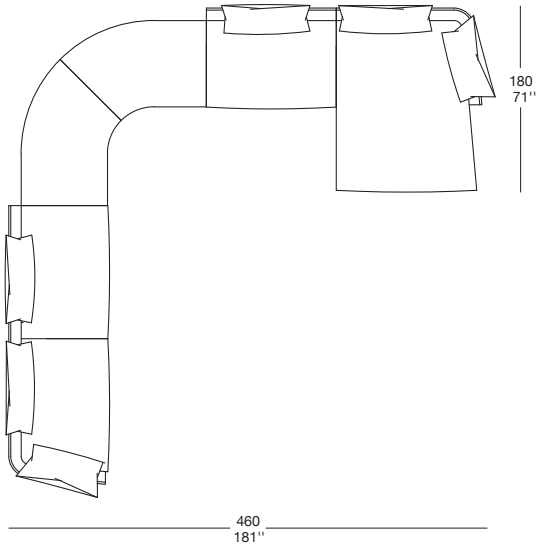

MOO 69

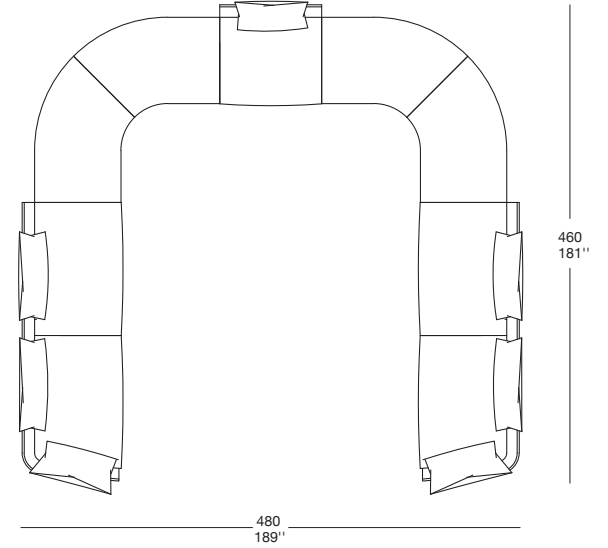

QUENTIN

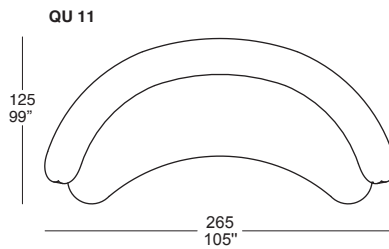
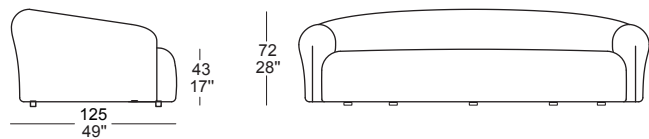
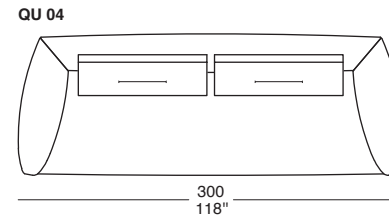
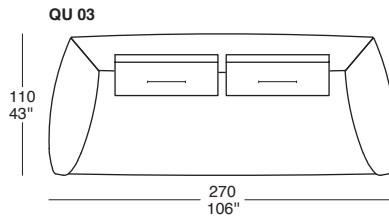
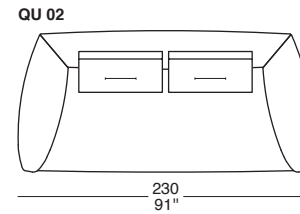
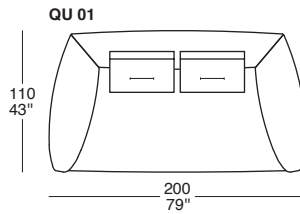
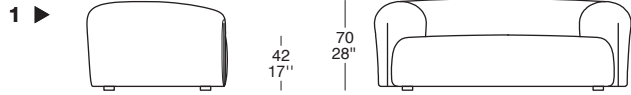
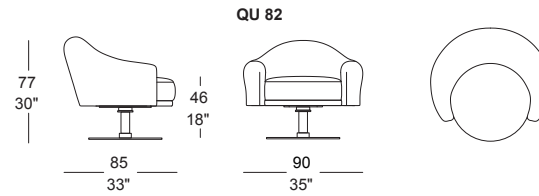
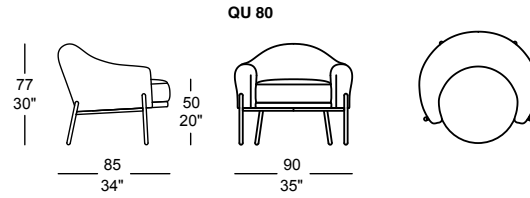
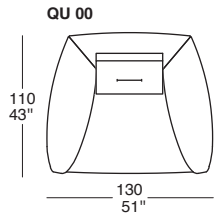
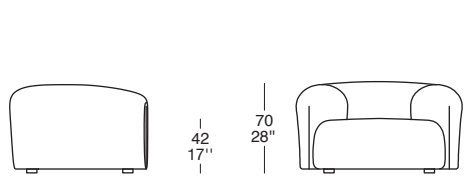

QUENTIN

BACK CUSHIONS CUSCINI SCHIENALI

QU 05

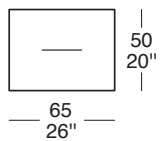

QU 06

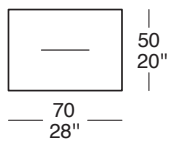

QU 07

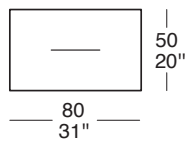

QU 08

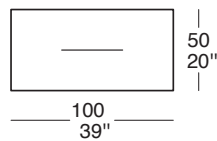

QU 09

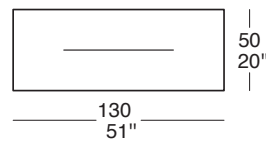

CUSHION CUSCINO

QU 10

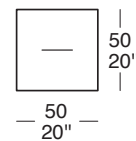

2 ▶

POUF POUF

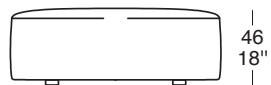

QU 27

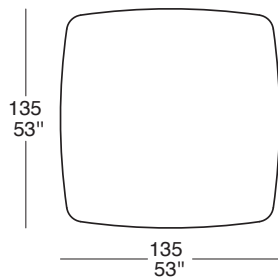

QU 28

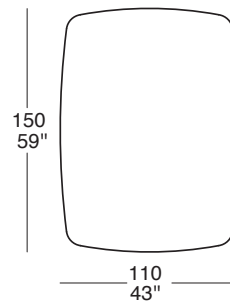

QU 38

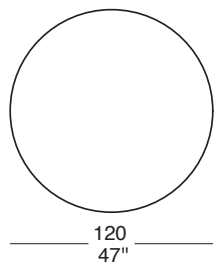
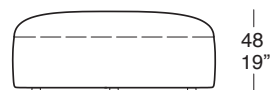

QUENTIN

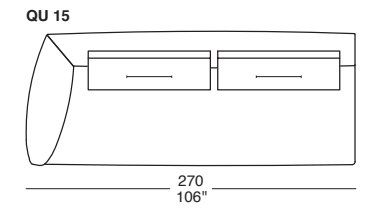
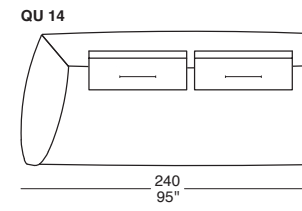
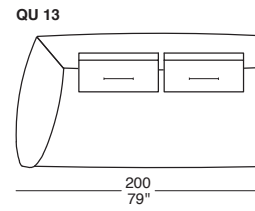
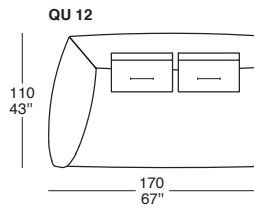
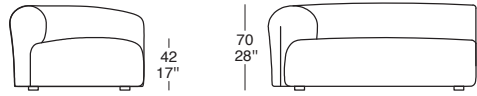

3 ▶

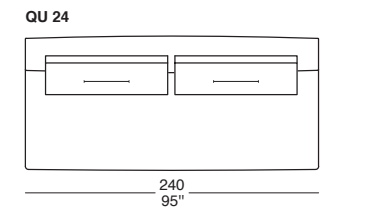
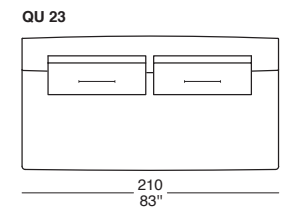
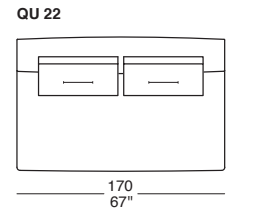
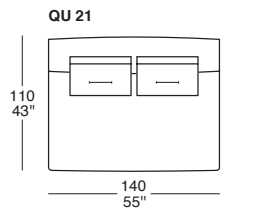
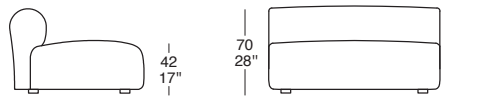
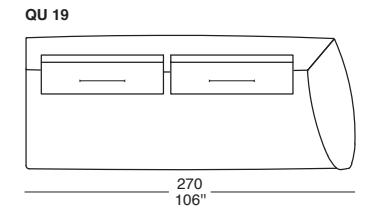
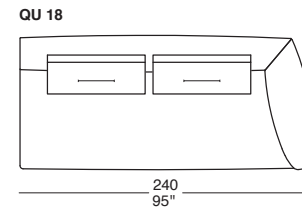
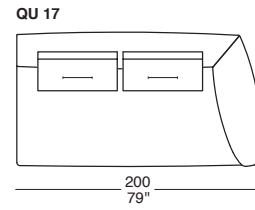
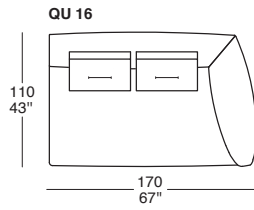
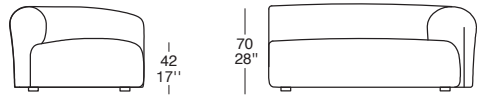

QUENTIN

QU 20

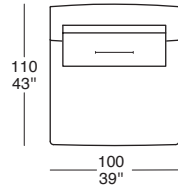

QU 25

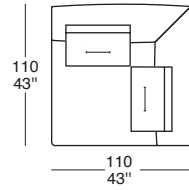

QU 26

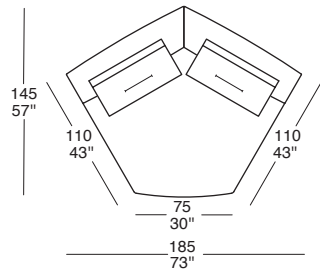

4 ▶

QU 39

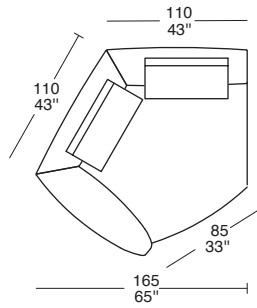

QU 40

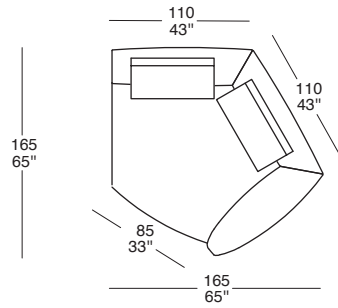

QUENTIN

QU 29

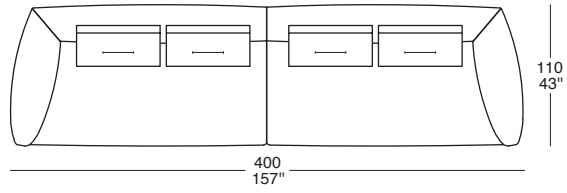

QU 30

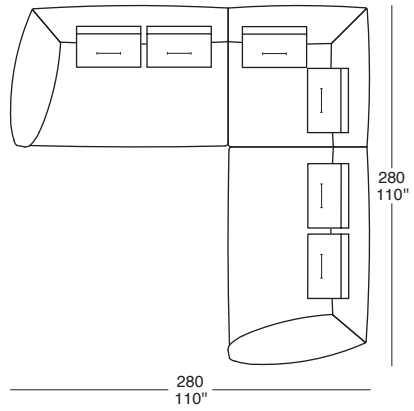

QU 31

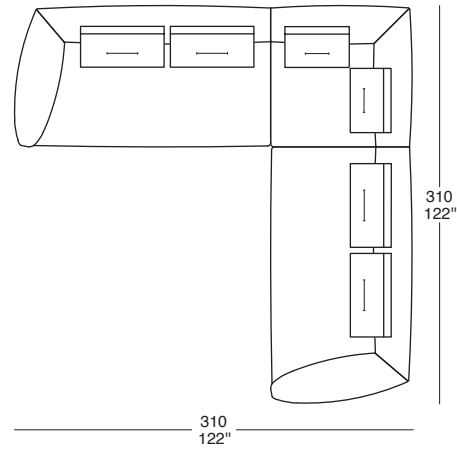

QU 32

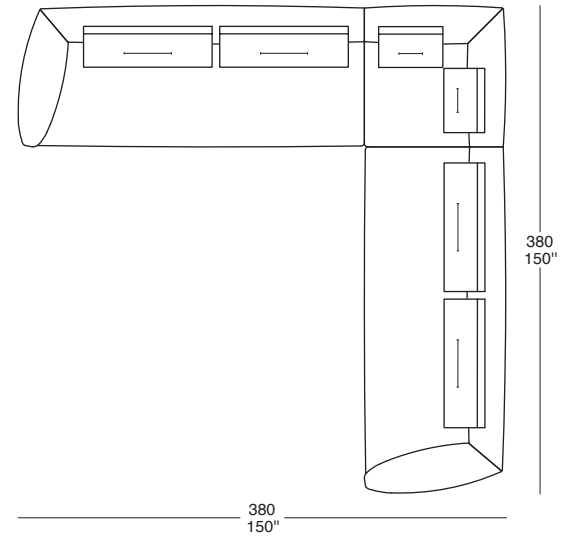

QUENTIN

QU 33

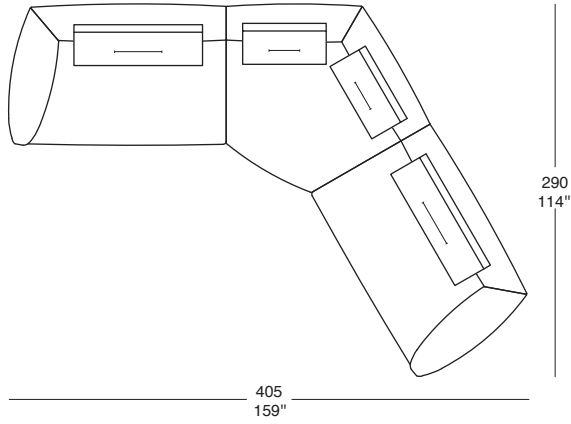

QU 34

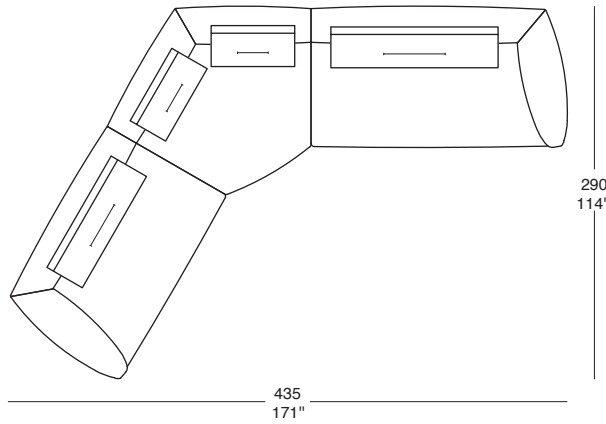

QU 35

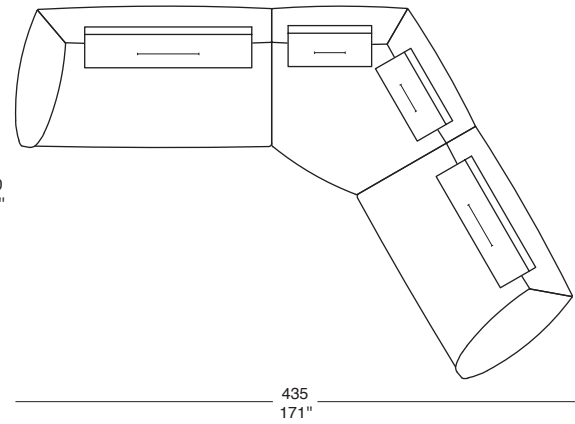

6 ▶

QU 36

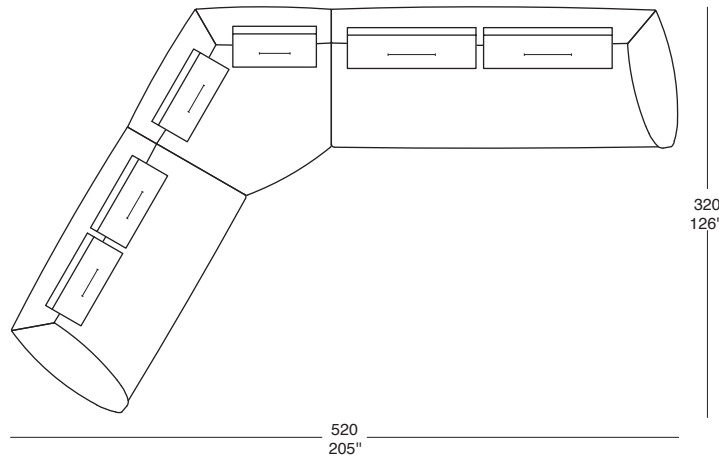

QU 37

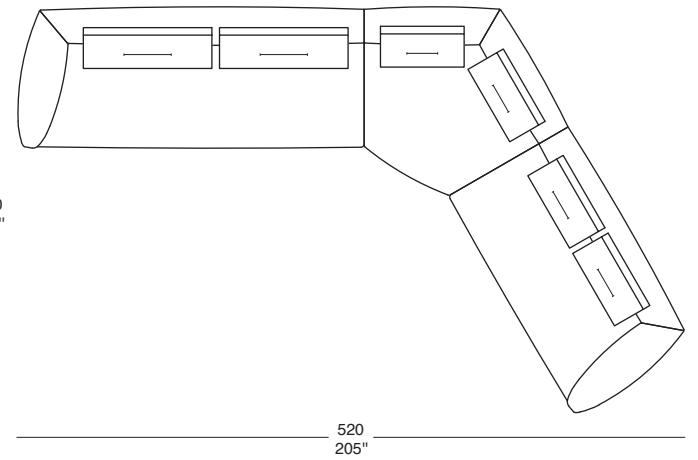

QUENTIN

QU 41

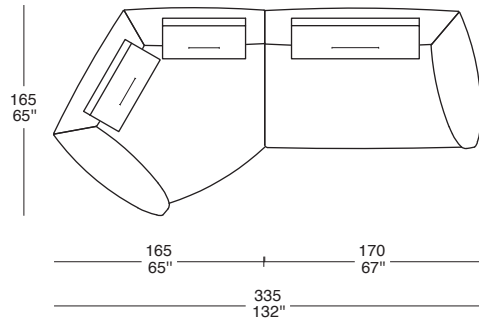

QU 42

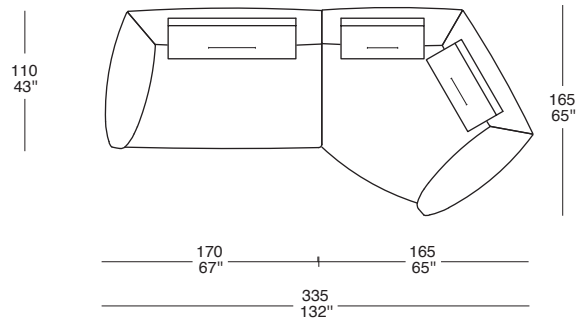

QU 43

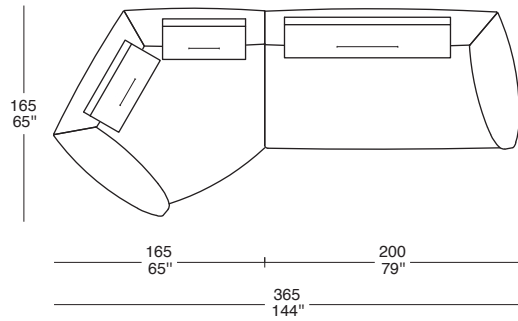

QU 44

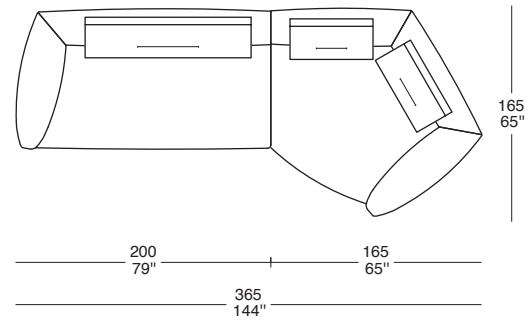

QU 45

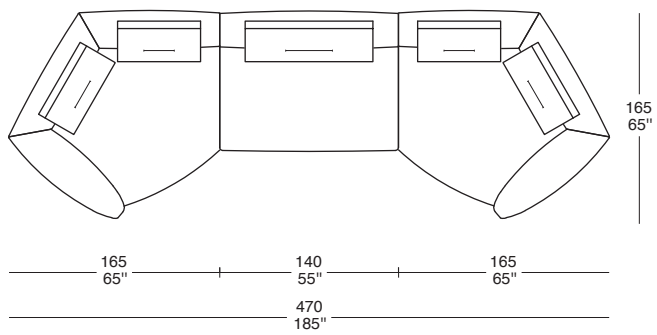

QUENTIN ANFITEATRO

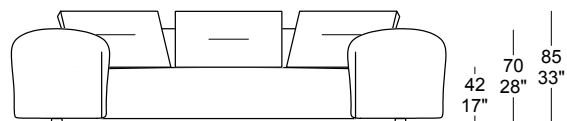

QU 46

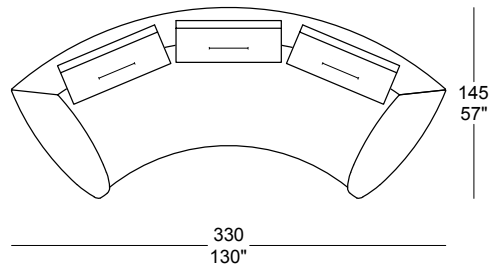

8 ▶

QU 47

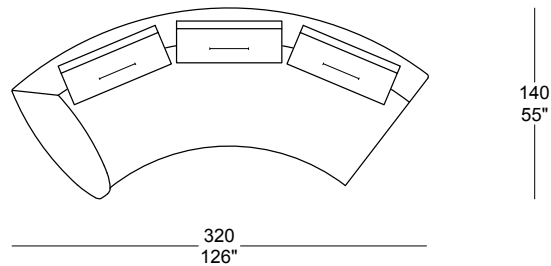

QU 48

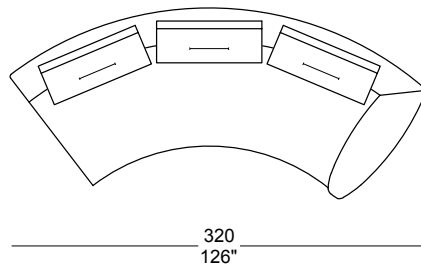

QU 49

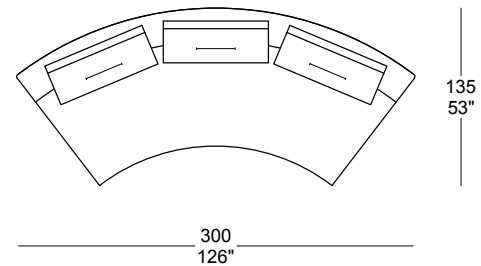

QUENTIN ANFITEATRO

QU 50

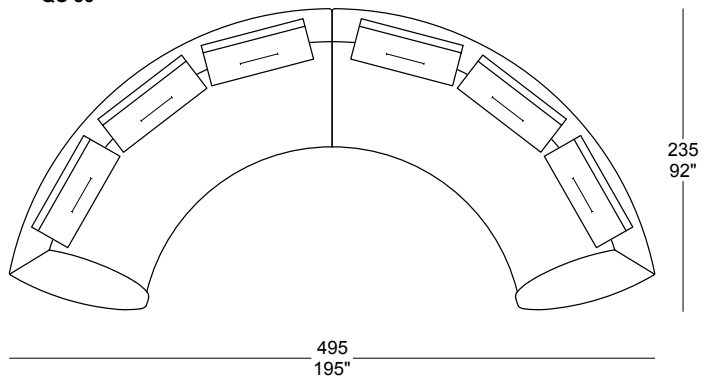

9 ▶

QU 51

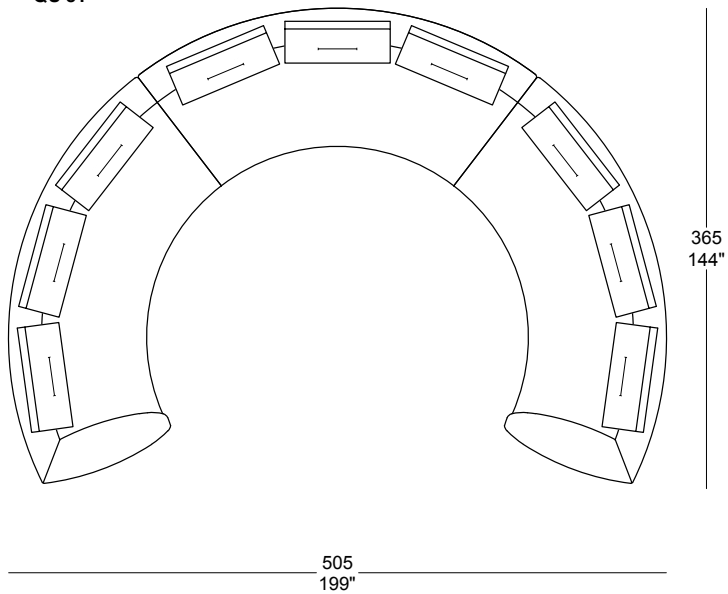

QU 52

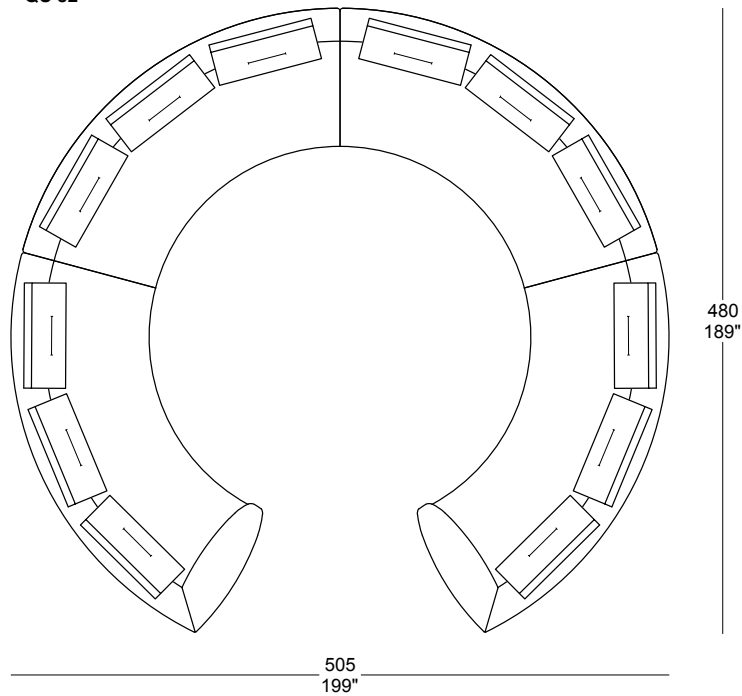

SUPER ROY CHAISE LONGUE

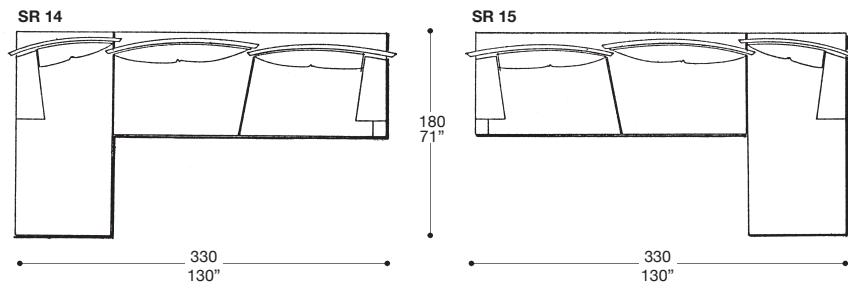
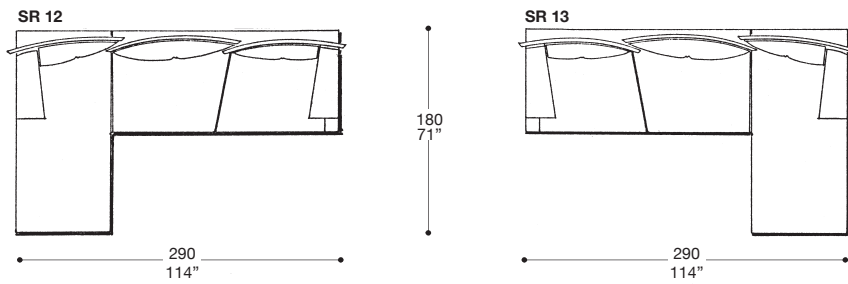
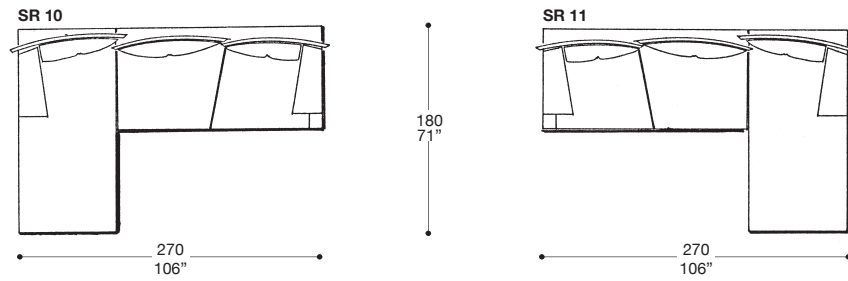
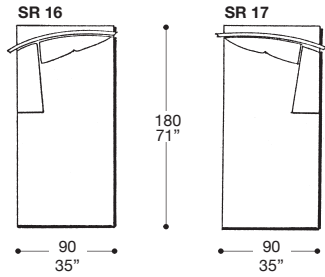

SUPER ROY ANGOLARE

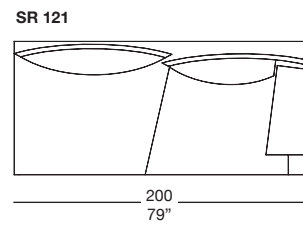
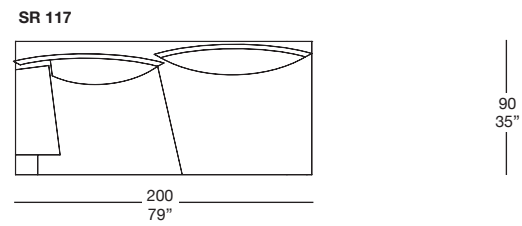
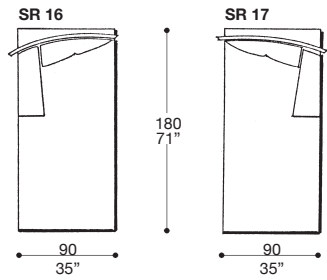

1 ▶

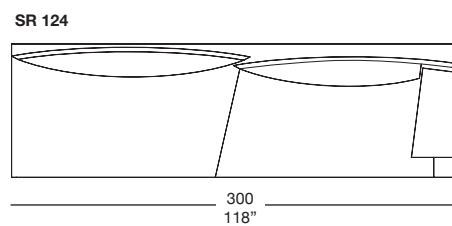
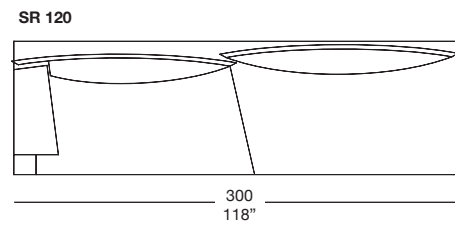
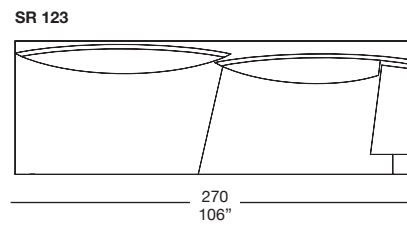
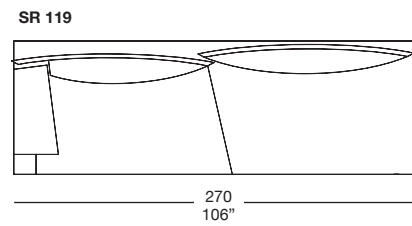
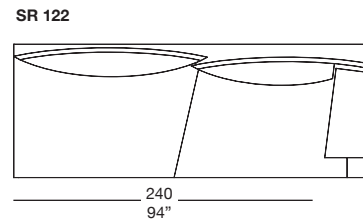
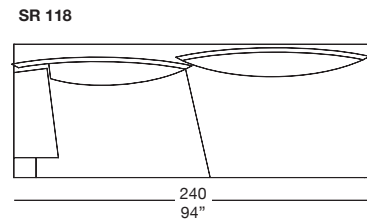

SUPER ROY ANGOLARE

SR 125

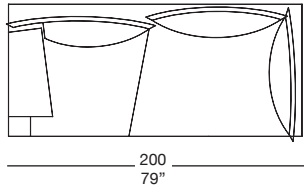

SR 129

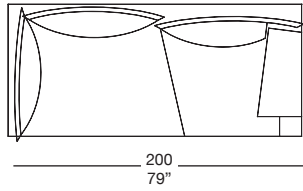

SR 126

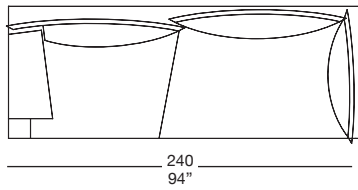

SR 130

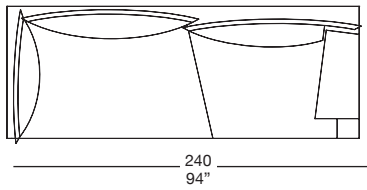

2 ▶

SR 127

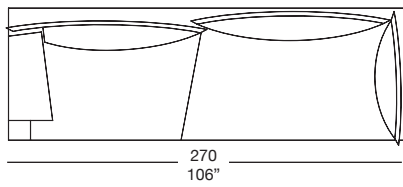

SR 131

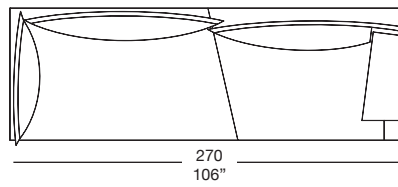

SR 128

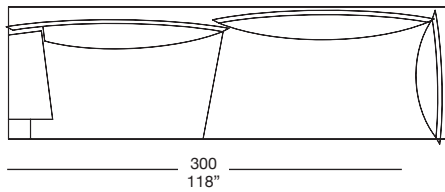

SR 132

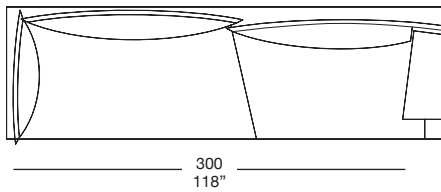

SUPER ROY ANGOLARE

SR 133

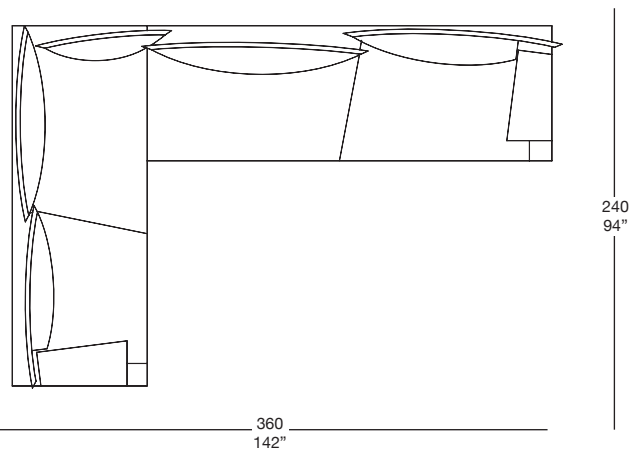

SR 134

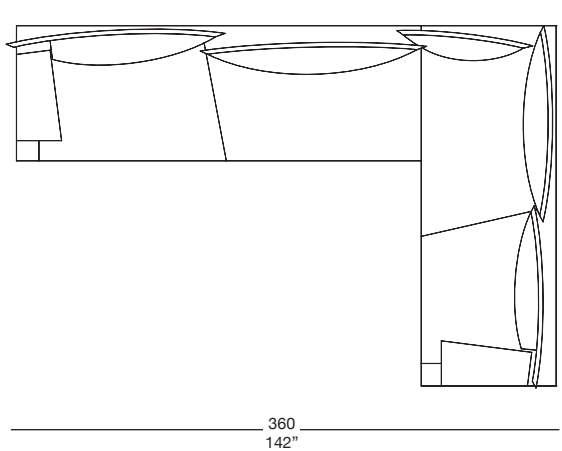

3 ▶

SR 135

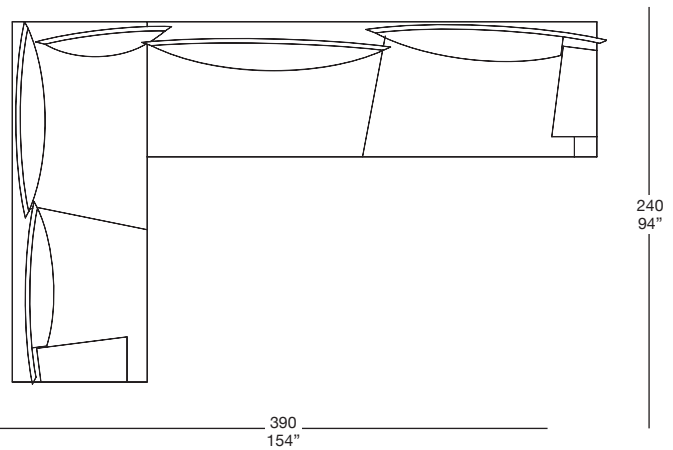

SR 136

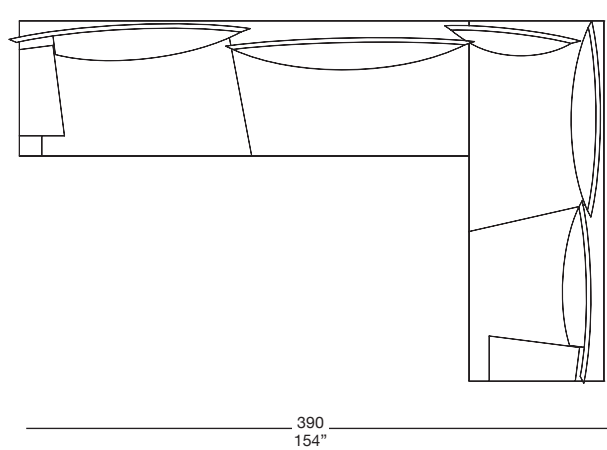

SUPER ROY ANGOLARE

SR 137

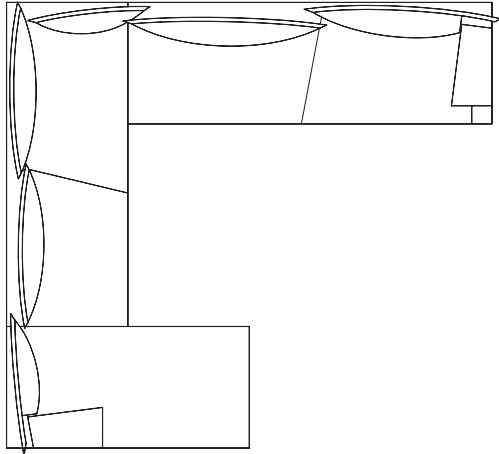

360
142"

SR 138

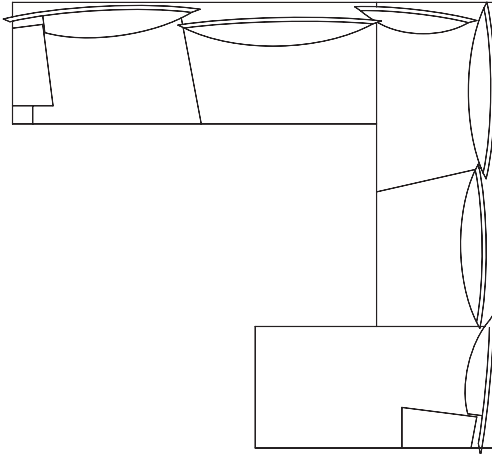

360
142"

330
130"

4 ▶

SR 139

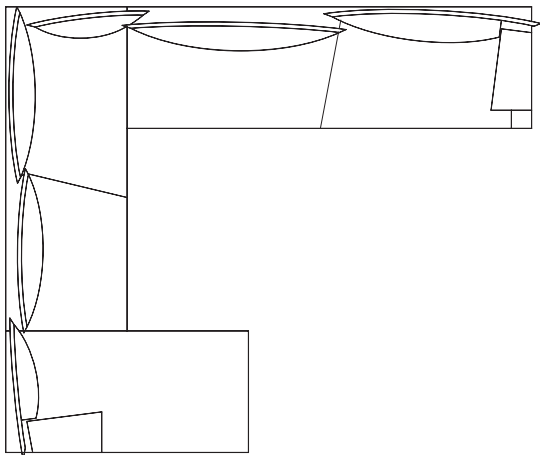

390
154"

SR 140

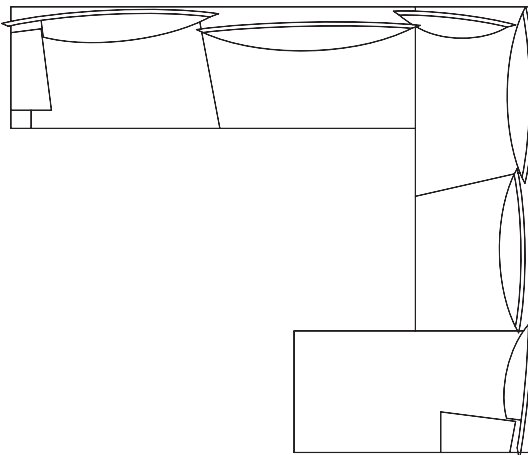

390
154"

330
130"

SUPER ROY

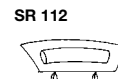
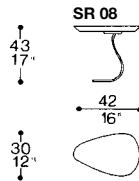
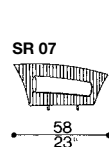
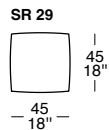
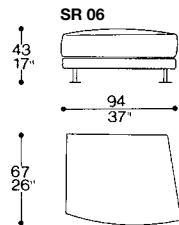
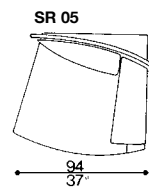
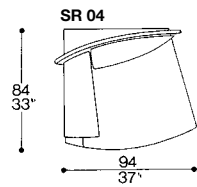
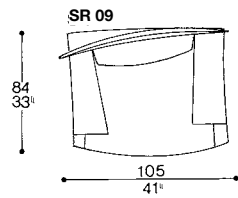
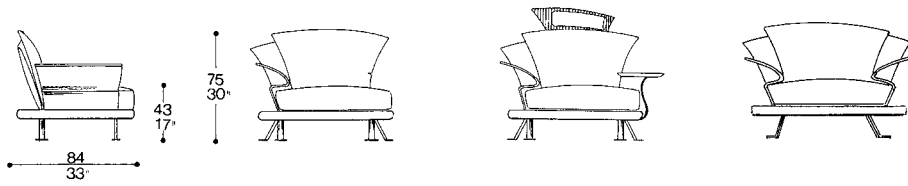

SUPER ROY

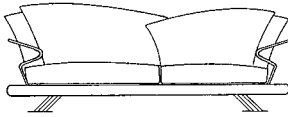
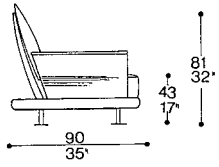

SR 01

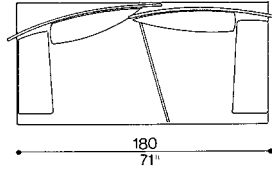

SR 02

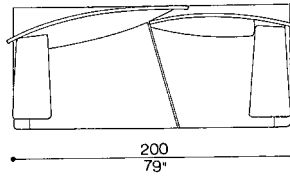

SR 03

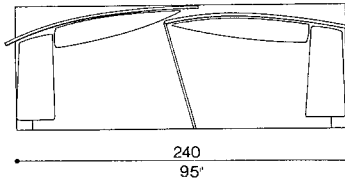

SR 18

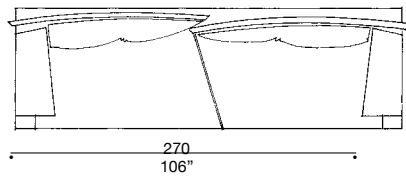

SR 19

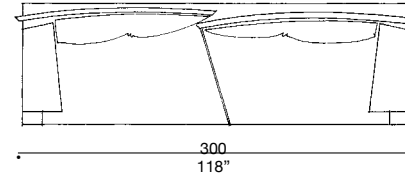

SUPER ROY ESECUZIONE SPECIALE C.L.

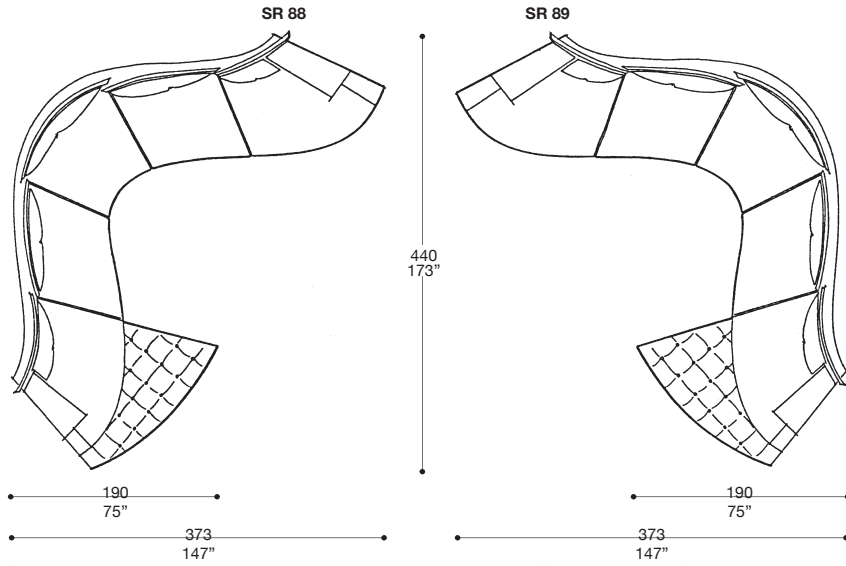

1 ►

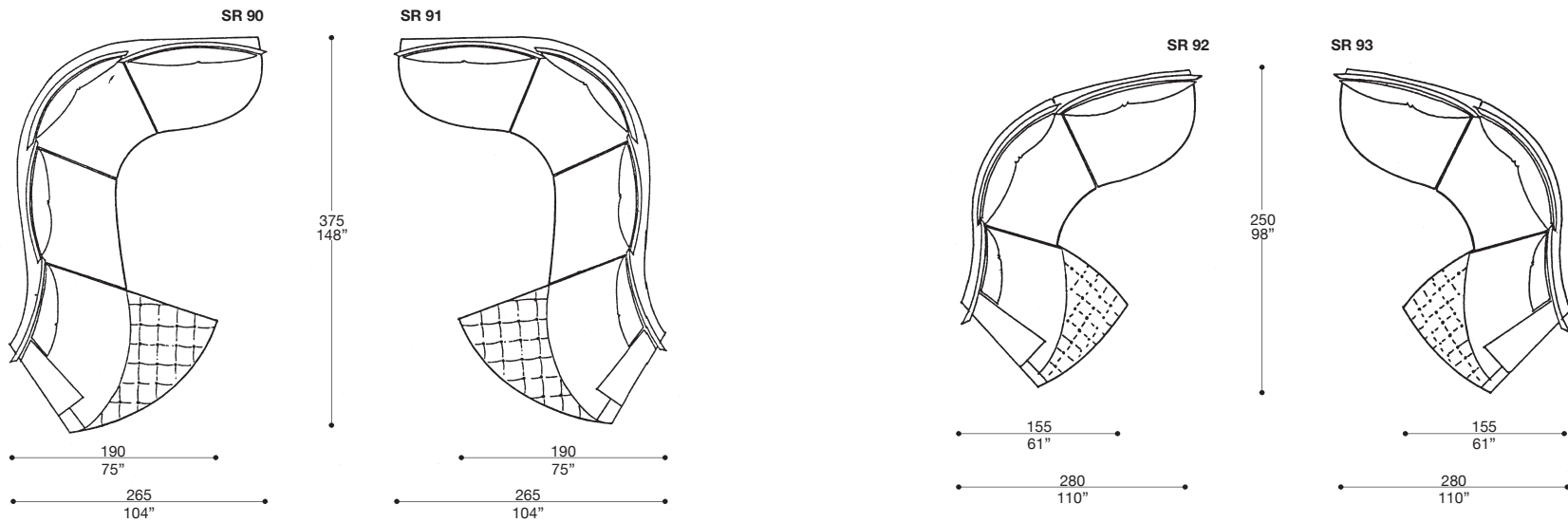

SUPER ROY ESECUZIONE SPECIALE

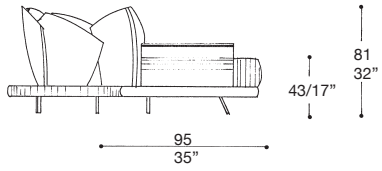

SR 80

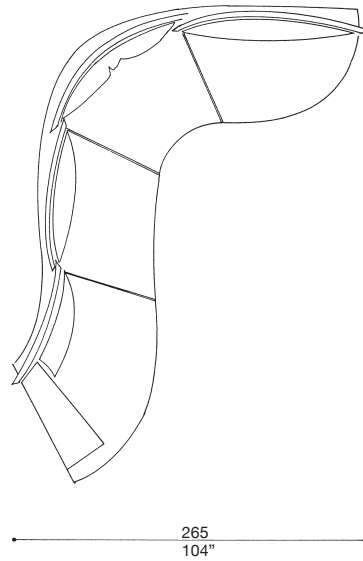

SR 81

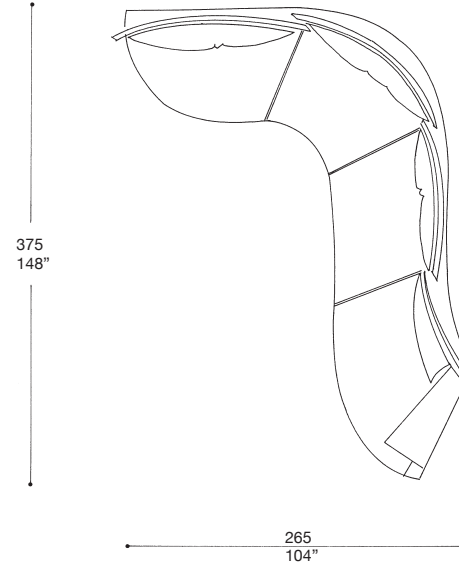

SR 101

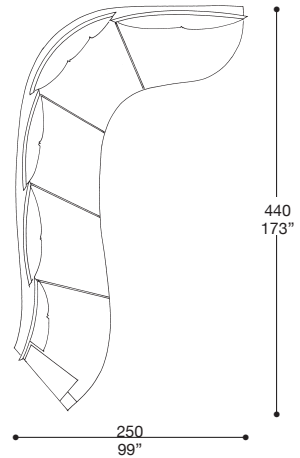

SR 102

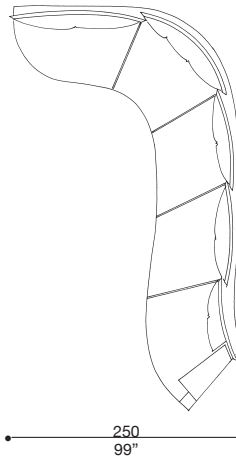

SR 86

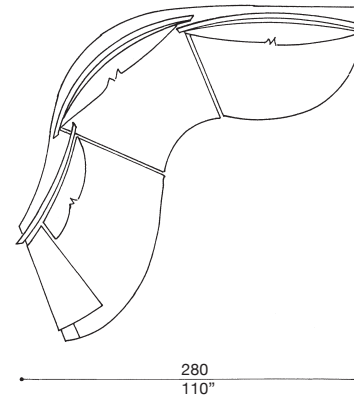

SR 87

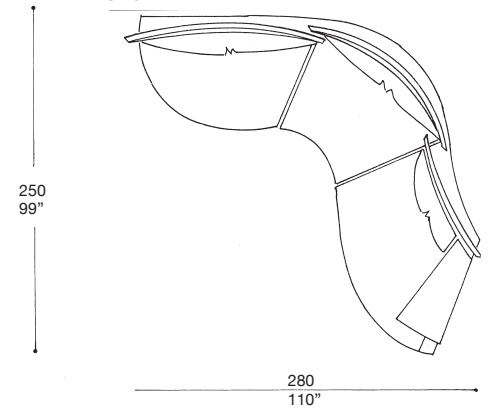

SUPER ROY ESECUZIONE SPECIALE

SR 94

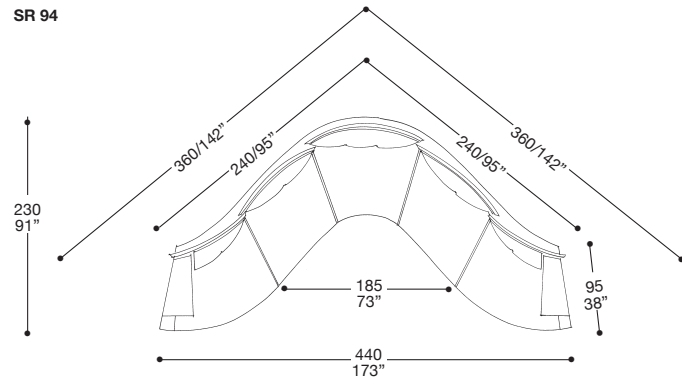

SR 116

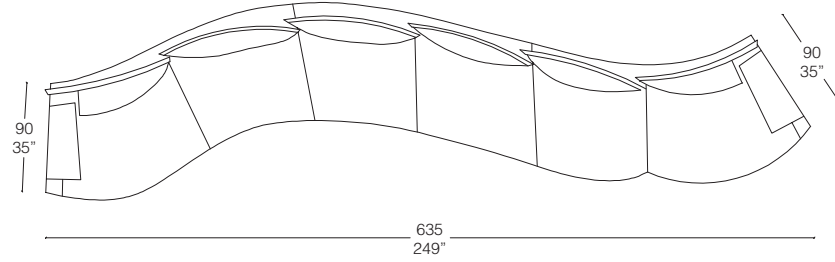

SUPER ROY ESECUZIONE SPECIALE PANORAMICO

SR 95

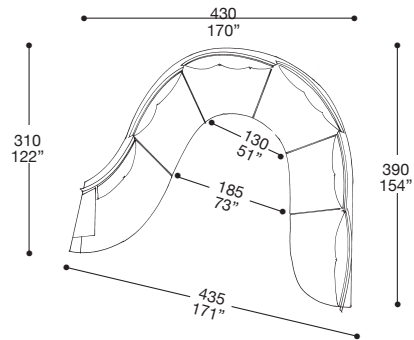

SR 96

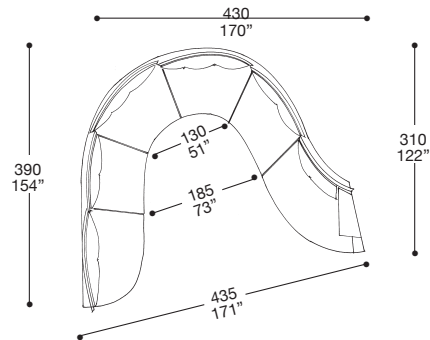

2 ▶

SUPER ROY ESECUZIONE SPECIALE ELLISSE

SR 113

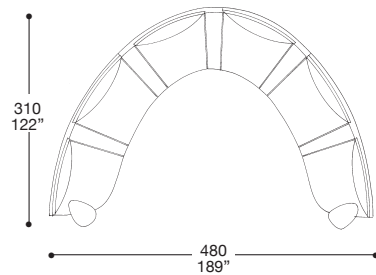

SUPER ROY ESECUZIONE SPECIALE

SR 103

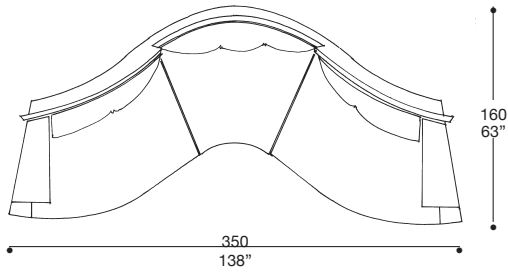

SR 104

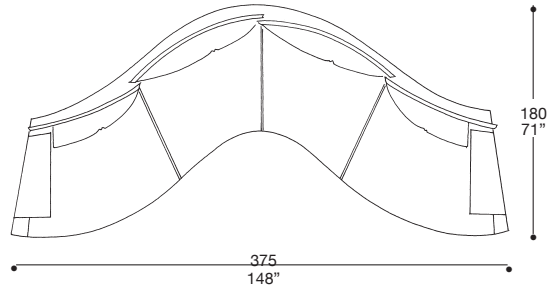

SUPER ROY ESECUZIONE SPECIALE SEMICIRCOLARE

SR 105

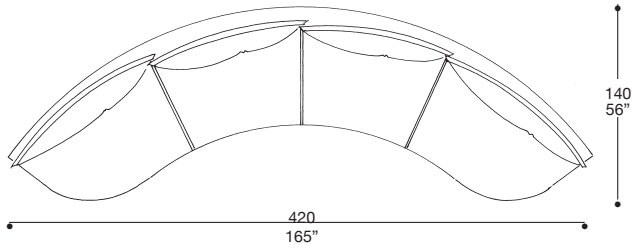

SR 106

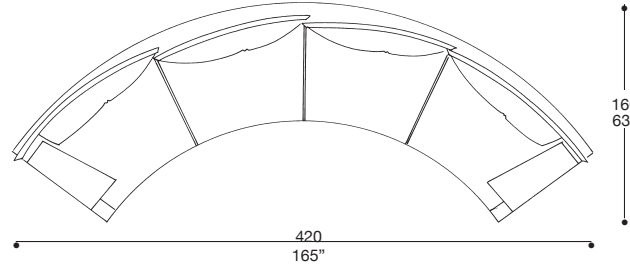

SUPER ROY ESECUZIONE SPECIALE PANORAMICO

SR 107

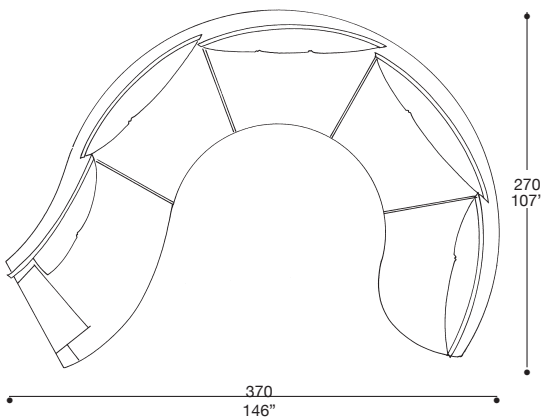

SR 108

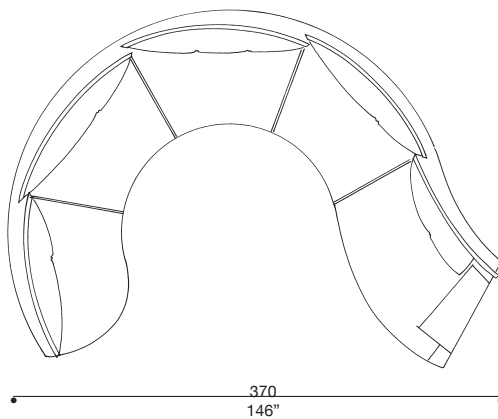

SR 109

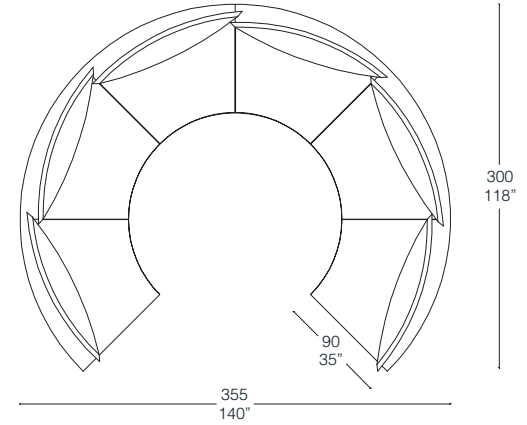

SUPER ROY ESECUZIONE SPECIALE

SR 114

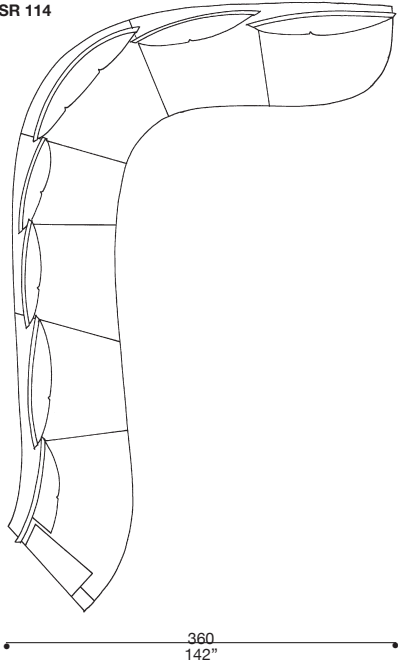

SR 115

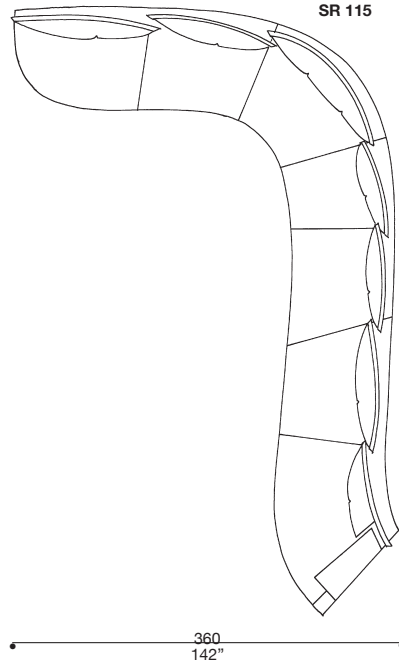

4 ▶

SR 82

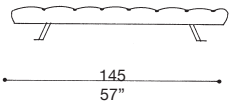

23 3/9"

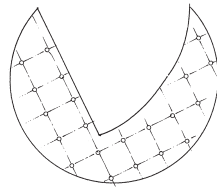

SR 83

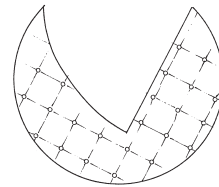

SR 84

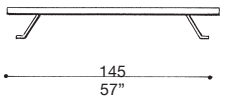

23 3/9"

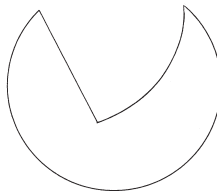

SR 85

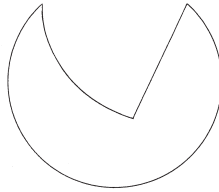

SUPER ROY ESECUZIONE SPECIALE

SR 141

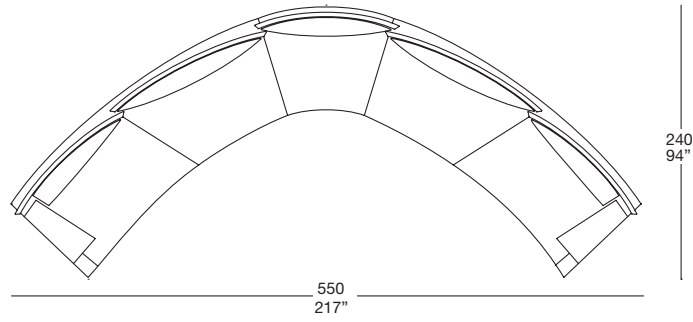

SR 142

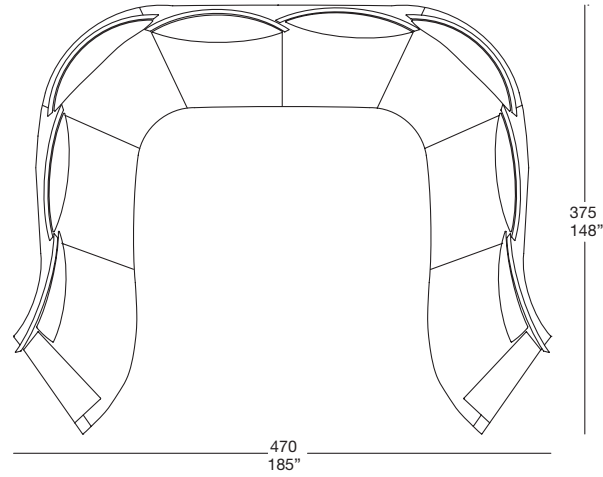

SR 143

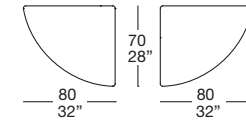

SR 144

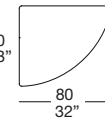

5 ▶

SR 145

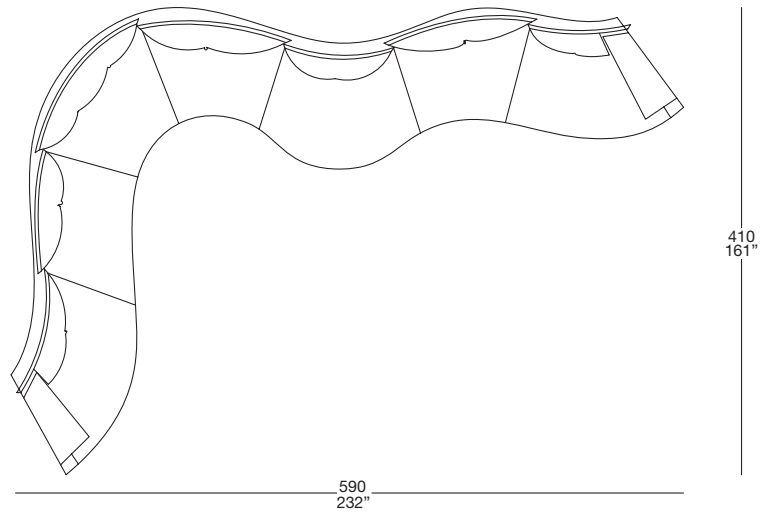

SR 146

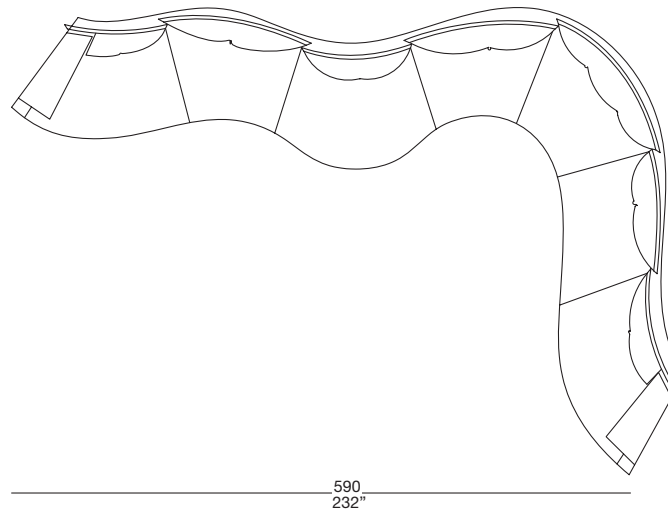

SR 147

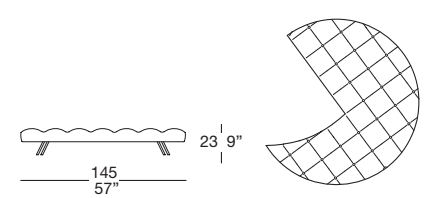

SR 148

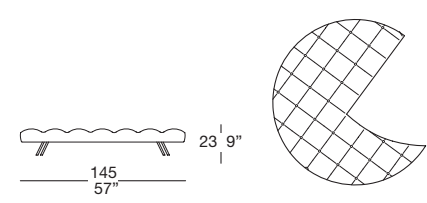

SUPER ROY ESECUZIONE SPECIALE PENISOLA

SR 110

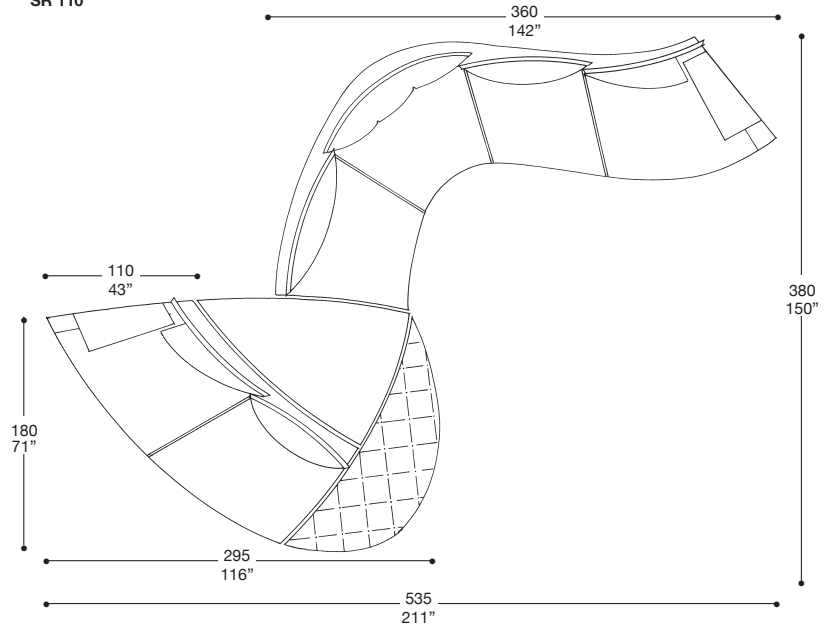

1 ►

SR 221

